

# BELCO RESOURCES EQUIPMENT

Quality Products for  
Your Land, from  
Brands you Love!



## SUGGESTED RETAIL PRICEBOOK

JULY 2024

NOTE: DUE TO MANUFACTURER TRADE AGREEMENTS, SOME PRODUCTS MIGHT NOT BE AVAILABLE IN CERTAIN AREAS.  
PLEASE CHECK WITH YOUR TERRITORY REPRESENTATIVE FOR MORE DETAILS.

# DEALER RESOURCES

## SALES

Email:	sales@br-equipment.com (general inquiries) orders@br-equipment.com (place whole goods orders via email)
Phone:	(252) 822-7140 Option 1
Fax:	(252) 787-5855

## ACCOUNTING

Email:	accounts@br-equipment.com
Direct Phone:	(252) 822-7140 Option 4
Fax:	(252) 787-5855

## PARTS

Email:	parts@br-equipment.com (inquiry and place parts orders)
Direct Phone:	(252) 822-7140 Option 2
Fax:	(252) 787-5855

## WARRANTY/SERVICE

Email:	service@br-equipment.com warranty@br-equipment.com
Direct Phone:	(252) 822-7140 Option 3
Fax:	(252) 787-5855

## SHIPPING

Email:	shipping@br-equipment.com (freight quotes, tracking, shipping issues)
Direct Phone:	(252) 316-2121 (252) 557-4822

## MANUALS & BROCHURES

Website	<a href="http://www.br-equipment.com">www.br-equipment.com</a>
---------	----------------------------------------------------------------

## ONLINE DEALER ACCESS

Login Information	See your Sales Representative
-------------------	-------------------------------

What you can access here:	<ul style="list-style-type: none"><li>◇ Whole goods Order Forms</li><li>◇ Parts Order Forms</li><li>◇ Brochure Request Forms</li><li>◇ Warranty Registration Forms</li><li>◇ Warranty Claim Forms</li></ul>
---------------------------	-------------------------------------------------------------------------------------------------------------------------------------------------------------------------------------------------------------

# CONTENTS BY MANUFACTURER

## TAR RIVER IMPLEMENTS

BALER—MINI ROUND	32
BELT RAKE	25
BOX BLADES	82
CHAIN AND PASTURE HARROWS	53 , 55 – 56
CULTIPACKER	80
CONVENTIONAL DRILL (CROP-SEEDER)	44 – 45
CRIMPER	54
DISC HARROWS	79
DISC HARROW WITH SEEDER	52
DISC MOWERS	6 – 7
DITCH BANK MOWERS	62
DRILL—NO TILL	46 – 47
DRUM MOWERS	14
FINISHING MOWERS	57
FLAIL MOWERS	58
HAY TEDDER	18 – 19
HAY RAKE (POWER RAKE)	29
LAND LEVELER	83
LANDSCAPE RAKES	77
POST HOLE DIGGER	88
REAR BLADES	78
ROTARY CUTTERS	71 – 72
ROTARY RAKES	22 , 24
ROTARY TILLERS	
SUB-COMPACT (DLT SERIES)	38
COMPACT (TXG SERIES)	39
MEDIUM-DUTY (YCT SERIES)	40
MEDIUM-DUTY REVERSE ROTATION	41
HEAVY DUTY (RXT SERIES)	42
MULTI-SPEED GEARBOX (CXT)	43
SHANK CULTIVATOR	81
SPREADERS	
3 POINT	73
PULL-TYPE	74
COMPACT SIDE SHOT	75
PENDULAR	76
TRACTOR TOOLS	87 – 89
WOOD CHIPPERS	84 – 85

## ORSI

DITCH BANK	60 – 61
FLAIL MOWERS	59
HYDRAULIC BOOM MOWERS	
HEDGE	63
CUT REVERS	64
RIVER COMPACT	65
RIVER COMPACT PLUS	66
PERFORMANCE	67
PERFORMANCE PARALLELOGRAM	68
PERFORMANCE PARALLELOGRAM VISUAL	69
COMPARISON CHART	70





# ATTACHMENTS TAR RIVER

ADAPTER BRACKETS	114
BALE GRABBERS	96
BALE SPEARS	95
BALE UNWINDER	96
BRUSH CUTTERS (SKID LOADER)	
HEAVY DUTY	108
SERIOUS DUTY	109
BUCKETS	
BEAST SERIES	97
COMPACT UTILITY	97
LONG BOTTOM	99
LOW PROFILE	98
ROCK BUCKET	99
SERIOUS DUTY	98
GRAPPLES	
UTILITY ROOT GRAPPLES	101
COMMERCIAL ROOT GRAPPLES	102
CLAW GRAPPLES	103 – 104
ROCK GRAPPLE	100
FORK GRAPPLE	105
GRAPPLE BUCKET	105
LAND PLANE	107
MANURE FORKS	115
MINI SKID STEER ATTACHMENTS	116 – 117
PALLET FORKS	
SUB-COMPACT	92 – 93
COMPACT	92 – 93
MEDIUM DUTY	92 – 93
HEAVY DUTY	92 – 93
HYDRAULIC	94
WALK-THRU	94
STUMP BUCKETS & GRAPPLES	110 – 111
TRAILER MOVER	115
VIBRATORY POST DRIVER	106
QUICK-ATTACH PLATES	114
SNOW REMOVAL	112 – 113
TOOTH BARS	114



<b>DELTA HARROWS</b>	CHAIN HARROWS	53
	<hr/>	
<b>ECONO-WRAP</b>	SINGLE BALE WRAPPERS	
	STATIONARY	33
	SELF-LOADING	34 – 35
<hr/>		
<b>ENOROSI</b>	BALE WRAPPER (SELF-LOADING )	36
	DISC MOWER	8 – 9
	DISC MOWER WITH CONDITIONER	10 – 11
	MOWER CONDITIONERS	12 – 13
	SICKLEBAR MOWER	15
	HAY TEDDERS	16 – 17
	HAY RAKES	
	CARTED WHEEL RAKE	27
	BAT RAKE	28
	MAXIMUS RAKE	30
	EASY RAKE	31
	THREE POINT WHEEL RAKE	26
	TEDDER RAKE	23
ROTARY RAKE	20 – 21	
<hr/>		
<b>GREENSCAPE</b>	CONSERVATION SEEDER	50 – 51
	FOOD PLOTTER (NO-TILL DRILL)	48 – 49
	LIFT-SAFE IMPLEMENT HANDLER	118
<hr/>		
<b>KEMCO</b>	INLINE BALE WRAPPER	37



# Tar River

Available in 2 popular sizes, the Tar River side-mounted Disc Mower is built strong to stand up to years of rough conditions, giving you an excellent, quality cut. The reinforced A-frame made of heavy square tubing with Category II & III three-point hitch and the durable compensation spring ensure stability and durability during work.

The V-Belt and Shear-Hub systems protect the cutter-bar in the case of hitting obstacles. The break-away system provides additional protection to the cutter-bar by allowing it to pivot backwards when it encounters an obstruction. Simply back the tractor up and the break-away bar and mower will reset into the working position.

The cutter-bar is designed for quick and easy replacement of each of the individual cutting units, which eliminates the need to take apart the entire cutter-bar for most repairs.

Models available: 5 and 6 disc configurations.



### Standard Equipment:

- ◇ PTO Shaft 460 Nm
- ◇ Heavy Cutter bar with SAFETY DEVICE SYSTEM
- ◇ Protective Barriers made of a Bent Pipe Profile
- ◇ Protective Apron—reinforced with a rubber collar
- ◇ Quick Blade Change System
- ◇ Spring-based relief system
- ◇ Adjustable lower hitch pins
- ◇ Break-Away System

# Disc Mowers



## MOWER FEATURES

**LIFTABLE FRONT COVER + PROTECTIVE APRON**  
Easy access to the cutter bar to replace knives or a damaged bearing assembly.

**HYDRAULIC CYLINDER**  
Facilitates maneuvering and transport of the machine.

**BREAK-AWAY BAR**  
Protects the mower from damage.

**SPRING RELIEF SYSTEM**  
Relieves the pressure of the cutter bar on the ground, increasing its life span:

- ◇ Increases the range of terrain following ability
- ◇ Infinite ground pressure adjustment
- ◇ 0" - 8" range of terrain following



Quick Blade Change System

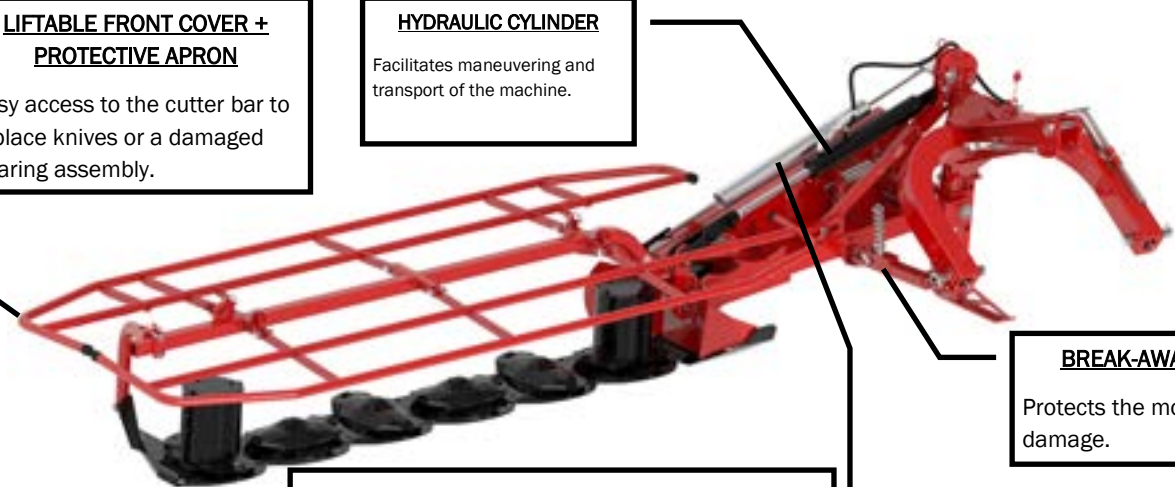

## CUTTING BAR WITH SAFETY SHEAR-HUB

Shear Hub Protection for Heavy Cutter bar

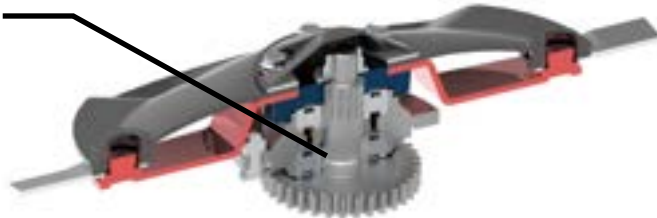

Model	# of Discs	Blades per Disc	Working Width	HP	Weight (lbs.)	List Price
DCM2083	5	2	6' 11"	30	1,096	\$9,480
DCM2098	6	2	8' 2"	45	1,162	\$10,280

# DISC MOWERS



Available in 5 popular sizes, the Enorossi side-mounted Disc Mower is built strong to stand up to years of rough mowing conditions, giving you an excellent quality cut. The heavy duty A-frame with Category 1 & 2 three-point hitch and the strong compensation spring ensure stability and durability.

The V-Belt and Shear-Hub systems protect the cutter-bar in the case of obstacles. The break-away system provides additional protection to the cutter-bar by allowing it to pivot backwards when it encounters an obstruction. Simply back the tractor up and the break-away bar and mower will reset into the working position.

The cutter-bar is designed for quick and easy replacement of each of the individual cutting units, eliminating the need to take apart the entire cutter-bar for most repairs.

Models available: 4, 5, 6, 7, and 8 disc configurations; 3-blade discs available on 4, 6 and 8 disc models.



Disc conveyor bolted on top of guard support to avoid wrapping problems



Anti-wrapping support for heavy grass



Moves 90° for transport - will cut at 35° up or down for hills, banks, terraces, etc.



**Specifications:**

- ◇ “Sneak-A-Peek” belt tension viewer for less down time
- ◇ Compensation spring “break-away” system
- ◇ Heavy Duty shield PTO shaft with overrunning clutch
- ◇ Hydraulic cylinder lift mechanism
- ◇ High blade tip speed for smooth, fast cutting efficiency



Easy changing hubs with 4-bolt disc cutting unit



Easily adjust belt tension without taking off outer cover



Heavy Duty A-Frame



Individual Shear-hub System on cutter bar



3 Blade discs available for 4, 6 and 8 disc models

Model	# of Discs	Blades Per Disc	Working Width	Lift	HP	PTO	Weight (lbs.)	Ship Weight (lbs.)	List Price
DM4	4	2	5'5"	Hydraulic	35	540 RPM	925	982	\$9,590
DM4 3C	4	3	5'5"	Hydraulic	35	540 RPM	931	986	\$9,730
DM5	5	2	6'7"	Hydraulic	40	540 RPM	1,015	1,070	\$10,265
DM6	6	2	8'	Hydraulic	50	540 RPM	1,103	1,158	\$10,940
DM6 3C	6	3	8'	Hydraulic	50	540 RPM	1,109	1,164	\$11,190
DM7	7	2	9'2"	Hydraulic	60	540 RPM	1,413	1,488	\$14,250
DM8	8	2	10'5"	Hydraulic	70	540 RPM	1,523	1,698	\$15,250
DM8 3C	8	3	10'5"	Hydraulic	70	540 RPM	1,532	1,707	\$15,550

# DISC MOWER



The DM ROLL series offers the rubber roller conditioner to facilitate the drying of the grass. Its agile use makes it suitable for quick and safe work.

Offered in two sizes to meet every farm's need.

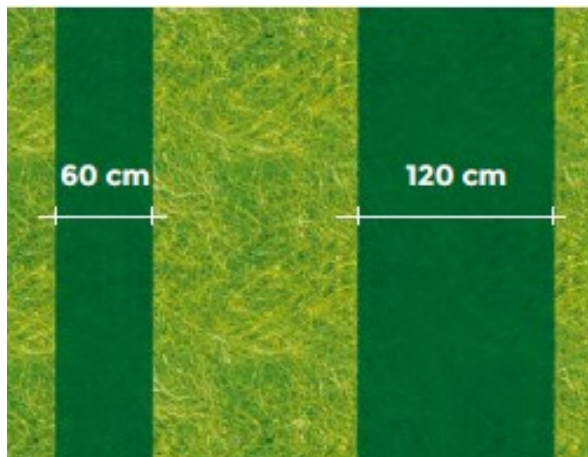

### Swath Adjustment Deflectors

The DMC ROLL Mowers have two rear reflectors that adjust the swath width which can be minimum of 60 cm (2 ft.) or maximum of 120 cm (4 ft.)



Rubber roller conditioner (standard).

# WITH CONDITIONER

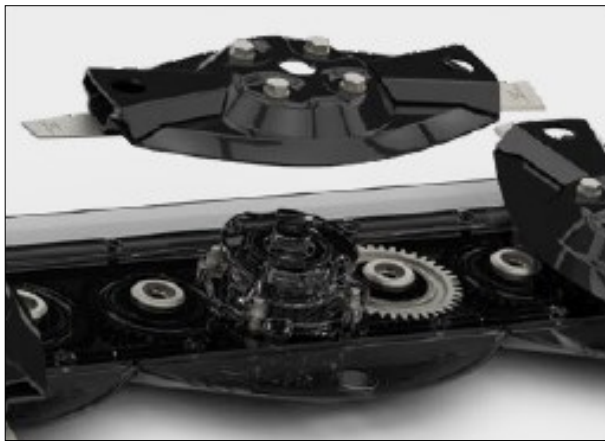

### Special Disc for Conditioner

The disc is more robust with a specific reinforcement that allows the launch of the product inside the ROLL rollers helping the work and therefore the forward speed.



### Gear Transmission

The two rubber rollers are gear driven to provide continuous synchronization in the event of uneven flow of high-volume grasses.

Model	# of Discs	Blades Per Disc	Working Width	Lift	HP	PTO	Weight (lbs.)	Ship Weight (lbs.)	List Price
DMC 5 ROLL	5	2	7 ft.	Hyd.	80-90	540 rpm	1,760	2,030	\$19,450
DMC 6 3C ROLL	6	3	8 ft.	Hyd.	90-100	540 rpm	1,910	2,160	\$21,750

# TREX MOWER



A side drawbar is the main feature characterizing our pull-type Disc Mowers with Conditioner series DMC-TREX 290 – 320. The drawbar can be hydraulically shifted and the block valve ensures a secure locking system. It is possible to choose between models without conditioner, FLAX models with blades conditioner and ROLL models with roller conditioner. A perfect cutting quality is assured by the Enocut cutting bar system.

Standard tires 340/55-16 12PR and second wide angle PTO Drive shaft.



High Quality Cutting Bar with 2 Year Limited Warranty

### Specifications:

- ◇ Easy changing hubs with 4-bolt disc cutting unit
- ◇ Individual Shear Hub system on cutter bar
- ◇ Heavy Duty shield PTO shaft with overrunning clutch
- ◇ Hydraulic cylinder lift mechanism
- ◇ High blade tip speed for smooth, efficient, and fast cutting
- ◇ Adjustable Swath Diverter



Optional Wearproof Skids Available



Working Position

# CONDITIONER



Steel FLAX Tine Conditioner



Double Rubber Roller Condition



Model	# of Discs	Working width	Conditioner Type	HP	Weight (lbs.)	List Price
<b>RUBBER ROLLER CONDITIONER</b>						
TREX250-ROLL	6	96"	Roller	45-85	3,634	\$30,605
TREX290-ROLL	7	114"	Roller	50-85	3,970	Call for Pricing
TREX320-ROLL	8	126"	Roller	55-85	4,300	Call for Pricing
<b>FLAX TINE CONDITIONER</b>						
TREX250-FLAX	6	96"	Flax Tine	45-85	3,484	\$29,870
TREX290-FLAX	7	114"	Flax Tine	50-85	3,815	\$35,275
TREX320-FLAX	8	126'	Flax Tine	55-85	4,150	\$36,858

Prices and specifications subject to change without notice. Check discounts & availability before quoting.  
 Product Designs May Differ Slightly Than What Appears in the Photographs.

# DRUM MOWERS



Make Sure to Check Tractor Weight!

Tar River Implements' Drum Mowers have very few moving parts, are low maintenance and have a heavy built A-frame. The Tar River Drum Mower is a great economic alternative to the Disc and Sickle bar mowers while still giving a good cut. The BDR Series Drum Mower can mow at high speeds and offers reliable mowing in all conditions, easily cutting through tall and thick grasses. Available in 4 popular sizes, Tar River Implements has a perfect fit for your small hay operation.

### Drum Mower Benefits:

- ◇ Mow at High Speeds
- ◇ No Hydraulics Necessary
- ◇ Few Moving Parts & Easy Maintenance
- ◇ Great Alternative to Disc & Sickle bar Mowers for Small Hay Producers
- ◇ Easily Cuts Through Tall and Thick Grass
- ◇ Designed for Reliable Mowing in All Conditions

### BDR Series Drum Mower Features:

- ◇ Heavy Duty A-frame
- ◇ 3 Blades per Drum (2 on the BDR-135 & 4 on BDR-210H)
- ◇ Compensation Spring "Break-Away" System
- ◇ High Blade Tip Speed for Smooth, Fast Cutting Efficiency
- ◇ V-Belt Drive
- ◇ Internal Overrunning Clutch
- ◇ Easy & Quick Blade Change

Model	# of Drums	Blades Per Drum	Category Hitch	Working Width	Min. Recommended Tractor Weight	Lift	Min HP	PTO	Weight (lbs.)	List Price
BDR-135	2	2	Cat. 1	4'5"	2,100 lbs.	Manual	20	540 RPM	661	\$3,840
BDR-165	2	3	Cat. 1 & 2	5'5"	2,600 lbs.	Manual	28	540 RPM	794	\$3,940
BDR-185	2	3	Cat. 1 & 2	6'1"	3,900 lbs.	Manual	35	540 RPM	893	\$4,700
BDR-210H	2	4	Cat. 2 & 3	6'9"	6,500 lbs.	Hyd.	65	540 RPM	1,240	\$6,975
BDR-A80	Hydraulic Lift Kit for BDR-165/185									\$570

# SICKLE BAR MOWERS



These double action Sickle Bar Mowers with an adjustable 3 point hitch ensure a sharp clean cut on any type of grass. The safety breakaway bar helps protect the cutter from obstructions in the field.



Safety breakaway bar

### Specifications:

- ◇ Three Point Hitch Cat.1 & 2
- ◇ Double Action cutter bar
- ◇ Heavy duty shielded PTO shaft
- ◇ High quality powder-coat paint
- ◇ Cuts at 90° up and 70° down
- ◇ Safety release
- ◇ Ideal for hay or ditch bank mowing
- ◇ Extra cutting blade included

Model	Working Width	Cutting Action	HP	Lift Type	Weight (lbs.)	Ship Weight (lbs.)	List Price
BFT 150	5'	Double	12 - 50	Select Kit	441	491	\$5,375+ Lift Kit
BFS 180	6'	Double	20 - 75	Select Kit	575	625	\$6,070+ Lift Kit
BFS 210	7'	Double	30 - 75	Select Kit	634	684	\$6,200+ Lift Kit
BFS 240H	8'	Double	35 - 75	Hydraulic	673	723	\$7,895
BFS 270H	9'	Double	35 - 75	Hydraulic	711	751	\$8,020

### MANUAL AND HYDRAULIC LIFT KITS

R0180-31500	Manual Lift Kit for BFT 150	\$385
R0180-31344	Hydraulic Lift Kit for BFT 150	\$605
R0173-10005	Manual Lift Kit for BFS 180/210	\$390
R0180-31301	Hydraulic Lift Kit for BFS 180/210	\$625
Sickle Bar Mowers are packaged 2 per crate (additional cost if purchased individually)		\$100 net

Prices and specifications subject to change without notice. Check discounts & availability before quoting.  
Product Designs May Differ Slightly Than What Appears in the Photographs.

# HAY TEDDERS



55 MPH Transport Tires  
on 19' G4V 570



## VORTEX TEDDER

The Enorossi Vortex Hay Tedder comes in the 17', 19', 24', and 32' working widths. All units come standard with hydraulic lift, high-floatation 16" balloon tires, and fender hubs on the inside tires, Universal-Joint rotor style and a heavy 8"x4" rectangular-tube frame. The 19', 24', and 32' tedders come standard with hydraulic tilt.

The newest additions to the lineup are the Professional G6V 740PRO and G8V 980PRO. A 6 and 8 basket tedder with heavy transport frame allowing it to quickly fold up and speed from field to field.



U-Joint Engagement on Rotors



Inside Wheel Fenders Standard

### Specifications

G4V 520 & G4V 570	G6V 740	G6V PRO	G8V PRO
<ul style="list-style-type: none"> <li>◇ 17' &amp; 19' Working Widths</li> <li>◇ 3pt Hitch on G4V5203PH</li> <li>◇ Overrunning Ratchet Clutch PTO</li> <li>◇ High Floatation Balloon Tires - 16x650/8</li> <li>◇ High Speed transport tires on G4V 570</li> <li>◇ U-Joint Engagement On Wing Rotors</li> <li>◇ Heavy Built, Rectangular Tube-Frame</li> <li>◇ Wheel Fenders On Inside Tires</li> <li>◇ Standard Hydraulic Lift</li> <li>◇ Standard Hydraulic Tilt On G4V 570 Model (manual crank tilt on 17')</li> </ul>	<ul style="list-style-type: none"> <li>◇ 24' Working Width</li> <li>◇ Overrunning Ratchet Clutch PTO</li> <li>◇ 4 High Floatation Balloon Tires - 16x650/8 on Outside Rotors</li> <li>◇ 2 Tandem Axles on Central Rotors</li> <li>◇ U-Joint Engagement On Wing Rotors</li> <li>◇ Heavy Built, Rectangular-Tube Frame</li> <li>◇ Wheel Fenders On Inside Tires</li> <li>◇ Hydraulic Tilt &amp; Lift Standard</li> </ul>	<ul style="list-style-type: none"> <li>◇ 24' Working width</li> <li>◇ 6 High Floatation Balloon Tires – 16x650/8</li> <li>◇ 2 High Speed transport tires – 18x850/8</li> <li>◇ Hydraulic Tilt &amp; Lift Standard</li> <li>◇ U-Joint Engagement On Wing Rotors</li> <li>◇ Heavy Built, Rectangular-Tube Frame</li> <li>◇ Wheel Fenders On Inside Tires</li> <li>◇ Mechanical adjustment of the working angle</li> <li>◇ Overrunning Ratchet Clutch PTO</li> </ul>	<ul style="list-style-type: none"> <li>◇ 32' working width</li> <li>◇ 8 High Floatation Balloon Tires – 16x650/8</li> <li>◇ 2 High Speed transport tires – 350/50 R16</li> <li>◇ Hydraulic Tilt &amp; Lift Standard</li> <li>◇ U-Joint Engagement On Wing Rotors</li> <li>◇ Heavy Built, Rectangular-Tube Frame</li> <li>◇ Wheel Fenders On Inside Tires</li> <li>◇ Mechanical adjustment of the working angle</li> <li>◇ Overrunning Ratchet Clutch PTO</li> </ul>





# G6V 740PRO



# G6V 740PTH



# G6V 740PRO

Model	Working Width	Lift Standard	Tilt	Rotors	Min HP	Tine Arms	Tires	Weight (lbs.)	List Price
G4V 520 3PH	17'	Hydraulic	Mechanical (Hyd. Option)	4	50	24	(4) 16x650/8	1,322	<b>\$10,750</b>
G4V 520PTH	17'	Hydraulic	Mechanical (Hyd. Option)	4	50	24	(4) 16x650/8	1,080	<b>\$9,125</b>
G4V 570PTH	19'	Hydraulic	Hydraulic	4	50	24	(2) 16x650/8 (2) 18x850/8	1,157	<b>\$10,650</b>
G6V 740PTH	24'	Hydraulic	Hydraulic	6	50	36	(4) 16x650/8 (4) 18x850/8	2,160	<b>\$14,750</b>
G6V 740PRO	24'	Hydraulic	Hydraulic	6	50	36	(4) 16x650/8 (4) 18x850/8	3,938	<b>\$27,385</b>
G8V 980PRO	32'	Hydraulic	Hydraulic	8	50	48	(8) 16x650/8 (2) 350/50 R16	4,190	<b>\$31,750</b>
<b>OPTIONAL EQUIPMENT</b>									
R0180-34069	Hydraulic Tilt Option for G4V 520PTH								<b>\$970</b>

Prices and specifications subject to change without notice. Check discounts & availability before quoting.  
Product Designs May Differ Slightly Than What Appears in the Photographs.



# TAR RIVER



## PRZ-5500

The Tar River Tedder is built heavy in all the right places, this machine is designed to withstand the rigors of high-volume hay production.

The PRZ-3100 is a 10' tedder with 4"x8" tubing. This unit is a pull-type with a manual tilt and flat-bar tine arms. On the 18' PRZ-5500, large 18" tires give the tedder great floatation across uneven terrain. Adjustable angling allow boundary tedding. Thick-walled tubular tine arms hold up long after the flat bar style ones would have bent. Hydraulic tilt and fold come standard.



Thick-Walled Tubular Tine Arms

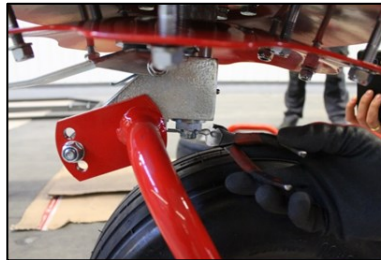

Adjustable Angle and Tilt



Hyd. Tilt and Fold



# HAY TEDDERS



## PRZ-3100

### Specifications:

#### PRZ-3100

- ◇ 10' Working Widths
- ◇ Overrunning Ratchet Clutch PTO
- ◇ High Flotation Tires
- ◇ Heavy Built, Rectangular Tube-Frame
- ◇ Packaged 2 per crate
- ◇ Manual Tilt

#### PRZ-5500 (includes all features of PRZ-3100 plus)

- ◇ 18' Working Width
- ◇ Wheel Fenders on Inside Tires
- ◇ Road Transport tires
- ◇ Hydraulic Lift
- ◇ Can be angled for "close to" fence tedding
- ◇ Hydraulic Tilt
- ◇ Heavy-walled tubular arms
- ◇ Integrated Locking collars and hex shaft drive units
- ◇ Double plated rotor supports
- ◇ Adjustable Wheel Yokes—Swivel and Tilt
- ◇ One Hydraulic Remote needed
- ◇ Overrunning Ratchet Clutch PTO

Model	Working Width	Lift	Tilt	Rotor Style	Rotors/ Arms	Min HP	Tires	Weight (lbs.)	List Price
PRZ-3100	10'	N/A	Mech.	N/A	2 / 12	15	(2) 15x600/6	507	\$3,830
PRZ-5500	18'1"	Hyd.	Hyd.	U-Joint	4 / 24	35	(4)18x8.5/8	1,594	\$10,950
10' tedders are packaged 2 per crate (additional cost if purchased individually)									\$100 net

Prices and specifications subject to change without notice. Check discounts & availability before quoting.  
Product Designs May Differ Slightly Than What Appears in the Photographs.



# ROTARY

## SINGLE AND DOUBLE ROTOR CONFIGURATIONS



Enorossi's Single & Double Rotary Rakes come standard with pneumatic pivoting wheels and heavy, tubular tine arms that are removable for transport. The RR-350 has 11 rotor arms that sweep cleanly all hay types in any condition.

The ENODUO 780 is a center delivery double rotary rake with an adjustable working width from 23' to 25'6". It comes with four wheels per rotor for excellent stability on uneven ground and is semi-mounted with rear steering wheels for maximum maneuverability. The gentle raking action ensures high nutrient levels remain on the crop and in the bale - not in the field.



Tandem Wheel Axles



Heavy Duty, Sealed Oil Bath G-box



Transport Position



### Specifications:

- ◇ Extra heavy duty frame and components
- ◇ Hydraulic transport lift standard
- ◇ Heavy-duty, sealed oil bath gearbox
- ◇ Large, high floatation tire
- ◇ Standard tandem axle
- ◇ Removable tine arms
- ◇ Great economic option for those smaller-range tractors and hilly conditions
- ◇ 20" Ground Clearance Hydraulic Lift for transport

# RAKES



**TRACER 7802**

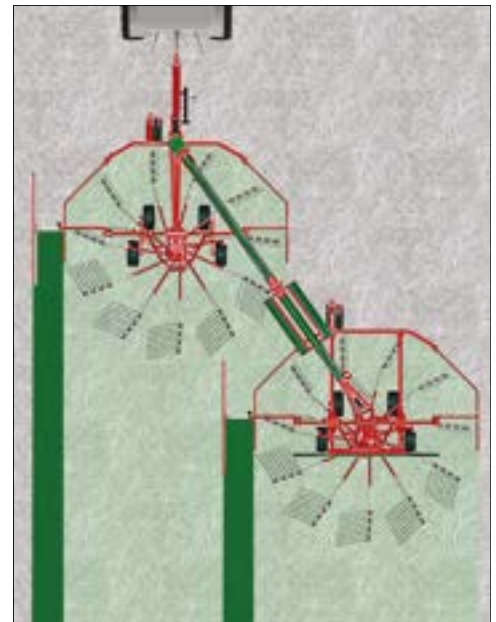

**ENODUO 780**



Model	Working Width	Lift	Windrow	Min HP	Tine Arms	Tines	Weight (lbs.)	Ship Weight (lbs.)	List Price
RR350	11'6"	3 Pt	Side	30	9	27	827	867	\$6,975
RR420 EVO PT	13' 9"	Pull-type Hydraulic	Side	30	11	44	1,370	1,470	\$11,125
ENODUO 780	23' - 25'6"	Semi-Mount Hydraulic	Center	70	22	88	3,950	4,400	\$33,825
TRACER 7802	25'6"	Semi-Mount Hydraulic	Side	70	22	88	4,080	4,400	\$39,750

Prices and specifications subject to change without notice. Check discounts & availability before quoting.  
Product Designs May Differ Slightly Than What Appears in the Photographs.



# ROTARY RAKE

Tar River Implement's Single Rotary Rake comes standard with hydraulic height adjustment and heavy tubular tine arms that are foldable for transport. The ZRG-420 has 11 rotor arms that cleanly sweep all hay types in any condition. Wide angle constant velocity PTO shaft come standard. Replaceable wheel hubs ensure transportation is not a problem. The gentle raking action ensures high nutrient Leaves remain on the crop in the bale, not in the field.

The ZRG-360 is a 3-point version with a 9 arm gearbox for use in tighter areas where a pull-type will not allow you to reach all



## ZGR-420



### Tandem Suspension

Allows the rotor to float over any terrain while following ground contour perfectly. Replaceable wheel hubs on ZGR-420



### Foldable Tine Arms

Thick-Walled tubular tine arms, 4 or 6 of which fold for transport. Each arm is equipped with heavy tines.



## ZGR-360

### Specifications:

- ◇ 11'10" and 13' 9" working width
- ◇ 15x6.0-6 Tires on ZGR-360
- ◇ 18.850-8 Tires w/ transport hubs on ZGR-420
- ◇ Hydraulic Transport Lift on ZGR-420
- ◇ Thick-walled, tubular tine arms

- ◇ Heavy-Duty, sealed oil bath gearbox
- ◇ Strong & Heavy Frame to prevent bouncing
- ◇ Standard Tandem Axle
- ◇ Foldable Tine Arms for Transport
- ◇ Ratchet Clutch protection
- ◇ Wide Angle (CV Joint) on ZGR-420

Model	Working Width	Lift	Hitch	Min HP	Tine Arms	Tines	Weight (lbs.)	List Price
ZGR-360	11'10"	Hyd.	3 Pt.	30	9 (4 folding)	27	1,257	\$7,350
ZGR-420	13' 9"	Hyd.	Pull Type	30	11 (6 folding)	44	1,489	\$9,850

# TEDDER RAKE



Enorossi's DR420 –2 Rotor Tedder Rake is ideal for medium-sized and large farms requiring a multifunctional machine. It's the ideal solution for farmers who want to obtain both central and lateral windrows depending on the quantity of the harvested material. It can perform many different tedding and raking functions always with optimal processing of your high-quality forage. Standard equipped with cardan shaft, protections, inverter and twin wheels. The high working speed of almost 10 mph allows outstanding performances.

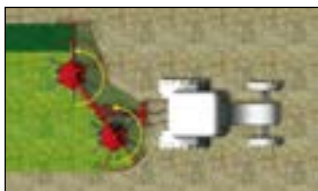

Lateral Windrow

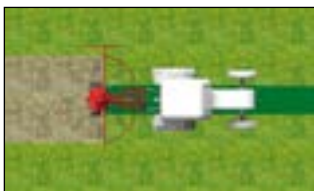

Tedding



Spheroidal cast iron cam and steel rollers.



Twin pivoting wheels

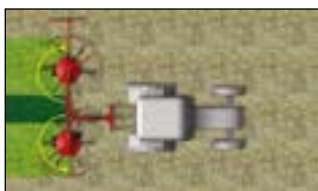

Center Windrow

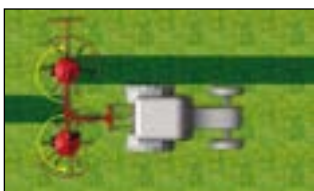

Windrow Turner



Position change from Rake to Tedder

Model	Raking-Width	Tedding-Width	Min HP	Tine Arms	Tines	Weight (lbs.)	List Price
DR420	12.1/13.8 ft.	11.1/11.8 ft.	35	12+6	24+18	1104	<b>\$11,950</b>

Prices and specifications subject to change without notice. Check discounts & availability before quoting.  
Product Designs May Differ Slightly Than What Appears in the Photographs.

# R-Rake



The RR-248 was designed with the needs of the small hay farmer in mind. Ted and Rake with a single machine.

With a 72" working width, this rotary rake is capable of delivering an excellent quality of performance while still being compact enough to be used with a 20 HP tractor.

The high-quality but affordable materials make this rake durable and a great choice for budget farms.

With the RR-248's combination of performance, durability, and affordability, it is the next-best-thing for



High Flotation Bearing  
Tires



Simple Cam System



Model	Working Width	Tine Arms	Tines	Weight (lbs.)	List Price
RR-248	72"	6	12	364	\$2,595



# BELT RAKE



Two machines in one - rake and ted with the Tar River Implements Belt Rake! With its compact design and versatile functionality, the Belt Rake is an ideal hay tool for the small to medium sized hay producer. Great durability and low maintenance as well as simplicity of use are just a few benefits for this tedder-rake combination Belt Rake.

The D150-3 is a low profile design that can operate with any HP tractor. Simple and easy to use with very low maintenance. The 3 tines per row make clean a sweep of your pasture. Fast adjustments allow one to go from tedding to raking in a breeze.

D180-4 comes standard with 4 double tines per row and all the features of the D150-3. This extra set of tines is helpful in heavier hay crop conditions.



## Specifications:

- ◇ Heavy square tubing construction
- ◇ Heavy duty belts for long life
- ◇ Rear Height adjustment wheels
- ◇ Front Pivot wheel

Model	Working Width	# of Belts	Tines x Crossbeam	Weight (lbs.)	List Price
D150-3	71"	2	3	408	\$3,990
D180-4	83"	2	4	485	\$4,455

# 3 POINT WHEEL RAKE

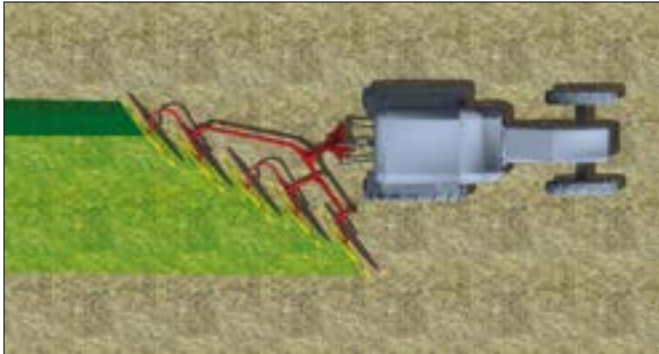

An easy and efficient hay rake suitable for any type of forage. The spring system of the tool holder allows raking wheels to adapt to any type of ground with the correct pressure and without affecting the forage quality. Independent and interchangeable raking wheels mount on tapered roller bearings. Teeth made of flexible steel.



- Specifications:**
- ◇ Heavy tubular frame with strategically placed bracing
  - ◇ Molded steel hubs with tapered roller bearings
  - ◇ 7 mm heavy spring steel teeth
  - ◇ High quality powder-coat paint

RP3C has a specifically designed A-frame for smaller sub-compact tractors.

Perfect tool for windrow turning or raking pine straw.

Model	# Wheels	Teeth per Wheel	Wheel Dia.	Work Width	Weight (lbs.)	List Price
RP3C	3	40	55"	6'5" - 7'11"	199	\$1,195
RP4	4	40	55"	8'6" - 9'6"	393	\$1,725
RP5	5	40	55"	11' 2" - 12'2"	464	\$2,075
Rakes are 2 per crate – Both same size (additional cost if purchased individually)						\$100 net

# CARTED WHEEL RAKE



**Unit Shown w/ Optional Center Kicker Wheel**

The Enorossi Carted Wheel Rake, with its 15" tires and heavy 6.9 mm teeth, gives you the ability to cruise at high ground speeds with less worries about teeth breakage. Tapered roller bearings keep the wheels running smoothly and easily with minimum maintenance. Frame construction is thick-walled square tubing to give years of reliable service.

### Specifications:

- ◇ Heavy square tubing construction on Rake Cart
- ◇ 205/70-15 tires standard
- ◇ Heavy tubular frame with strategically placed bracing
- ◇ Molded steel hubs with tapered roller bearings
- ◇ Optional Kicker wheel available
- ◇ 6.9 mm heavy spring steel teeth
- ◇ Double-action hydraulic cylinder
- ◇ Compact design
- ◇ High quality powder-coat paint

Model	# of Wheels	Teeth per Wheel	Wheel Dia.	Work Width	Transport Width	Weight (lbs.)	Ship Weight (lbs.)	List Price
CADDY 8	8	40	55"	17' 7'	8' 2"	1,324	1,409	\$6,475
CADDY 10	10	40	55"	21'	8' 2"	1,470	1,555	\$7,175
CADDY 12	12	40	55"	24' 3"	8' 2"	1,624	1,709	\$8,175

### OPTIONAL EQUIPMENT

R0180-31191	Kicker wheel attachment	\$845
R0180-31090	Select-a-valve (to raise one side only)	\$145

# BAT RAKE



## HIGH CLEARANCE CARTED RAKE



60" Biggy Rake Wheels  
with 7.5 mm Tines Are  
Standard!

Raking wheels sit at a  
7° angle to create fluffier  
windrows and leave less  
hay in your fields!

**32" Ground Clearance**

Enorossi's Bat Rake is the new standard for Hay Rake Caddies. Available in 8, 10 and 12 wheel sizes, the Bat Rake comes in a Single Wheel configuration allowing each individual raking wheel to follow all types of ground contours. Equipped with 60" diameter raking wheels and 7.5 mm tines, the Bat Rake's raking wheels are arguably the best raking wheel on the market today. The heavy spring tines, provide for excellent wear and strong resistance to breakage. The heavy-built frame and high profile of the Bat Rake give a full 32" of ground clearance allowing it to rake in all types of ground contours in heavy hay conditions.

### Specifications:

- ◇ Independent rake wheel arms to follow all ground contours
- ◇ High Clearance - 32" of Ground Clearance
- ◇ Perfect for heavy hay
- ◇ Easy windrow width adjustment
- ◇ Heavy built and low maintenance
- ◇ 60" raking wheels with 7.5 mm tines
- ◇ Heavy built and low maintenance
- ◇ 205/70-15 tires standard
- ◇ Heavy tubular frame with strategically placed bracing
- ◇ Molded steel hubs with tapered roller bearings
- ◇ Double-action hydraulic cylinder
- ◇ Compact design

Model	# Wheels	Teeth per Wheel	Wheel Dia.	Max Work Width	Teeth Diameter	Weight (lbs.)	Ship Weight (lbs.)	List Price
BAT 8-H	8	40	60"	18'5"	7.5 mm	1,445	1,595	\$9,475
BAT 10-H	10	40	60"	21'8"	7.5 mm	1,644	1,794	\$10,275
BAT 12-H	12	40	60"	24'3"	7.5 mm	1,886	2,036	\$11,285

### OPTIONAL EQUIPMENT

R0180-32136	Kicker wheel attachment	\$890
R0180-32659	Wind Guard for Rake Wheels (Sold Individually)	\$54

# POWER RAKE



In partnership with Enorossi, Tar River Implements introduces the Power Rake.

This new high-clearance rake is available in 8, 10, and 12 wheel sizes.

Equipped with 60" diameter raking wheels and 7.5 mm tines, the Power Rake's raking wheels are the best raking wheel on the market today. The heavy spring tines, provide for excellent wear and strong resistance to breakage. The heavy-built frame and high profile of the Power Rake give a full 32" of ground clearance allowing it to rake in all types of ground contours in heavy hay conditions.



**Shown w/ Optional Wind Guards & Kicker Wheels**

## Specifications:

- ◇ Independent rake wheel arms to follow all ground contours
- ◇ High Clearance - 32" of Ground Clearance
- ◇ Perfect for heavy hay
- ◇ Easy windrow width adjustment
- ◇ Heavy built and low maintenance
- ◇ 60" raking wheels with 7.5 mm tines
- ◇ Heavy built and low maintenance
- ◇ 205/70-15 tires standard
- ◇ Heavy tubular frame with strategically placed bracing
- ◇ Molded steel hubs with tapered roller bearings
- ◇ Double-action hydraulic cylinder
- ◇ Compact design

Model	# Wheels	Teeth per Wheel	Wheel Dia.	Max Work Width	Teeth Diameter	Weight (lbs.)	Ship Weight (lbs.)	List Price
PR 8	8	40	60"	18' 11"	7.5 mm	1,766	1,916	\$9,475
PR 10	10	40	60"	21' 8"	7.5 mm	1,987	2,137	\$10,275
PR 12	12	40	60"	24' 3"	7.5 mm	2,318	2,466	\$11,285

## OPTIONAL EQUIPMENT

RO180-38089	Power Rake Kicker wheel attachment	\$1,640
-------------	------------------------------------	---------

Prices and specifications subject to change without notice. Check discounts & availability before quoting.  
Product Designs May Differ Slightly Than What Appears in the Photographs.

# MAXIMUS RAKE

## HIGH CAPACITY CARTED WHEEL RAKE



60" Biggy Rake Wheels  
with 7.5 mm Tines Are  
Standard!

**Shown w/ Optional Wind Guards & Kicker Wheels**

The MAXIMUS Rake has been designed to match the customer's high demands. It is available in 3 sizes; 12, 14, and 16 wheel configurations. All versions feature independent rake wheel arms using a unique double rod spring system to maintain constant pressure of the raking wheels to the ground. The heavy duty frame and wide tire spacing give great stability in heavy conditions.

### Specifications:

- ◇ Independent Rake Wheel Arms to Follow All Ground Contours
- ◇ Perfect for Heavy Hay
- ◇ Easy Windrow Width Adjustment
- ◇ 60" Raking Wheels with 7.5 mm Tines
- ◇ Heavy Duty and Low Maintenance
- ◇ Tandem Tires Standard
- ◇ Heavy Tubular Frame with Strategically Placed Bracing
- ◇ Molded Steel Hubs with Tapered Roller Bearings
- ◇ Optional 2 front/1 rear Kicker Wheel available

Model	# of Wheels	Teeth per Wheel	Wheel Dia.	Max Work Width	Teeth Diameter	Weight (lbs.)	List Price
M12	12	40	60"	24'	7.5 mm	3,064	\$17,550
M14	14	40	60"	27'	7.5 mm	3,306	\$18,325
M16	16	40	60"	30'	7.5 mm	3,748	\$20,425

### OPTIONAL EQUIPMENT

MAX-001	Kicker wheel attachment	\$1,950
RO180-32659	Wind Guard for Rake Wheels (Sold Individually)	\$54
RO180-35861	M14 to M16 wheel conversion kit	\$3,195
RO180-36131	M12 to M14 wheel conversion kit	\$1,340

# HIGH CAPACITY EASY RAKE



60" Biggy Rake Wheels with 7.5 mm Tines Are Standard!

**Shown w/ Optional Wind Guards**

The Enorossi High Capacity Easy Rake is both easy to assemble and easy to use. Assembly time is typically 1/2 that of other High Capacity Rakes.

The Easy Rake has been designed with a series of innovations that are unique to the market that improves operator productivity. The two sides are independent from one another allowing the machine to operate with a single side. Simple swath adjustment is obtained by a system of easy-to-use bushings.



## Specifications:

- ◇ Heavy square tubing construction
- ◇ 205/70-15 tires standard
- ◇ 4 3/4 Heavy tubular frame with strategically placed bracing
- ◇ Molded steel hubs with tapered roller bearings
- ◇ 7.5 mm diameter heavy spring steel teeth
- ◇ Compact design
- ◇ High quality powder-coat paint
- ◇ 40 teeth per wheel
- ◇ 60" Wheel diameter
- ◇ Optional Double Kicker wheel available

Model	# of Wheels	Work Width	# of Tires	Weight (lbs.)	List Price
ER 10	10	21' 5"	4	2,870	\$16,575
ER 12	12	24' 4"	4	3,046	\$17,395
ER 14	14	27' 4"	6	3,709	\$20,375
ER 16	16	31' 4"	8	5,180	\$29,995
ER 18SN	18	34' 3"	12	6,945	\$38,250
ER 20SN	20	37' 5"	12	7,385	\$39,675
ER 22SN	22	39' 8"	12	8,050	\$45,550

## OPTIONAL EQUIPMENT

R0180-32111	Kicker wheel attachment	\$1,925
R0180-32659	Wind Guard for Rake Wheels (Sold Individually)	\$54

Prices and specifications subject to change without notice. Check discounts & availability before quoting.  
Product Designs May Differ Slightly Than What Appears in the Photographs.

# MINI ROUND BALER



Perfect for the small farmer who wants to produce their own hay. It's low cost and a time saver. The affordable SRB-870 or SRB-870NW allows you to control when you bale, not others. The auto twine binding system alerts the operator, who simply pushes a button, to open the rear door hydraulically, thus dropping the bale.

The net wrapping system of the SRB-870NW works the same way except with even better weather resistance, and reduction of loss from heavy handling with net wrapping. The baler comes with a self-contained hydraulic pump. Only a connection to the tractors 12V battery is needed to operate the baler making it easy and mess free.



## SRB-870 Twine Baler

- ◇ 3 pt. Category 1 Hitch
- ◇ 18-30 HP
- ◇ Electronic Control Box
- ◇ Includes 1 Roll of 8500' Twine

## SRB-870NW Net Wrap Baler

- ◇ 3 pt. Category 1 Hitch
- ◇ 18-30 HP
- ◇ Electronic Control Box
- ◇ Includes a starter roll of net wrap (approx. 50 bales)



Model	Bales	Pickup	Tractor HP Min	Working Capacity	Weight (lbs.)	List Price
SRB-870	23" x 28"	2' 6"	18 HP	80-100 bales/hour	1,025	\$6,950
SRB-870NW	23" x 28"	2' 6"	18 HP	80-100 bales/hour	1,102	\$7,750

### REPLACEMENT TWINE/WRAP

TG0800	Replacement 8500' Twine	\$25 (Parts Discount)
SRBW006	Replacement 26" x 5000' Net Wrap Roll	\$125 (Parts Discount)



# STATIONARY BALE WRAPPER

**Econo-Wrap**



Bale Guides To Provide Even Placement of Film Wrap



Film Slicer At The End of Rotary Table Cuts Film After Bale Is Unloaded and New One Is Set Back On For Continuing Operation



Quality Components Such As The Hydraulic Motor & Bevel Gears Ensure Long Machine Life



Too much rain? Try wrapping your hay with the Econo-Wrap Single Bale Wrapper. The Econo-Wrap Bale Wrapper was designed with the average farmer in mind and is ideal for small-scale hay producers. This 3 Pt. Hitch Stationary model will wrap bales up to 4' x 5' round bales.

## Specifications:

- ◇ Wraps round bales up to 4'x5' (weighing up to 2,100 lbs.)
- ◇ Hooks up to 3 pt. Hitch and runs off of the auxiliary hydraulics
- ◇ When done wrapping, lift 3 pt. hitch to unload bale
- ◇ Unit is equipped with bale counter
- ◇ Approx. wrap time: 90 seconds



**EW-450**

Model	Transport	Film Size	Max. Bale Size	Max. Bale Weight	Min. HP	Weight (lbs.)	List Price
EW-450	3 Pt. Hitch	20" or 30"	4' x 5'	2,100 lbs.	40 HP	1,091	\$5,375
<b>OPTIONAL EQUIPMENT</b>							
EW-001A	Vertical Bale Positioner EW-450						\$580
EW35000	30" x 5000' Silage Wrap Replacement <i>(Parts Discount)</i>						\$125

Prices and specifications subject to change without notice. Check discounts & availability before quoting.  
Product Designs May Differ Slightly Than What Appears in the Photographs.

# SELF-LOADING



Upgrade your baling operation with the Econo-Wrap EW-1800TA, a streamlined wrapper designed for solo operators. With the ability to wrap bales up to 4' x 5', this fully automated machine requires only one button push to initiate the wrapping process.

Effortlessly fit the bale into the lifting arm cradle, press the button and watch as the EW-1800TA takes over—lifting the bale onto its turntable and beginning the automatic wrapping process. Enjoy the freedom to drive up to the next bale while the machine continues wrapping, dumping it only when fully finished.

The Econo-Wrap EW-1800TA is the perfect partner for your baling needs.



# BALE WRAPPER

**Econo-Wrap**



**Specifications:**

- ◇ Wraps round bales up to 4'x5' (weighing up to 2,425 lbs.)
- ◇ Fully automated electronic control allows user to select from 3 cycles (Automatic, Semi-Automatic or Manual)
- ◇ Side tip damper standard
- ◇ Unit is equipped with bale counter
- ◇ 3 film roll holders



Model	Transport	Film Size	Max. Bale Size	Max. Bale Weight	Min. HP	Weight (lbs.)	List Price
EW-1800TA	Trailer-Type	20" or 30"	4' x 5'	2,425lbs.	45 HP	4,520	\$26,515

**REPLACEMENT WRAP**

EW35000	30" x 5000' Silage Wrap Replacement ( <i>Parts Discount</i> )						\$125
---------	---------------------------------------------------------------	--	--	--	--	--	-------

Prices and specifications subject to change without notice. Check discounts & availability before quoting.  
 Product Designs May Differ Slightly Than What Appears in the Photographs.

# SELF-LOADING BALE WRAPPER

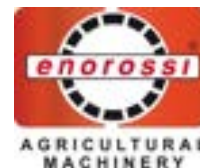

Enorossi's BW 100 EVO is a mounted satellite bale wrapper with self-loading device that allows you to perform different operations on the move. It is equipped with brake and vertical bale unloading kit standard.



Model	Transport	Film Size	Max. Bale Size	Max. Bale Weight	Min. HP	Weight (lbs.)	List Price
BW 100 EVO	3 pt. Hitch Cat. 2	20" or 30"	4' x 5'	2,200 lbs.	80 HP	1,880	\$21,450
<b>REPLACEMENT WRAP</b>							
EW35000	30" x 5000' Silage Wrap Replacement ( <i>Parts Discount</i> )						\$125

# INLINE BALE WRAPPER



Eliminate the rush of baling hay for threat of an oncoming storm. Reduce the amount of waste at feeding time, improve your hay harvest efficiency and reduce loss in harvest and storage. Accomplish all of this with the KEMCO Inline Bale Wrapper, the fastest wrapper on the market, which wraps up to 4 bales per minute. As fast as you put them up, they will be wrapped!



Model	# of Plastic Dispensers	Type of Bales	Wrapping Width	Remote Steering	Engine	Self-Propel Drive	Film Sensor	Hyd. Tailgate Lift	LED Lights	Weight (lbs.)	List Price
<b>MODEL 355</b>											
KEMCO 355 PRO 2	3	Round / Square	6'6" Round / 5'6" Square	Yes	20 HP	Dual Wheel	Std	Std	2	6,320	<i>Call for Pricing</i>

Prices and specifications subject to change without notice. Check discounts & availability before quoting. Product Designs May Differ Slightly Than What Appears in the Photographs.

# SIDE SHIFT ROTARY TILLER



Specifically designed and engineered for sub-compact tractors in the 15-25 Horsepower range, the Tar River DLT Series Rotary Tiller is built with 4 blades per flange and a sturdy #80 chain drive system to give you years of reliable service. The Slip-Clutch PTO protection comes standard.

Available in 42" and 50" working widths, the Tar River DLT Series Rotary Tiller is perfect for all your small-tractor tilling needs.

## DLT Series

\*Model Shown is DLT-S42



### Specifications for DLT Series:

- ◇ #80 Chain Drive Transmission
- ◇ 4 Blades Per Flange
- ◇ PTO with Slip-Clutch Protection
- ◇ Solid A-Frame
- ◇ Side-Shift Standard
- ◇ 4" Tilling Depth
- ◇ 3" Offset capability

Model	Working Width	Blades per flange	Drive	HP	Weight (lbs.)	Ship Weight (lbs.)	List Price
<b>SUB-COMPACT SERIES</b>							
DLT-S42	42"	4	#80 Chain	15 - 25	304	375	\$1,725
DLT-S50	50"	4	#80 Chain	15 - 25	348	429	\$1,835

# COMPACT ROTARY TILLER



Built to fit the needs of the compact tractor market, the Tar River TXG Series Rotary Tiller will work great at tilling up your small garden plots. It comes standard with a “gear-to-gear” drive system, 6 blades per flange and Slip-Clutch PTO protection.

Available in 41”, 48” and 59” working widths, the Tar River TXG Series Rotary Tiller is perfect for all your small-tractor tilling needs.

## TXG Series

\*Model Shown is TXG-060



### Specifications for TXG Series:

- ◇ Gear Drive Transmission
- ◇ 6 Blades Per Flange
- ◇ PTO with Slip Clutch
- ◇ Powder Coat Paint
- ◇ Solid A Frame
- ◇ 6” Tilling Depth
- ◇ Quick-Hitch Compatible

Model	Working Width	Blades per flange	Drive	HP	Weight (lbs.)	Ship Weight (lbs.)	List Price
<b>COMPACT SERIES</b>							
TXG-040	41”	6	Gear	15-30	337	392	\$1,985
TXG-050	48”	6	Gear	15-30	374	434	\$2,045
TXG-060	59”	6	Gear	18-30	412	477	\$2,155

Prices and specifications subject to change without notice. Check discounts & availability before quoting.  
Product Designs May Differ Slightly Than What Appears in the Photographs.

# MEDIUM DUTY ROTARY TILLER



Using quality components that are made to last, the YCT Series Rotary Tiller by Tar River Implements is built heavily enough to handle your tilling needs and for the price, it can cut through the competition.

Engineered for tractors from 30 to 60 Horsepower, the Tar River YCT Series Rotary Tiller comes with 6 blades per flange, slip clutch PTO protection and gear drive side transmission. It is available in 4', 5', 5.5', 6' and 7' models.

With its sleek and heavy design, paired with the quality components and its incredible price, the Tar River Rotary Tiller is ahead of its class.

**Quick Hitch Compatible**



**5 Year Gearbox Warranty Limited**

## YCT Series

\*Model Shown is YCT-074



### Specifications for YCT Series

- ◇ Gear Drive Transmission
- ◇ 6 Blades Per Flange
- ◇ PTO with Slip Clutch
- ◇ Powder Coat Paint
- ◇ Solid A Frame
- ◇ Large Diameter Rotor
- ◇ Labyrinth Rotor Bearing Shielding
- ◇ 7" Tilling Depth

Model	Working Width	Blades per flange	Drive	HP	Weight (lbs.)	Ship Weight (lbs.)	List Price
<b>MEDIUM DUTY SERIES</b>							
YCT-050	49"	6	Gear	30 - 50	525	554	<b>\$2,545</b>
YCT-060	58"	6	Gear	30 - 50	542	608	<b>\$2,710</b>
YCT-066	66"	6	Gear	35 - 50	596	669	<b>\$2,995</b>
YCT-074	72"	6	Gear	40 - 50	640	718	<b>\$3,125</b>
YCT-082	81"	6	Gear	45 - 60	702	757	<b>\$3,470</b>



# REVERSE ROTATION MD ROTARY TILLER



Tar River Implements is proud to provide the YCT-R Series Reverse Rotation Rotary Tiller. Reverse Rotation tillers provide a cleaner and smoother finish in less passes than a forward rotation tiller. These tillers will cut the overlying growth and bury them under the surface.

Engineered for tractors from 30 to 60 Horsepower, the Tar River YCT-R Series Rotary Tiller comes with 6 blades per flange, slip clutch PTO protection and gear drive side transmission. It is available in 5' and 6' working widths.



## YCT-R Series

\*Model Shown is YCT-R74



### Specifications for YCT-R Series:

- ◇ Gear Drive Transmission
- ◇ 6 Blades Per Flange
- ◇ PTO with Slip Clutch
- ◇ Powder Coat Paint
- ◇ Solid A Frame
- ◇ Large Diameter Rotor
- ◇ Labyrinth Rotor Bearing Shielding
- ◇ Front Dirt Shield
- ◇ 7" Tilling Depth

Model	Working Width	Blades per flange	Drive	HP	Weight (lbs.)	Ship Weight (lbs.)	List Price
<b>REVERSE TINE MEDIUM DUTY SERIES</b>							
YCT-R60	58"	6	Gear	30 - 50	557	623	\$2,960
YCT-R74	72"	6	Gear	40 - 50	654	734	\$3,375

Prices and specifications subject to change without notice. Check discounts & availability before quoting.  
Product Designs May Differ Slightly Than What Appears in the Photographs.

# HEAVY DUTY ROTARY TILLER



Built to suit the needs of larger tractors and more agricultural applications, the Tar River RXT Series Rotary Tiller is rated for up to 120 HP tractors. Using spiral center gearbox gears, extra thick rotor assembly and a tough A-frame, the RXT tiller can handle your roughest jobs.

Available in working widths of 66", 73" , 84 and 92".

## RXT Series

**Quick Hitch Compatible**



**5 Year Gearbox Warranty Limited**



### Specifications for RXT Series:

- ◇ Gear Drive Transmission
- ◇ 6 Blades Per Flange
- ◇ PTO with Slip Clutch
- ◇ Powder Coat Paint
- ◇ Large Diameter Rotor
- ◇ Solid A Frame
- ◇ Waterproof Rotor Supports
- ◇ 8" Tilling Depth

Model	Working Width	Blades per flange	Drive	HP	PTO Driveline	Weight (lbs.)	Ship Weight (lbs.)	List Price
<b>HEAVY DUTY SERIES</b>								
RXT-072	66"	6	Gear	50-120	Series 6 S/C	945	1,053	\$4,835
RXT-080	73"	6	Gear	55-120	Series 6 S/C	970	1,075	\$5,050
RXT-088	85"	6	Gear	60-120	Series 6 S/C	1,015	1,121	\$5,365
RXT-096	92"	6	Gear	65-120	Series 6 S/C	1,069	1,183	\$5,505

# HD MULTI-SPEED GEARBOX ROTARY TILLER



Built heavy for agricultural applications, the Tar River CXT Series Rotary Tiller is rated for tractors up to 130 HP and available in working widths of 86", 95, 104", 112" and 121".

The CXT tillers are designed with multispeed gearboxes to handle your ever changing conditions. The multi-speed gearbox is designed for easy gear access to allow the rotor speed to be changed quickly as you move to different field conditions. A large thick walled rotor is sustained by water proof rotor supports for wet conditions. Decks are double layered to keep stone indentations to a minimum.

## CXT Series

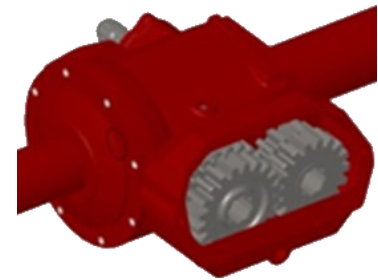
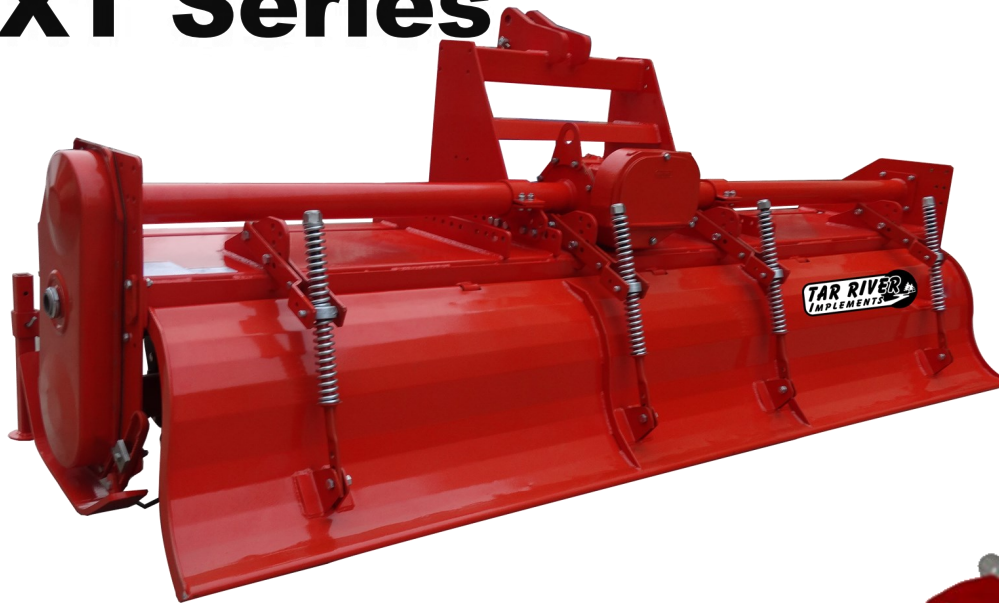

**MULTI-SPEED GEARBOX**  
To Adjust Rotor Speed

### Specifications for CXT Series:

- ◇ Gear Drive Transmission
- ◇ 6 Blades Per Flange
- ◇ PTO with Slip Clutch
- ◇ Powder Coat Paint
- ◇ Spiral Gears
- ◇ Large Diameter Rotor
- ◇ Solid A Frame
- ◇ Waterproof Rotor Supports
- ◇ 10" Tilling Depth

Model	Working Width	Blades per flange	Drive	HP	PTO Driveline	Weight (lbs.)	Ship Weight (lbs.)	List Price
CXT-095	95"	6	Gear	70-130	Series 8 S/C	1,762	1,862	\$8,475
CXT-104	104"	6	Gear	75-130	Series 8 S/C	1,876	1,895	\$9,425
CXT-112	112"	6	Gear	80-130	Series 8 S/C	2,081	2,317	\$10,635
CXT-121	121"	6	Gear	85-130	Series 8 S/C	2,115	2,410	\$11,335

Prices and specifications subject to change without notice. Check discounts & availability before quoting.  
Product Designs May Differ Slightly Than What Appears in the Photographs.

# TAR RIVER

Tar River Implements offers an economical solution to your seeding needs. The DRL-048 & DRL-072 come with double opening discs to plant grass, corn, beans, oats and more. The seeder comes equipped with two stainless steel boxes with closeable slides for each row. Apply fertilizer to each row while planting. The DLR is designed to be used as a secondary tillage tool. Ground conditions need to be worked up or tilled prior to use.



# CONVENTIONAL DRILL

FOR USE IN PREPARED GROUND

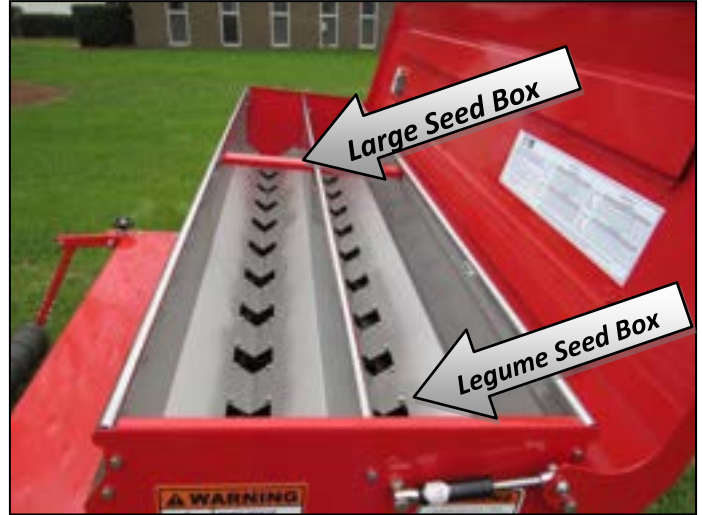

## Specifications:

- ◇ 6" Spacing
- ◇ Spring Loaded Double Disc Opener
- ◇ Disc Scrapers
- ◇ Divided Stainless Steel Hopper
- ◇ Standard Seed/Fertilizer seed cups on front and rear
- ◇ Full width Cage Roller
- ◇ Compaction scrapers
- ◇ Rear Roller
- ◇ DRL-048 Hopper Capacity: 3.50 Cu. Ft. Front Hopper  
2.50 Cu. Ft. Rear Hopper
- ◇ DRL-072 Hopper Capacity: 5.00 Cu. Ft. Front Hopper  
4.00 Cu. Ft. Rear Hopper



Model	Working Width	Working Depth	Min HP Req	Front Cup/Rear Cups	Spacing	Double Disc openers	Cat. Hitch	Weight (lbs.)	List Price
DRL-048	48"	3/4" - 2"	15	7+7	7"	7 Sets	1	569	\$3,595
DRL-072	68"	3/4" - 2"	20	10 + 10	7"	10 Sets	1 & 2	625	\$3,970

# TAR RIVER

The SAYA-505 (55") & SAYA-507 (78") got a facelift! They are still cost effective Light Duty No-Till Drills with front coulter package, but with new and improved features.

The 505 has 7 and the 507 has 10 swept back spring loaded double disc openers making seeding easy and economical. The Large seed and Legume cups allow for precise seeding in a no-till operation. **Stainless steel hoppers** prevent rust and keep your drill in fine working shape for years to come.

The **NEW** SAYA-907 has a 78" working width and comes with a 3 compartment seedbox which contain 3 different seedcups for seeding of any type of seed.

The front section comes with a dual section seedcup that splits between large seeds (corn and soybean sizes) to grass seeds such as wheat and rye. The middle section has a flow adjustable gearbox with special gear seedcups designed for the fluffy warm season Native grasses. There is no need to change chains and sprockets to adjust the flow. A simple handle on the gearbox smoothly increases or decreases seed output.

Both the front and middle seedcups feed into a heavy cast iron double disc opener.

The rear box contains high precision metering seedcups for the tiny legume seeds. Seeds dispersed from these cups are spread out behind the machine in order to prevent them from becoming buried too deep.

**Quick Hitch Compatible**



## SAYA-507



Warm Season Native Grass Box available on **SAYA-907 ONLY**. Perfect for metering Virginia Wildrye, Yellow Indiangrass, or a variety of other native grasses



# NO-TILL DRILL



## SAYA—Light Duty No-Till Drill For use in Light No-Till Applications

**Quick Hitch Compatible**

### Specifications:

- ◇ 7.5" Spacing
- ◇ Spring-Loaded Coulters discs
- ◇ Spring-Loaded Double Disc Opener with Cast Iron Hubs
- ◇ Cast Iron Swept-back Disc carriers
- ◇ Disc Scrapers
- ◇ Divided Stainless Steel Hopper
- ◇ Standard Seed/Fertilizer seed cups on front
- ◇ Legume Seed cups on rear
- ◇ Full width Cage Roller
- ◇ Compaction scrapers
- ◇ SAYA-505/507 — Front Hopper Capacity: 4.00/5.5 Cu. Ft.
- ◇ SAYA-505/507 — Rear Hopper Capacity: 3.00/4.5 Cu. Ft.
- ◇ SAYA-907 — Front Hopper/ Native Grass Box Capacity: 4.5 Cu. Ft.
- ◇ SAYA-907 — Rear Hopper Capacity: 3.8 Cu. Ft.



## SAYA-907

Model	Working Width	Working Depth	Min HP Req	Front Cup/ Rear Cups	Spacing	Double Disc openers	Cat. Hitch	Weight (lbs.)	List Price
SAYA-505	55"	3/4" - 2"	30	7	7.5"	7 Sets	1 & 2	1,036	\$6,210
SAYA-507	75"	3/4" - 2"	35	10	7.5"	10 Sets	1 & 2	1,400	\$7,930
SAYA-907	75"	3/4" - 2"	35	10	7.5"	10 Sets	1 & 2	1,499	\$8,975

Prices and specifications subject to change without notice. Check discounts & availability before quoting.  
Product Designs May Differ Slightly Than What Appears in the Photographs.

# GREENSCAPE

## 750 SERIES



High Precision Large Seedcup



Smaller Legume Seedcup



Greenscape 750 FOOD PLOTTER No-Till Drills are the latest in the Greenscape family of the most reliable seeders produced in the US over the past 20 years. High precision seed boxes and flow control make seeding a breeze with the ability to drill many different varieties and sizes of seed into all types of planting conditions.

Heavy built, but constructed to be able to be handled by tractors as low as 40 HP, The FOODPLOTTER line is designed for planting deer food plots around woodlands or high precision pasture seeding in the fall.

The 10 coulters at 7.5" High precision large seed seedcups accurately drop seeds into the openings. A separate Legume Seedbox with high precision seed cups accurately drop seed along a "splash pan" that rains the small seed over the soil. A packer roller system with Nylon rings or optional cast iron rollers help press the seed into the ground and close up the cuts made by the disc openers.

The NEW 750-4 has all the same great qualities of the 750-2 but with a Warm Season Native Grass Box. Perfect for metering Virginia Wildrye, Yellow Indiangrass, or a variety of other native grasses!

### Specifications:

- ◇ Three Point Hitch Cat. 1&2
- ◇ Heavy tubular frame construction
- ◇ All ground driven, no PTO shaft or gearbox to maintain
- ◇ Precise seed metering cups with individual clean out gates
- ◇ Rear roller packer rings to firm and smooth seedbed
- ◇ Water tight seed box with agitator shaft - calibration chart and seeding rate chart
- ◇ 10 Cast Iron double disc openers spaced at 7.5"
- ◇ Spring loaded coulters to cut through tough ground
- ◇ Optional Cast Iron roller rings



# NO-TILL DRILL



**Quick Hitch Compatible**



Simple & Highly Accurate Fluted Seedcup Adjustment System



Nylon Corrugated Cultipacker Rings  
Optional Cast Iron



**NEW! MODEL**



Shearpin for Seedcup Safety



High Precision Ground Drive Seeding System.



Warm Season Native Grass Box available on **750-4 ONLY**. Perfect for metering Virginia Wildrye, Yellow Indiangrass, or a variety of other native grasses

Model	Description	Weight (lbs.)	Ship Weight (lbs.)	List Price
750-2	75" No-Till Drill with Large Seed and Precision Legume Seedbox	1,771	1,942	\$12,580
750-4	75" No-Till Drill with Large Seed, Precision Legume, and Warm Season Native Grass Seedbox	1,974	2,145	\$15,950
OPTIONAL EQUIPMENT				
GSC-024	Cast Iron Rings (in lieu of nylon rings)			\$750
GSC-750CR	Complete Set of Aftermarket Cast Iron Rings			\$1,555

Prices and specifications subject to change without notice. Check discounts & availability before quoting.  
Product Designs May Differ Slightly Than What Appears in the Photographs.



# GREENSCAPE

The Greenscape represents a totally new concept in seeding. Being neither a grain drill nor a PTO driven seeder, the Greenscape effectively prepares the soil, drops and lightly covers the seed, and then firmly presses the soil for a perfectly prepared seedbed. It is designed to achieve a perfect pattern across the working width of the machine; no row effect as with drills or knife type over seeders.

Ground driven – no PTO shafts or gearboxes to maintain, and requires only a 35 HP (50 HP on 84” model) tractor to operate. When equipped with the optional precision small seed box and Native Seed box the Greenscape will plant virtually any type or size seed at any rate.

This machine will seed into all conditions, including primary seeding into prepared ground or overseeding into existing vegetation. Available in 60” and 84” working widths.

## Specifications:

- ◇ Three Point Hitch Cat. 1&2
- ◇ Heavy tubular frame construction
- ◇ All ground driven, no PTO shaft or gearbox to maintain
- ◇ Precise seed metering cups with individual clean out gates
- ◇ Rear roller packer rings to firm and smooth seedbed
- ◇ Water tight seed box with agitator shaft - calibration chart and seeding rate chart
- ◇ Driven spiked rollers crumble soil just enough for perfect seed-to-soil contact
- ◇ Exclusive Torque Arm - keeps constant adjustable down pressure on rear cultipacker
- ◇ Broadcast across full width of working area - no row effect as with PTO driven, knife type machines or sod drills

## Benefits:

- ◇ High ground speed – up to 7 MPH
- ◇ Full width broadcast coverage  
*NO ROW EFFECT*
- ◇ Seed or overseed in any condition
  - Fields
  - Groomed Turf
  - Prepared ground
- ◇ Abrasive-Resistant mining steel tines for extremely high wear
- ◇ Front Roller aggressively drives second roller 42% faster
- ◇ High quality – High precision seed cups for precise seed distribution
- ◇ Seed disengagement system for aeration & Seedcup safety shear pin
- ◇ Reinforced Nylon or Cast Iron corrugated roller rings
- ◇ Quick Hitch compatible reinforced three-point (Cat 1 & 2)
- ◇ Available Hoppers
  - Standard Large-Seed Box
  - Precision Legume Seed box
  - Native Grass Seed Box
  - Stainless Steel Fertilizer box

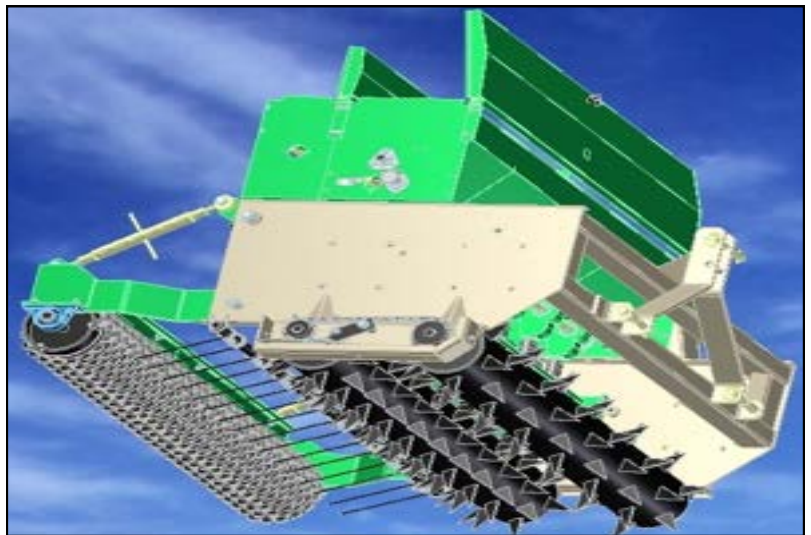

Front Pulverizer Bar



Seeder with 3 Boxes

# CONSERVATION SEEDER

**Quick Hitch Compatible**



**MODEL 600**



**MODEL 840**

Model	Description	60" Model	Weight (lbs.)	Ship Weight (lbs.)	List Price
600-1	60 Inch Base Unit with 1 large-grass Seed box		1,325	1,545	<b>\$8,480</b>
600-2	60 Inch Base Unit with 1 large-grass Seed box + 1 Precision Legume Seed box		1,380	1,600	<b>\$9,975</b>
600-3	60 Inch Base Unit with 1 large-grass Seed box + 1 Precision Legume Seed box + 1 Stainless Steel Fertilizer Hopper		1,490	1,710	<b>\$13,405</b>
600-4	60 Inch Base Unit with 1 large-grass Seed box + 1 Precision Legume Seed box + 1 Native Grass Seed box		1,557	1,710	<b>\$12,905</b>
600-5	60 Inch Base Unit with 2 large-grass Seed boxes + 1 Precision Legume Seed box		1,545	1,710	<b>\$12,420</b>
Model	Description	84" Model	Weight (lbs.)	Ship Weight (lbs.)	List Price
840-1	84 Inch Base Unit with 1 large-grass Seed box		1,960	2,210	<b>\$13,060</b>
840-2	84 Inch Base Unit with 1 large-grass Seed box + 1 Precision Legume Seed box		2,084	2,334	<b>\$14,940</b>
840-3	84 Inch Base Unit with 1 large-grass Seed box + 1 Precision Legume Seed box + 1 Stainless Steel Fertilizer Hopper		2,315	2,565	<b>\$18,950</b>
840-4	84 Inch Base Unit with 1 large-grass Seed box + 1 Precision Legume Seed box + 1 Native Grass Seed box		2,409	2,659	<b>\$18,660</b>
840-5	84 Inch Base Unit with 2 large-grass Seed boxes + 1 Precision Legume Seed box		2,315	2,565	<b>\$17,900</b>

**OPTIONAL EQUIPMENT:**

Model	Description	List Price
GSC-001	Cast Iron Rings - 600 Model (in lieu of nylon rings)	<b>\$565</b>
GSC-004	Cast Iron Rings - 840 Model (in lieu of nylon rings)	<b>\$795</b>
GSC-003	Rear roller scraper - 600 Models Nylon	<b>\$195</b>
GSC-005	Rear roller scraper - 840 Models Nylon	<b>\$255</b>
GSC-007	Rear roller scraper - 600 Models Cast Iron	<b>\$195</b>
GSC-006	Rear roller scraper - 840 Models Cast Iron	<b>\$255</b>
GSC-016	Road Light Kit - All Models	<b>\$390</b>
GSC-600R	Complete Set of Aftermarket Cast Iron Rings (600 Model)	<b>\$1,245</b>
GSC-840CR	Complete Set of Aftermarket Cast Iron Rings (840 Model)	<b>\$1,690</b>

Prices and specifications subject to change without notice. Check discounts & availability before quoting.  
 Product Designs May Differ Slightly Than What Appears in the Photographs.



# DISC HARROW WITH SEEDER

The DHDS-63 is a durable disc harrow with seeder. It is equipped with 10 disc heads in the front and back, which efficiently cuts and pulverizes the soil, creating an ideal seedbed for optimal germination. With its adjustable disc heads and precise seed metering system, the DHDS-63 provides accurate and uniform seed distribution. The front box distributes the seed into the disced soil. This allows for a deeper planting depth. The rear seed box has the legume seed cups and the seeds are distributed behind the disced area and rolled in the ground by the rear roller.



**Quick Hitch Compatible**



**Transport Position**  
Unit Folds into Transport Position for easy and hassle free moving.



Model	Working Width	Working Depth	Min HP Req	Front Cup/Rear Cups	Disc Heads	Cat. Hitch	Weight (lbs.)	List Price
DHDS-63	63"	3" - 4"	25	7	10 (front & rear)	1	803	\$7,250

# CRIMPER



**Quick Hitch Compatible**

The Tar River Implement Roller Crimper is a tool designed to terminate cover crops by crimping the stalk rather than cutting it during its “dough stage”. This process has several benefits, including the conservation of soil moisture, reduction of erosion, lessens the need for herbicides and addition of organic matter to the soil. It also suppresses weed growth and helps to cool soil temperatures during the summer months.

It is available in an 6’ and 8’ working widths and is a useful tool for farmers and agricultural professionals who want to manage their soil health.



Model	Working Width	Overall Width	Min. HP	Cat. Hitch	Weight (lbs.)	Max Weight w/ Water	List Price
<b>CMP-6</b>	72"	77"	30	CAT 1-2	1,127	1,564 lbs.	<b>\$5,775</b>
<b>CMP-8</b>	96"	100"	40	CAT 1-2	1,404	1,987 lbs.	<b>\$6,525</b>

# CHAIN HARROWS



## DRAG HARROWS—BARS ONLY

Model	Description	Recommended Sections	Weight (lbs.)	List Price
24-110487	4' Bar	ONE 4' x 4' section	22	\$115
24-110488	6' Bar	ONE 6' x 8' section	33	\$155
24-110489	8' Bar	TWO 4' x 8' sections	43	\$195
24-110490	10' Bar	TWO 10' x 4' sections	54	\$255
24-110491	12' Bar	TWO 6' x 8' sections	64	\$295

## DRAG HARROWS—SECTION ONLY

24-202111	4' x 4' x 1/2" chain	75	\$275
24-202112	4' x 8' x 1/2" chain	133	\$500
24-202113	6' x 8' x 1/2" chain	216	\$765
24-202114	10' x 4' x 1/2" chain	179	\$695
24-202115	10' x 8' x 1/2" chain	358	\$1,335

## 3—POINT FRAMES (Carrying frame only. Drawbar and Sections NOT INCLUDED)

Model	Description	Weight (lbs.)	List Price
BHL6/8	6'/8' 3-Pt. Mounted Harrow Lift	144	\$1,150
BHL10	10' 3-Pt. Mounted Harrow Lift	150	\$1,250
BHL12	12' 3-Pt. Mounted Harrow Lift	180	\$1,450

## ATV HARROWS—COMPLETE

ATV4	4' ATV Mini Harrow	105	\$515
ATV6	6' ATV Mini Harrow	165	\$750

# CARTED CHAIN HARROWS



Dethatch dead growth and rejuvenate grass and pasture fields with the Tar River Carted Harrow. Available in 20' and 24' working widths, the heavy 5/8" harrow tines keep your pasture healthy and vibrant.

The sturdy design of the Tar River Carted Harrow which easily folds into transport position makes it the obvious choice for your pasture renovation needs.

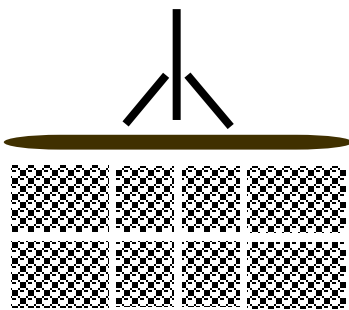

20' Carted Harrow

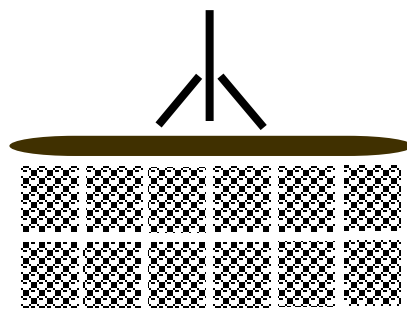

24' Carted Harrow



Model	Description	Center Sections	Wing Sections	Wing Fold	List Price
CH-20	20' Carted Harrow	2 each 4' x 6' x 5/8" chain	1 each 6' x 6' x 5/8" chain	Hydraulic	\$11,950
CH-24	24' Carted Harrow	2 each 4' x 6' x 5/8" chain	2 each 4' x 6' x 5/8" chain	Hydraulic	\$12,750

Prices and specifications subject to change without notice. Check discounts & availability before quoting.  
Product Designs May Differ Slightly Than What Appears in the Photographs.

# CAST IRON PASTURE HARROW



**Quick Hitch Compatible**

Take care of your pasture fields and horse arenas with four sizes of the Tar River Cast Iron Pasture Harrow.

Cat. 1, 3 point hitch compact design make it easy to hook up and store. The reversible cast iron tines and the heavy tubular design will give you years of use.



## Specifications

- ◇ Heavy Duty pipe frame
- ◇ Cat 1, 3 Point w/Cat.2 Bushings (on some models)
- ◇ Cat 1 QH adaptable
- ◇ Cast Iron Star tines
- ◇ Reversible
- ◇ Distributes and pulverizes manure, seed bed prep, renovate pastures, horse arenas, ballfields, levels mole hills, etc.



Model	Description	Tines	Fold	Transport Width	Weight (lbs.)	List Price
<b>WH06</b>	6' Pasture Harrow	Cast Iron	Manual	4' 3"	275 lbs.	<b>\$1,025</b>
<b>WH7.5</b>	7.5' Pasture Harrow	Cast Iron	Manual	4' 7"	296 lbs.	<b>\$1,145</b>
<b>WH13</b>	13' Pasture Harrow	Cast Iron	Manual	7'3"	507 lbs.	<b>\$2,175</b>
<b>WH20</b>	20' Pasture Harrow	Cast Iron	Hyd.	7'3"	811 lbs.	<b>\$3,950</b>



# FINISHING MOWERS



Keep your grassy areas looking good with the 100 Series Economy Finishing Mower by Tar River Implements. These mowers are great for compact tractors maintaining home estates and light landscaping. Available in working widths of 58", 71" and 82".

All Mowers come standard with safety chains. The BFM-107 model comes standard with front anti-scalp roller.



## Specifications:

- ◇ Solid Rubber Tires
- ◇ Rear Discharge
- ◇ Floating Hitch

- ◇ Easy Cutting Height Adjustment
- ◇ Easy Belt Tension Adjustment
- ◇ Powder Coat Paint
- ◇ Category 1 Hitch

Model	Working Width	Overall Width	HP	Number of Blades	Grass Discharge	Tires	Ship Weight (lbs.)	List Price
BFM-105	58"	59"	15-30	3	Rear Discharge	Solid Rubber	435	\$1,755
BFM-106	71"	72"	15-30	3	Rear Discharge	Solid Rubber	544	\$2,135
BFM-107	82"	86"	25-50	3	Rear Discharge	Solid Rubber	639	\$2,675

Prices and specifications subject to change without notice. Check discounts & availability before quoting.  
Product Designs May Differ Slightly Than What Appears in the Photographs.

# 3 PT. FLAIL MOWERS



Tar River Implements offers three versions of flail mowers.

Sub Compact version for tractors 25 HP and under, a Compact model version for 45 HP tractors and a Heavy-Duty model available in a center mount or a hydraulic offset version for 65 Hp tractors. In cutting widths from 53" to 87", the Tar River flail mowers are ready to take care of all your mowing needs.

## TREF SERIES—LIGHT DUTY



## TRMF SERIES—MED. DUTY



## FLM SERIES—HEAVY DUTY

### Specifications:

- ◇ Cat. 1 and Cat. 1&2 hitch on Offset Models
- ◇ Powder Coat Paint
- ◇ Heavy Cast Hammer Knives
- ◇ 3 & 4 Belt drive configurations
- ◇ Adjustable Height Control Rear Roller

Model	Working Width		HP	Weight (lbs.)	List Price
<b>SUBCOMPACT &amp; COMPACT FLAIL MOWERS</b>					
TREF-053	53"		15-25	453	\$2,480
TREF-061	61"		20-25	485	\$2,590
TRMF-061	61"		25-45	670	\$3,030
TRMF-077	77"		30-45	756	\$3,540
<b>HEAVY DUTY MOWERS</b>					
FLM-180	71"	CENTER MOUNT	30-60 HP	922	\$4,455
FLM-220H	87"	15.75" HYDRAULIC OFFSET	30-60 HP	1,060	\$5,375

# FLAIL MOWERS



## GARDEN Series

- ◇ Maintain grass areas with the ORSI Garden series flail mowers.
- ◇ Perfectly designed for small compact tractors. All units come equipped with Self-cleaning Roller, Counter Knife, and Free-Wheel Protection integrated inside the gearbox.
- ◇ Available in 51" and 59" working widths.

## FRUIT EXTRA Series

- ◇ Professional Mower for heavy brush cuttings and maintaining grass and cuttings in orchards or other areas where heavy cutting is needed.
- ◇ 1/4" Hardox frame holds up to punishing and pounding delivered in adverse conditions.
- ◇ Hydraulic Side shift allows the mower to be offset up to 20"



Model	HP	Working Width	Weight (lbs.)	Cutting Capacity	Blades	Belts	List Price
<b>3 POINT FLAIL MOWER—GRASS</b>							
GARDEN 130	18-35	51"	440	5/8"	"Y"	3	\$3,185
GARDEN 150	20-35	59"	485	5/8"	"Y"	3	\$3,375
<b>3 POINT FLAIL MOWER—ORCHARD</b>							
FRUIT EXTRA 180	60-130	71"	1,841	3 1/4"	Hammer	4	\$11,940



# DITCH BANK MOWERS



## ENERGY SERIES

Ditch bank mower for the smaller compact tractors with HP ratings from 20-50 HP. Popular sizes of 51" and 61" working widths make the Energy series ditch bank mower a "must have" for small farms that need to keep up mowing around ponds and ditches. The Energy ditch bank mower comes with a self-cleaning roller, counter knife, and free-wheel protection integrated inside the gearbox. A safety and self levelling breakaway system is a standard feature. Cat 1 hitch

## YOUNG SERIES

If you need 65 inches of cut, then the YOUNG series is the mower for you. Heavy frame and gearbox for tractors up to 65 HP.

3 Year warranty on the cast iron components, self cleaning roller, counter knife and free-wheel protection inside the gearbox.

Hammer knives hold up under harsh conditions.

Cat 1 hitch



## COMPETITION GS SERIES

The heavy duty COMPETITION GS Series is built tough for commercial applications. Double thick HARDOX (AR400 Equivalent) frame will hold up to the punishment for cutting road sides as well as ponds and ditch banks. 3 Year warranty on the cast iron components, self cleaning roller, counter knife and free-wheel protection inside the gearbox. Internal rotor bearings are protected from most impacts. Double-tapered roller bearings keep it rolling much longer than pillar block bearings. Comes standard with DOUBLE WIDE ANGLE PTO SHAFT.

Cat 2 hitch

# DITCH BANK MOWERS

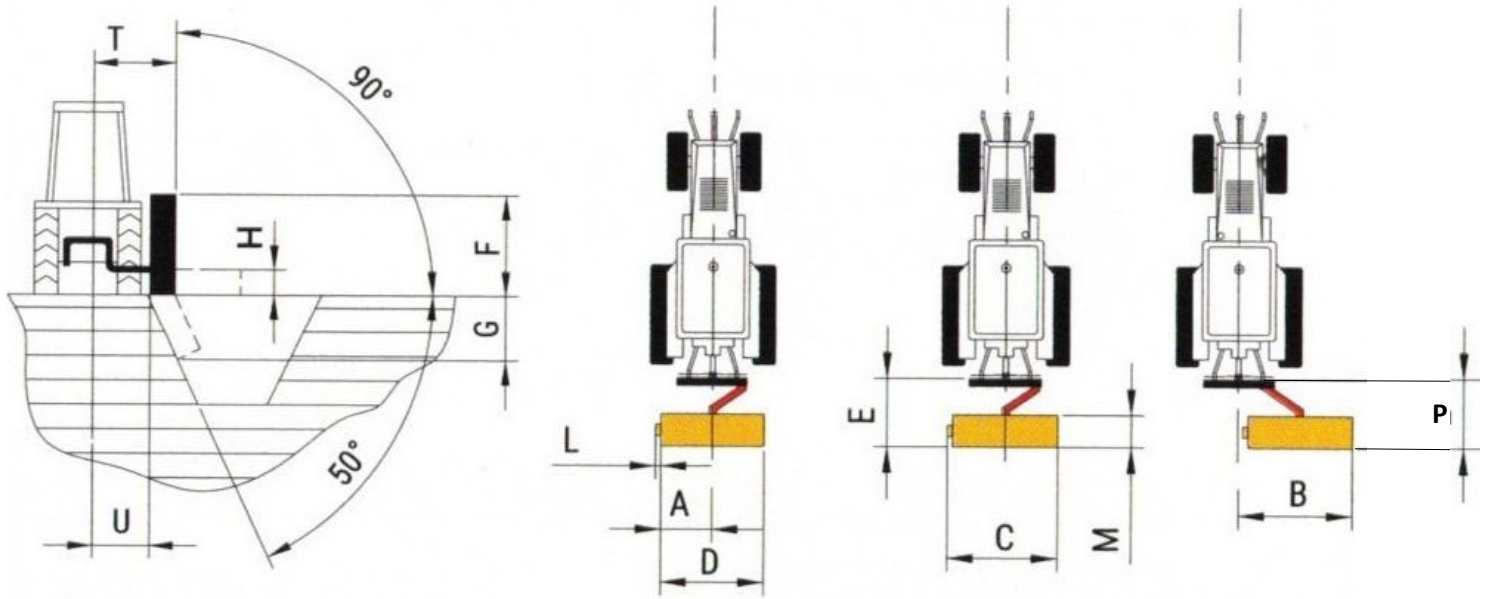

All measurements in Inches

	A	B	C	D	E	F	G	H	L	M	P	S	T	U
Energy 130	28	73	55	52	41	55	41	12	3	20	51	19	48	29
Energy 155	28	82	64	61	41	64	50	12	3	20	51	19	48	29
Young 165	33	83	70	64	63	97	48	17	6	28	76	19	59	35
Competition GS 180	32	109	81	71	72	108	52	19	9	39	80	24	70	51
Competition GS 200	32	117	89	79	72	116	59	19	9	39	80	24	70	51

Model	HP	Work Width	Weight (lbs.)	Cutting Capacity	Blades	Belts	List Price
<b>ENERGY SERIES</b>							
Energy 130	20-35	51"	511	1"	"Hammer"	3	\$6,320
Energy 155	20-50	61"	562	1"	"Hammer"	3	\$6,925
<b>YOUNG SERIES</b>							
Young 165	35-65	65"	1,047	1"	"Hammer"	4	\$10,560
<b>COMPETITION GS SERIES</b>							
Competition GS 180	50-80	71"	1,609	2 1/4"	"Hammer"	4	\$13,770
Competition GS 200	50-80	79"	1,653	2 1/4"	"Hammer"	4	\$14,310

Prices and specifications subject to change without notice. Check discounts & availability before quoting.  
Product Designs May Differ Slightly Than What Appears in the Photographs.

# DITCH BANK MOWERS



The Tar River hydraulic offset pivoting ditch bank mower is the ideal machine to maintain ditches and embankments around your property. The mount is just like a standard 3 point flail mower but when in full operating position this unit will also mow vertically up to 90° and down to 30/35°. All models come standard with heavy hammer knives and a perfectly balanced rotor for a smooth operation.



## TRDB-069



### SPECIFICATIONS

- ◇ Cat. 1&2 hitch
- ◇ Powder Coat Paint
- ◇ Heavy Cast Hammer Knives
- ◇ 3 & 4 Belt drive configurations
- ◇ Adjustable Height Control Rear Roller

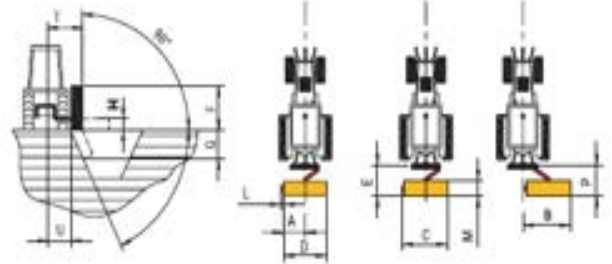

MODEL	A	B	C	D	E	F	G	H	L	M	P	ANGLE UP	ANGLE DOWN
TRDB-053	17	70	59	54	64	77	20	28	5	32	61	90°	30°
TRDB-061	17	78	67	62	64	85	24	28	5	32	61	90°	30°
TRDB-069	18	98	77	69	69	93	26	30	6	37	71	90°	35°

Model	Working Width	Cutting Angle	MIN HP	Weight (lbs.)	List Price
-------	---------------	---------------	--------	---------------	------------

### LIGHT AND MEDIUM DUTY DITCH BANK MOWERS

TRDB-053	53"	90° Up & 30° Down	30	664	\$3,795
TRDB-061	61"	90° Up & 30° Down	35	697	\$3,990
TRDB-069	69"	90° Up & 35° Down	45	1,002	\$5,370

# HYDRAULIC BOOM MOWERS



Tractor Range	28-75 HP
MIN Tractor Weight	1,800 lbs.
Cutting Head	39" Sickle Head
MAX Reach	11' 11"
Arm Tubing	100 x 80 x 4
Hitch	Cat. 1&2
Machine Weight	419 lbs.
MIN Oil Flow	4 GPM
Controls	Lever

MODEL	HP	Tractor Min. Wt.	Std. Head Inches	Controls	Weight (lbs.)	List Price
HEDGE 160	20-75	1,800	39"	Lever	419	\$9,390

# HYDRAULIC BOOM



**029**

## CUT REVERS

**GARDENING SERIES**



15 - 50 HP



Tractor Range	15-50 HP
MIN Tractor Wt.	1,800 lbs.
Cutting Head	32" Flail w/ Hammers
MAX Reach	10' 3"
Arm Tubing	80 x 80 x 4
Hitch	Cat. 1
Machine Weight	683 lbs.
Controls	Lever

MODEL	HP	Tractor Min. Wt.	Std. Head Inches	Controls	Weight (lbs.)	List Price
CUT 029	16-35	1,800	32"	Lever	683	\$17,595



# MOWERS



## RIVER COMPACT

AGRICULTURAL SERIES



25 - 60 HP



Tractor Range	25-60 HP
MIN Tractor Weight	River Compact 355: 3,300 lbs. River Compact 420: 4,000 lbs.
Cutting Head	River Compact 355: 41" Flail Mower with Hammers or 41" Rotary River Compact 420: 41" Flail Mower with Hammers or 41" Rotary
MAX Reach	River Compact 355: 11' 4" River Compact 420: 13' 11"
Arm Tubing	100 x 80 x 5
Hitch	Cat. 1&2
Machine Weight	River Compact 355: 1135 lbs. River Compact 420: 1312 lbs.
Annual Use	Up to 250 hours
Controls	Lever

MODEL	Hours per year	HP	Tractor Min. Wt.	Std. Head Inches	Controls	Weight (lbs.)	List Price
RIVER COMPACT 355	250	25-55	3,300	41"	Lever	1,135	\$19,125
RIVER COMPACT 420	250	25-55	4,000	41"	Lever	1,312	\$20,450

Prices and specifications subject to change without notice. Check discounts & availability before quoting.  
Product Designs May Differ Slightly Than What Appears in the Photographs.

# HYDRAULIC BOOM



Tractor Range	50-100 HP
MIN Tractor Weight	River Compact Plus 450: 4,000 lbs. River Compact Plus 580: 4,900 lbs.
Cutting Head	41" Flail Mower with Hammers or 41" Rotary
MAX Reach	River Compact Plus 450: 14' 8" River Compact Plus 580: 19' 2"
Arm Tubing	100 x 80 x 5
Hitch	Cat. 1&2
Machine Weight	River Compact Plus 450: 1477 lbs. River Compact Plus 580: 1676 lbs.
Annual Use	Up to 400 hours
Controls	Easy-Tronic Joystick



MODEL	Hours per year	HP	Tractor Min. Wt.	Std. Head Inches	Controls	Weight (lbs.)	List Price
RIVER COMPACT Plus 450	400	50-90	4,000	41"	Joystick	1,477	\$24,420
RIVER COMPACT Plus 580	400	50-90	4,900	41"	Joystick	1,676	\$26,950

# MOWERS



105 DEGREE SWIVEL



## PERFORMANCE

AGRICULTURAL SERIES



60 - 110 HP



Tractor Range	60-110 HP
MIN Tractor Weight	4,200 lbs.
Cutting Head	49" Flail Mower with Hammers or 41" Rotary
MAX Reach	14' 11"
Arm Tubing	120 x 100 x 5
Hitch	Cat. 2
Machine Weight	1808 lbs.
Annual Use	Up to 400 hours
Controls	Easy-Tronic Joystick

**EASY-TRONIC**



MODEL	Hours per year	HP	Tractor Min. Wt.	Std. Head Inches	Controls	Weight (lbs.)	List Price
PERFORMANCE 455	400	45-100	4,200	49"	Joystick	1,808	\$29,355

Prices and specifications subject to change without notice. Check discounts & availability before quoting.  
Product Designs May Differ Slightly Than What Appears in the Photographs.

# HYDRAULIC BOOM



**PERFORMANCE PARALLELOGRAM**  
AGRICULTURAL SERIES



60 - 110 HP



Tractor Range	60-110 HP
MIN Tractor Weight	5,100 lbs.
Cutting Head	49" Flail Mower with Hammers or 41" Rotary
MAX Reach	16' 7"
Arm Tubing	120 x 100 x 5
Hitch	Cat. 2
Machine Weight	1907 lbs.
Annual Use	Up to 400 hours
Controls	Easy-Tronic Joystick

**EASY-TRONIC**



MODEL	Hours per year	HP	Tractor Min. Wt.	Std. Head Inches	Controls	Weight (lbs.)	List Price
PERFORMANCE P510	400	45-100	5,100	49"	Joystick	1,907	\$34,365

# MOWERS



## PERFORMANCE PARALLELOGRAM VISUAL

AGRICULTURAL SERIES



70 - 110 HP



Tractor Range	70-110 HP
MIN Tractor Weight	5,100 lbs.
Cutting Head	49" Flail Mower with Hammers or 41" Rotary
MAX Reach	16' 7"
Arm Tubing	120 x 100 x 5
Hitch	Cat. 2
Machine Weight	1907 lbs.
Annual Use	Up to 400 hours
Controls	Easy-Tronic Joystick

**EASY-TRONIC**



SINGLE MOVEMENTS



MODEL	Hours per year	HP	Tractor Min. Wt.	Std. Head Inches	Controls	Weight (lbs.)	List Price
PERFORMANCE P510 Visual	400	45-100	5,100	49"	Joystick	1,907	\$38,700

Prices and specifications subject to change without notice. Check discounts & availability before quoting.  
Product Designs May Differ Slightly Than What Appears in the Photographs.

# HYDRAULIC BOOM MOWERS

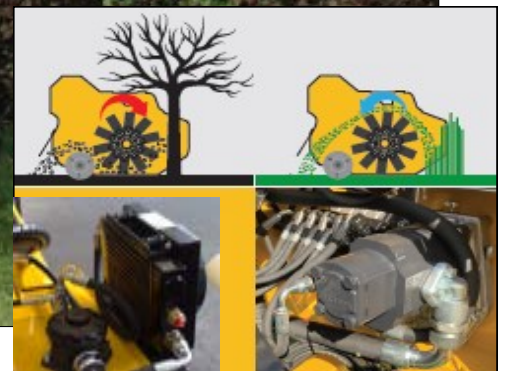
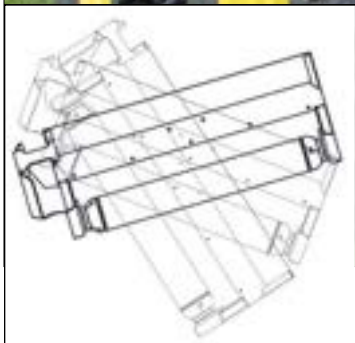

	Hours per year	HP	Tractor Min. Weight (lbs.)	Std. Head Inches	Controls	Weight (lbs.)
HEDGE 160	-	20-75	1,800	39"	Cable	418
CUT 029	-	16-35	1,800	32"	Cable	682
RIVER COMPACT 355	250	25-55	3,300	41"	Cable	1,135
RIVER COMPACT 420	250	25-55	4,000	41"	Cable	1,312
RIVER COMPACT Plus 450	400	50-90	4,000	41"	Joystick	1,477
RIVER COMPACT Plus 580	400	50-90	4,900	41"	Joystick	1,676
PERFORMANCE 455	400	45-100	4,200	49"	Joystick	1,808
PERFORMANCE P510	400	45-100	5,100	49"	Joystick	1,907
PERFORMANCE P510 Visual	400	45-100	5,100	49"	Joystick	1,907



# ROTARY CUTTERS

Front and Rear Chain  
Shielding STANDARD!

Slip Clutch STANDARD  
on 5' and 6' Models



3 Year  
Gearbox  
Warranty  
Limited

Designed to help dealers compete with the big box stores, Tar River Implements introduces the ERC Rotary Cutters. These mowers have front & rear chains standard, are built for 20-55 HP tractors and have a 5 Year Gearbox Warranty (1 year on the rest). They come with shear pin or slip-clutch PTOs, cut capacity of 1 1/2", pan-type stump jumpers and in working widths of 4', 5' and 6'.

### Specifications:

- ◇ 45 HP Gearbox
- ◇ Shear Pin PTO on 4' - Slip Clutch on 5' & 6'
- ◇ 4' - 12 GA Deck
- ◇ 5' - 11 GA Deck
- ◇ 6' - 9 GA Deck
- ◇ Cat. 1 Hitch w/ Floating Top Link
- ◇ 1 1/2" Cutting Capacity
- ◇ Laminated Wheels & Re-greaseable Hubs
- ◇ Pan Stump Jumper
- ◇ Safety Chain Shields Standard

Model	Working Width	PTO Protection	Min. HP	Weight (lbs.)	List Price
ERC-4	48"	Shear-Pin	20	411	\$1,595
ERC-5SC	60"	Slip Clutch	25	499	\$1,920
ERC-6SC	72"	Slip Clutch	35	734	\$2,620
OPTIONAL EQUIPMENT					
COM-147650	Slip Clutch Option for ERC-4				\$125

Prices and specifications subject to change without notice. Check discounts & availability before quoting.  
Product Designs May Differ Slightly Than What Appears in the Photographs.

# ROTARY CUTTERS



Front and Rear Chain  
Shielding STANDARD!



**HRC-7**



Tar River Implements introduces the MRC and HRC Rotary Cutters. These mowers have front & rear chains standard, are built for 40-90 HP tractors and have a 5 Year Gearbox Warranty. They come with slip-clutch PTOs and a cut capacity of 2”.

**Specifications:**

- ◇ 90 HP Gearbox
- ◇ 2” Cutting Capacity
- ◇ Laminated Wheels & Re-greaseable Hubs
- ◇ Solid Stump Jumper
- ◇ 7” Sides MRC-6 8” Sides HRC-7
- ◇ Deck Thickness 3mm & 5mm
- ◇ Replaceable Skids
- ◇ Safety Chain Shields Standard
- ◇ Cat.1 MRC-6 Cat.2 HRC-7
- ◇ MRC-6 one tailwheel & HRC-7 two tail wheels

Model	Working Width	PTO Protection	Min. HP	Tail Wheels	Weight (lbs.)	List Price
MRC-6	72”	Slip Clutch	40-90	1	725	\$2,995
HRC-7	84”	Slip Clutch	50-90	2	1,375	\$3,975



# SPREADERS



PULL-TYPE



**PTS-160P**



**BG-800**



**PTS-100**

Built with steel gears, this ground drive unit will hold up to the rigors of your everyday needs. Adjustable tow bar allows the spreader to be used on a multiple hitch height configurations. High floatation tires on a wide base give greater stability over many types of terrain.

**Specifications:**

- ◇ Heavy duty steel gears in gearbox
- ◇ Adjustable towing hitch
- ◇ High floatation tires
- ◇ Powder coated frame and hopper or Poly hopper
- ◇ Left – center – right spread pattern
- ◇ Optional spread deflector shield available

Model	Capacity (lbs.)	Capacity (Cu. Ft.)	Spread Swath	Hopper	Hopper Height	Tires	Weight (lbs.)	List Price
PTS-100	225	3.7	20'	Metal	40"	13" x 6"	75	\$630
PTS-100P	225	3.7	20'	Poly	40"	13" x 6"	70	\$715
PTS-160	360	5.3	20'	Metal	44"	16 1/2" x 8"	82	\$825
PTS-160P	360	5.3	20'	Poly	44"	16 1/2" x 8"	76	\$935
BG-800	1,885	27.5	52'	Metal	34"	20 x 10.0 x 8"	419	\$2,950

**OPTIONAL EQUIPMENT**

PTS-001	Deflector Shield	\$75
PTS-002	Cable Gate Opener Extension	\$285
	Spreader Assembly	\$35 (dealer net)

Prices and specifications subject to change without notice. Check discounts & availability before quoting.  
Product Designs May Differ Slightly Than What Appears in the Photographs.



# SPREADERS

## 3-POINT



High-quality spreaders with special heat-treated paint that resists rust. Easy and quick assembly, available in Poly and Steel hoppers.

### Specifications:

- ◇ Cat.1 three point hitch
- ◇ Dependable Gearbox
- ◇ Fixed Agitator (Optional Roller Wheel Agitator)
- ◇ Sturdy Metal Hopper With Special Heat-Treated Paint To Resist Rust
- ◇ Poly hopper with Stainless steel bottom and spreading fins

Model	Capacity lbs.	Capacity Cu. Ft	Hopper Height	Spread Swath	Weight (lbs.)	List Price
<b>STEEL HOPPER</b>						
SSS-300	716	8.6	40"	46'	115	<b>\$825</b>
SSS-500	1,058	12	46"	46'	133	<b>\$875</b>
<b>POLY HOPPER WITH STAINLESS STEEL BOTTOM AND FINS (PLASTIC ON SSC MODEL)</b>						
SSC-100	224	Cat. 0 & 1	23'	31'	83	<b>\$765</b>
SP-300SS	716	8.6	42"	46'	127	<b>\$925</b>
SP-500SS	1,121	12	46"	46'	135	<b>\$975</b>
<b>OPTIONAL EQUIPMENT</b>						
ARS-12	Roller Wheel Agitator (not available for SSC model)					<b>\$75</b>
	Spreader Assembly (2 = free assembly)					<b>\$35 (dealer net)</b>



# SPREADERS

## COMPACT SIDE SHOT

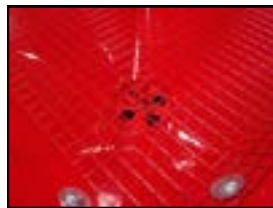

Designed for precise spreading of fertilizer and salt or sand. The material shoots out of the sides making it a perfect tool for winery/vineyards, blueberry farms, Christmas tree farms or anywhere else precise application is necessary.  
 "Side-Shot" components can be removed to use the spreader as any typical 3-Point mounted Fertilizer Spreader.

### Specifications:

- ◇ Designed for spreading fertilizer and salt
- ◇ Category 1 & 2 Hitch
- ◇ Stainless Steel Bottom
- ◇ Material shoots out of both left and right sides
- ◇ Standard Grate Filter & Hydraulic Lever Control for Spreader Gate

Model	Max Capacity	Spread Swath	Unit Dimensions (H x W)	Weight (lbs.)	List Price
SR-600	1,719 lbs.	26' - 59'	38" x 51"	229	\$2,785
SR-800	2,204 lbs.	26' - 59'	40" x 55"	264	\$2,975

### OPTIONAL EQUIPMENT

SR-002	Kit for 180 Degree Spread	\$160
--------	---------------------------	-------

Prices and specifications subject to change without notice. Check discounts & availability before quoting.  
 Product Designs May Differ Slightly Than What Appears in the Photographs.

# SPREADERS



## PENDULAR



Designed to provide excellent precision while at the same time being versatile enough to spread materials with different weights, textures, and sizes as well as high-moisture materials (up to 30% moisture content) such as powdered fertilizer.

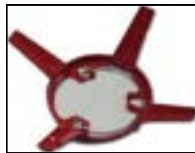

### Unit Dimensions (H x W x L)

45" x 46.5" Dia.

38" x 59" x 59"

47" x 59" x 59"

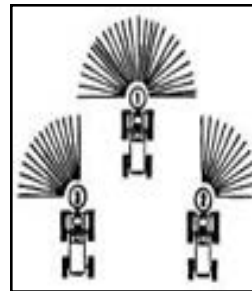
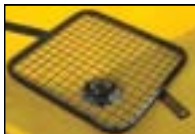

3 Possible Spread Patterns



Model	Max Capacity	Spread Swath		Weight (lbs.)	List Price
SPTO-350	795 lbs.	39' - 46' Granulated	16' - 19' Powdered	203	\$2,475
SQTF-600	1,402 lbs.	39' - 46' Granulated	16' - 19' Powdered	322	\$3,125
SQTF-1000A	2,645 lbs.	39' - 46' Granulated	16" - 19" Powdered	344	\$3,595

### OPTIONAL EQUIPMENT

SQTF-001	Salt & Sand Chute	\$185
SQTF-002	Rubber Chute Insert	\$70
SQTF-003	Hydraulic Lever Control	\$420
SQTF-004	Agitator Extension	\$95
SQTF-005	Grate Filter	\$165
	Spreader Assembly	\$50 (dealer net)

# LANDSCAPE RAKES



**Quick Hitch Compatible**



**Specifications:**

- ◇ Cat. 1 Quick Hitch Adaptable
- ◇ 5/16" x 4" x 4" Main Frame
- ◇ 5/16" x 1" Tempered Tines
- ◇ 4 Front & 4 Rear Angle Positions

**Tine Stiffener Standard!**

Add the finishing touch to your yard or work space. The Tar River Implements STR Series Landscape Rake is available in 4' - 8' working widths to fit most tractor needs. Tine stiffener comes standard.

Model	Working Width	HP Range	Weight (lbs.)	List Price
STR-4	48"	18-45	242	\$1,155
STR-5	60"	20-45	291	\$1,240
STR-6	72"	25-45	348	\$1,330
STR-7	84"	30-45	395	\$1,460
STR-8	96"	35-45	448	\$1,650

# REAR BLADES



**Quick Hitch Compatible**

**BRB-2  
STD. DUTY**



**BRB-9  
HVY. DUTY**



**BRB-5  
MED. DUTY**

Hydraulic Angling Cylinder  
Comes Standard on  
BRB-9 Series

Tar River Implements offers a full line of rear blades to fit your needs. From the Light Duty 60" blade for simple grading jobs all the way up to the 6-way Heavy Duty with Hydraulic Tilt, Angle and Offset in an 9' version for your toughest jobs.

Model	Working Width	M.Board Height	M.Board Thickness	M.Board Offset	M.Board Angle & Tilt	Max HP	Weight (lbs.)	List Price
<b>STANDARD DUTY ECONOMY - UP TO 40 HP - TILT &amp; ANGLE</b>								
BRB-205	60"	14"	1/4"	N/A	Yes	40	190	\$690
BRB-206	72"	14"	1/4"	N/A	YES	40	216	\$795
<b>MEDIUM DUTY ECONOMY - UP TO 60 HP - TILT, ANGLE &amp; OFFSET</b>								
BRB-506	72"	13"	1/4"	Yes	Yes	60	333	\$1,335
BRB-507	84"	13"	1/4"	Yes	Yes	60	355	\$1,395
BRB-508	96"	13"	1/4"	Yes	Yes	60	377	\$1,455
<b>6-WAY HEAVY DUTY - UP TO 90 HP - HYD. ANGLE, MANUAL TILT &amp; OFFSET STANDARD</b>								
BRB-907	84"	19"	1/4"	Yes	Yes	90	908	\$2,795
BRB-908	96"	19"	1/4"	Yes	Yes	90	939	\$3,225
BRB-909	108"	19"	1/4"	Yes	Yes	90	979	\$3,405
<b>OPTIONAL EQUIPMENT</b>								
BRB-009HC	Hydraulic Cylinder Kit for Tilt (on BRB-9 Series)							\$525

# DISC HARROWS



**Quick Hitch Compatible**

**NEW!  
SIZE**



Tar River Implements offers a range of Disc Harrows in different sizes to suit your needs. The DHC model is suitable for compact tractors up to 35 hp, featuring 16" notched blades. This series has 7 1/2" disc spacing and 1" square high strength axle re-greaseable flange bearings.

The DHS models are ideal for tractors with 25-50 hp. All units come with adjustable gang angles and are compatible with Category 1&2 quick hitch. Standard features include 18" notched blades, a sturdy main frame made of heavy duty 2 3/8" square tubing, and gangs with 1" square high strength axle re-greaseable flange bearings.

Model	Cutting Width	Spacing	Disc Size	# of Discs	HP	Weight (lbs.)	List Price
<b>COMPACT SERIES</b>							
DHC-4816	4'	7 1/2"	16"	12	15-35	430	\$1,450
DHC-6016	5'	7 1/2"	16"	16	15-35	496	\$1,675
<b>STANDARD SERIES</b>							
DHS-4818	4'	7 1/2"	18"	12	25-35	630	\$2,425
DHS-6018	5'	7 1/2"	18"	16	35-45	818	\$2,785
DHS-7418	6'2"	7 1/2"	18"	20	45-50	904	\$3,165
DHS-9020	7' 6"	9"	18"	20	50-60	970	\$3,475

# CULTIPACKER



Tar River Implements now has four sizes of Cultipackers available for your landscaping needs.

Designed for 18-40 hp tractors. They are made with a 2" square tube main frame. The packer wheels are 9 1/2" cast iron steel. Category 1 quick hitch compatible.

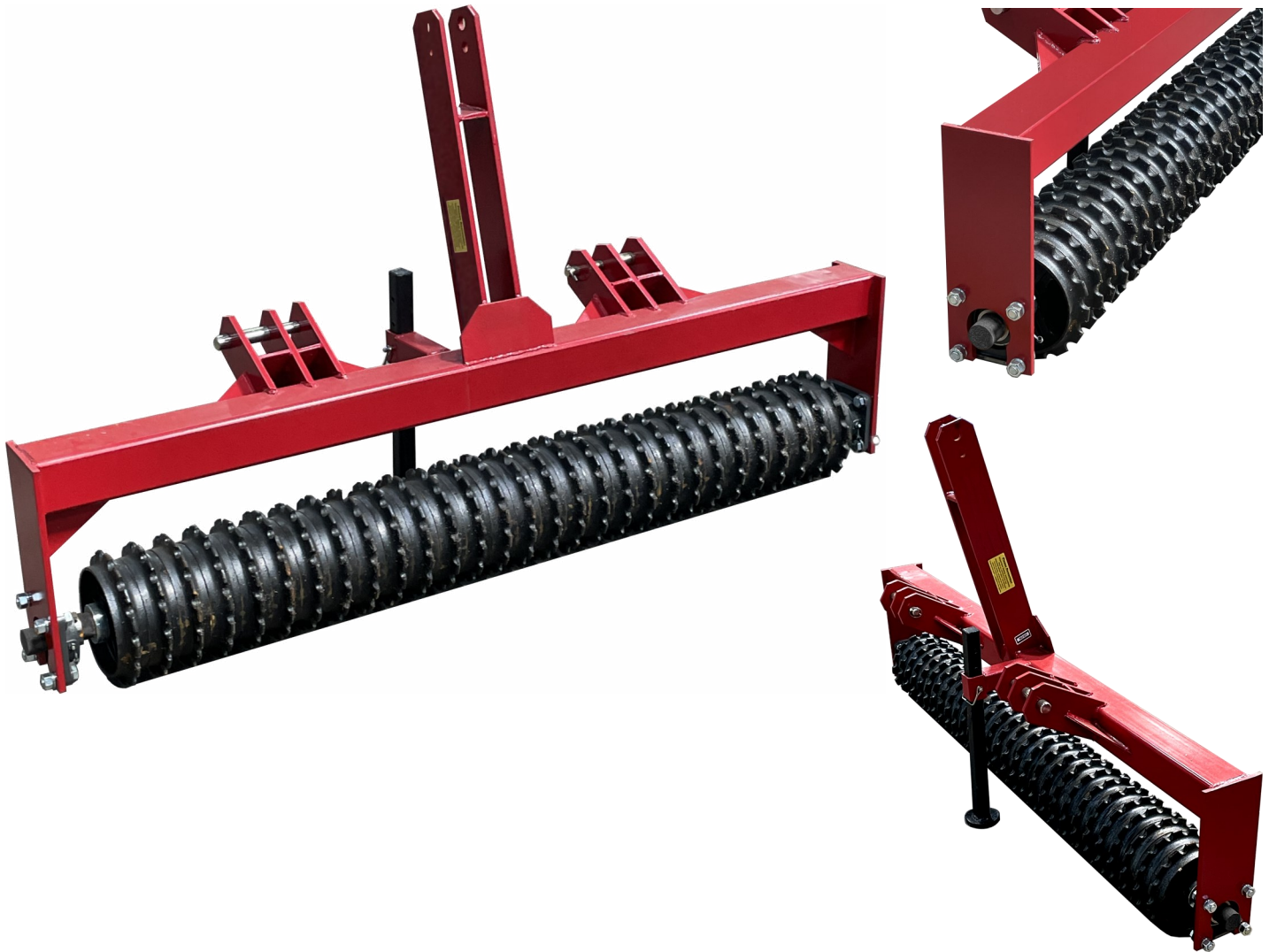

Model	Working Width	HP	Weight (lbs.)	List Price
CP-48L	48"	18-40	364	\$2,226
CP-60L	60"	18-40	439	\$2,469
CP-72L	72"	18-40	509	\$2,763
CP-84L	84"	18-40	578	\$3,096



# SHANK CULTIVATOR



The Tar River Implements Spring Loaded Cultivators are available in three sizes. They come in 36", 54" and 72" working widths and are made using 3/8" Steel angle iron with 3/4" wide shanks.



## Specifications:

- ◇ Suitable for stone and root filled soil; light and medium soil conditions
- ◇ Used for loosening and aerating soil up to 9 inches below the surface
- ◇ Prepares seedbeds quickly and economically
- ◇ When one tine strikes a hidden obstruction the others continue to work at the correct depth.
- ◇ Strength derived from heavy duty shanks, which once fixed to the frame cannot move or strain out of position
- ◇ Shovel to Shovel Distance 15"
- ◇ Height 21"

Model	Spring	Tines	Total Length	Working Width	Tractor Power (HP)	Weight (lbs.)	List Price
SLC-5	3/8" x 50"	3/8" x 2 1/2"	50"	36"	15-45	260	\$1,155
SLC-7			68"	54"	30-45	396	\$1,520
SLC-9			86"	72"	40-45	482	\$1,795

# BOX BLADES



**Quick Hitch Compatible**

Tar River Implements has Box Blades available in five popular sizes. The New Sub-Compact Box Blades come in 48" & 60" working widths and 1/4" side plates. The Medium Duty Box Blades come in 2 designs and in 60", 72", 84", and 96" working widths with 1/2" side plates (3/8" for 60" model). With its clevis hitches and durable design, the Tar River Box Blade is a great tool for all around dirt maintenance.

The front and rear replaceable 6" scraper blades allow for quick and easy replacement making the Tar River line of box blades an excellent choice for all your dirt moving needs!

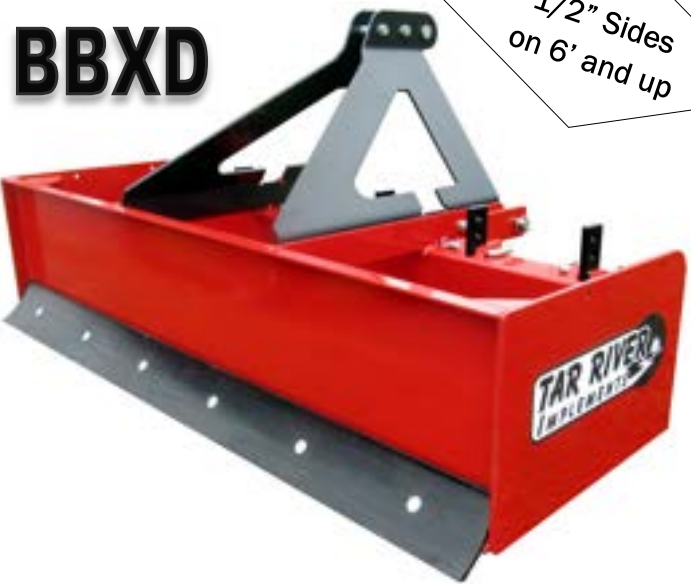
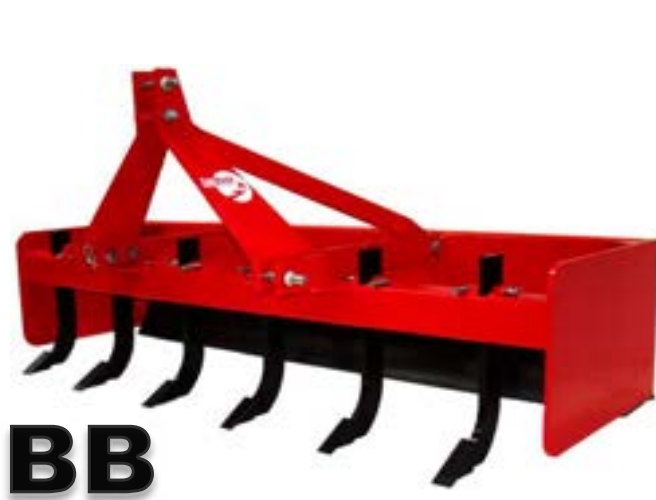

## Specifications:

- ◇ Sub-Compact available in 48" & 60" working widths
- ◇ Medium-Duty available in 60", 72", 84" & 96" working widths
- ◇ Clevis Hitch & Quick-Hitch Compatible
- ◇ Category 1 Hitch on 4,5 & 6. Cat 1&2 on 7 & 8 foot.
- ◇ 72", 84" & 96" models come with 1/2" side plates
- ◇ Heavy Duty A-Frame on BBXD Series

Model	Working Width	Side Plate Thickness	A-Frame Thickness	# Shanks	Max HP	Weight (lbs.)	List Price
<b>SUB-COMPACT MODELS</b>							
BB4SC	48"	1/4"	1/2"	4	24	343 lbs.	\$990
BB5SC	60"	1/4"	1/2"	5	24	390 lbs.	\$1,055
<b>MEDIUM DUTY MODELS</b>							
BB5	60"	3/8"	1/2"	5	50	502 lbs.	\$1,215
BB6	72"	1/2"	1/2"	6	50	548 lbs.	\$1,485
<b>HEAVY DUTY MODELS</b>							
BBXD7	84"	1/2"	1/2"	7	60	639 lbs.	\$1,695
BBXD8	96"	1/2"	1/2"	8	60	730 lbs.	\$1,915

# LAND LEVELER



Tar River Implements is proud to introduce the LB Series Land Leveler available in 3 popular sizes. These sturdy built units are great for a variety of applications from landscaping to work around the farm or homestead. Because they are not designed to move dirt, a lower HP tractor can use these.

Scarifier shanks (standard) and grading blades are multi-adjustable.



### Specifications:

- ◇ Cat. 1 Quick Hitch Adaptable
- ◇ Clevis Hitch
- ◇ Adjustable Grading Height & Ripping Shanks
- ◇ Replaceable Skid Shoes
- ◇ Scarifier Shanks come standard

Model	Working Width	Max HP	Weight (lbs.)	List Price
LB4	48"	50	455	\$1,655
LB5	60"	50	589	\$1,940
LB6	72"	50	700	\$2,190
LB7	84"	50	759	\$2,395

Prices and specifications subject to change without notice. Check discounts & availability before quoting.  
 Product Designs May Differ Slightly Than What Appears in the Photographs.



# WOOD CHIPPERS

The Tar River Wood Chipper is the perfect tool to help you clear your land of fallen limbs and branches. Use your wood chips to create beautifully covered flowerbeds and natural areas in the yard. Wood chips not only look nice, but they also help regulate soil temperature, retain moisture and even improve plant growth by helping release necessary nutrients into the soil.

The BWC-040EC is a manual feed chipper. It is PTO driven and available in a 4" chipping capacity.

The BWC-H Series are Self-Contained Hydraulic Feed Chippers. This series is available in 4", 6", and 8" chipping capacities. These chippers come equipped with internal hydraulic pumps that are run by the tractor PTO and require no external hydraulic feed.

Introducing the BWC-07DH to the Tar River Implements line of chippers. This chipper is a self contained Dual Hydraulic Roller Feed chipper. It has a 7" chipping capacity but a larger opening on the chute.

Reversible  
Blades!

**BWC-080-H**



**BWC-040EC**



**BWC-07DH**

# WOOD CHIPPERS



**Quick Hitch Compatible**

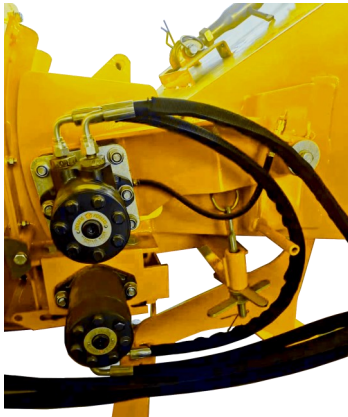

Double Feed Roller on BWC-07DH



Category 1 & 2 on 6" and higher models



**BWC-07DH**



Built In Temperature Gauge on BWC-07DH

Model	Chipping Capacity	HP	Chipper Wheel	Discharge Hood Height	Weight (lbs.)	List Price
<b>MANUAL FEED</b>						
BWC-040EC	4"	8-50	23.5" / 72 lbs.	59"	434	\$2,525
<b>SELF-CONTAINED HYDRAULIC FEED W/ PTO</b>						
BWC-040-H	4"	18-50	18.5" / 55 lbs.	74"	584	\$3,375
BWC-060-H	6"	35-100	24.8" / 128 lbs.	83"	794	\$3,875
BWC-080-H	8"	35-100	24.7" / 131 lbs.	81"	891	\$4,625
<b>DUAL-HYDRAULIC ROLLER FEED</b>						
BWC-07DH	7"	50-85	29.1" / 191 lbs.	90"	1,295	\$6,495

Prices and specifications subject to change without notice. Check discounts & availability before quoting. Product Designs May Differ Slightly Than What Appears in the Photographs.

# POST HOLE DIGGER



**NEW STAND AND  
LEVELER STANDARD!**

Tar River Implements introduces the BPH-100 3pt Post Hole Digger. Equipped with a Category 1 hitch and an 18-60 HP rated gearbox. Now standard with a stand and leveler. Three choices of augers, BPH-06A is a 6", BPH-09A is a 9" and the BPH-12A is a 12".

Model	Description	HP	Hitch	Weight (lbs.)	List Price
<b>POST HOLE DIGGER</b>					
BPH-100	Post Hole Digger	18-60	Cat 1	157	\$1,145
<b>AUGERS</b>					
BPH-06A	6" Auger			24	\$160
BPH-09A	9" Auger			35	\$190
BPH-12A	12" Auger			49	\$265

Packaged 2 per crate sizes can be mixed (additional cost if purchased individually)



# TRACTOR TOOLS

## Sub-Soiler / Middle Buster

- ◇ Cat. 1 Hitch
- ◇ Powder Coat Paint
- ◇ Adjustable Ripping/Digging Depth
- ◇ Heavy-Duty Steel Frame with Ripper Tooth (Sub-Soiler) and 14" Middle Buster

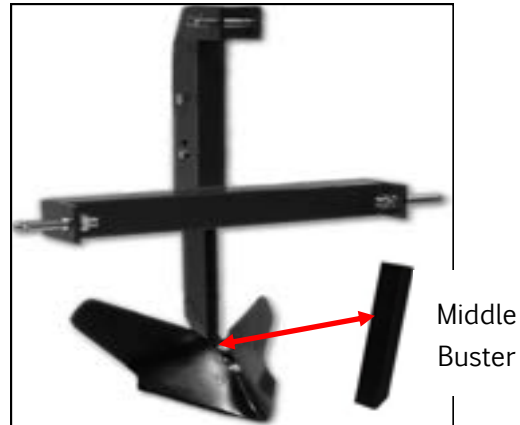

Middle Buster

## Hiller/Ripper

- ◇ Heavy Duty Construction (HKC1)
- ◇ Adjustable Row Width

\*\*A-HKC1 - Ripper Accessory sold separately  
List Price – \$75



## 1 & 2 Bottom Plows

- ◇ 1 Bottom Plow (PB1) with a 14" Bottom
- ◇ 2 Bottom Plow (PB2) with 16" Bottoms



Model	Description	Hitch	Misc. Info	Weight (lbs.)	List Price
<b>BSM-100</b>	Sub-Soiler / Mid Buster Combo	Cat. 1		79/88	<b>\$320</b>
<b>HKC1</b>	Hiller/Ripper	Cat. 1		192	<b>\$1,155</b>
<b>PB1</b>	1 Bottom Plow	Cat. 1	14" Bottom	186	<b>\$1,415</b>
<b>PB2</b>	2 Bottom Plow	Cat. 1	16" Bottoms	279	<b>\$2,495</b>



# TRACTOR

### 3 Pt. Bale Spear

- ◇ Standard 49" Spear
- ◇ 2,000 lb. Capacity
- ◇ Cat. 1 Hitch Pins



### Trailer Mover

- ◇ Designed to Move Empty Trailers with the Tractor's 3-Pt Hitch
- ◇ Category 1 Hitch (TM1&TM2)
- ◇ Trailer Ball & Receiver not Included



Ball & Receiver  
Not Included

### 3 Point Cultivator

- ◇ Adjustable Shank width
- ◇ 6 Reversible heat-treated shovels
- ◇ Welded steel angle frame
- ◇ Category 1 hitch pin
- ◇ Recommended for tractors less than 50 HP



Model	Description	Hitch	Misc. Info.	Weight (lbs.)	List Price
TPS1	Bale Spear - 3 Pt. Mount	Cat. 1	2,000 lb. Cap.	85	\$425
TM1	Trailer Mover SD	Cat. 1	2"x2" Post	35	\$275
TM2	Trailer Mover HD	Cat. 1	3.2" x 3.2" Post	56	\$320
TPC-6	3 Point Cultivator	Cat. 1	49" Width	96	\$370



# TOOLS



## Quick-Hitch Adapters

- ◇ Attach To Tractor For Quick & Easy Hook-Up For 3-Pt Implements
- ◇ Category 1 (QH1) or Category 2 (QH2) Adapters Available

## 3-Point 1200 lb. Pallet Fork

- ◇ Designed to carry 1200 lbs.
- ◇ Cat. 1 Hitch
- ◇ 26" High Frame and 46" Forks

## Clamp on Bucket Forks

- ◇ 2000 lbs. carrying capacity per pair
- ◇ Fork Dimensions 4" x 2" x 44"

## 3 Point Rear Weight Bracket

- ◇ Cat.1
- ◇ Quick hitch adaptable.
- ◇ 3 - 3/16" square tubing
- ◇ Fits up to 8 suitcase wts.
- ◇ 2 5/16" Ball
- ◇ 2" receiver
- ◇ 3/8" recovery hook



Model	Description	Hitch	Weight (lbs.)	List Price
QH1	Cat. 1 Adapter	Cat. 1	67	\$220
QH2	Cat. 2 Adapter Max 100HP	Cat. 2	102	\$375
PF	46" 3-Pt. Pallet Fork	Cat. 1	106	\$385
BFT2000	44" Clamp-on Bucket Forks	N/A	108/pair	\$425 (Pair)
RWB-1	3 pt. Rear Weight Bracket	Cat. 1	66	\$350
OPTIONAL EQUIPMENT				
QHA-1KIT	Quick Hitch Bushing Set—Cat. 1 (Parts Discount)			\$27
QHA-2KIT	Quick Hitch Bushing Set—Cat. 2 (Parts Discount)			\$23
QHA-25	Quick Hitch 1 Adapter Bracket (Parts Discount)			\$22

Prices and specifications subject to change without notice. Check discounts & availability before quoting.  
 Product Designs May Differ Slightly Than What Appears in the Photographs.

# TAR RIVER ATTACHMENTS

## NOTES AND GENERAL INFORMATION



**Standard Universal Skid Steer**



**Euro/Global**



**John Deere**

- ◇ Standard Mounting is **Universal Skid Steer Mount** (except when noted otherwise)
  - ◇ Euro/Global optional at additional costs—use prefix “EG”.
  - ◇ JD Mounts optional at additional costs—use prefix “JD”.
- Mounts fit these loaders:
  - ◇ 200X, 200CX, 210, 300, 300X, 300CX, 400, 400X, 400CX, 520, 521, 540, 541, 542
- ◇ Hydraulic Hoses & Flat Faced Couplers come standard when necessary with all units except when noted otherwise.

# PALLET FORKS - BUCKETS - GRAPPLES



## PALLET FORKS

Model	Description	Loader	Capacity	Fork Lengths	Weight
SCPF	Sub Compact	Sub-Compact	900 lbs.	36" or 42"	190 lbs. - 205 lbs.
CPF	Compact	Compact	2,000 lb. & 3,000 lb.	42" - 48"	235 lbs. - 274 lbs.
EPF	Economy	Compact or Utility	4,200 lb.	48"	395 lbs.
MPF	Medium Duty	Utility or Larger	4,200 lb.	42" or 48"	376 lbs. - 394 lbs.
HPF	Heavy Duty	Utility or Larger	5,200 lb.	48" or 60"	414 lbs. - 460 lbs.
WTPF & WTHPF	Walk Through	Skid Steer	4,200# & 5,200 lb.	42" - 48" - 60"	378 lbs. - 394 lbs.
HYPF	Hyd. Side Shift	Utility or Larger	4,200 lb.	48"	436 lbs.

## BUCKETS

Model	Description	Typical Uses
RB	Rock Bucket	Essential attachment for separating rocks from dirt as well as for clearing and building sites. Ideal for sifting out large rocks and debris. Catches rocks 3" plus.
LP	Low Profile Bucket	High visibility specifically designed for skid steer loaders. For general purpose grading and moving dirt.
LB	Long Bottom Bucket	Built heavy for large skid steer applications. An excellent attachment for precise grading and construction purposes. 35 1/2" deep to allow for easy view of front edge while working.
CU	Compact Utility	All around general purpose specifically made for tractor loaders.
XMB	Material Bucket	Material /Snow / Litter bucket is used for moving litter, chips, snow and other light material.
4N1	4-IN-1 Bucket	Multi-purpose bucket for grappling, dozing, backfilling , loading, digging and fine grading
DB	Disbursement Bucket	Bucket attachment for carrying concrete, filling grain feeders, moving gravel and dirt. .85 Yard struck Capacity
HDB	High Dump Bucket	This bucket allows an extra 3 feet of dumping height for full loading capacity of truck or spreader.
HDGB	Grapple Bucket	Multi-purpose tool combining bucket and grapple
SB	Stump Bucket	Attachment bucket designed to dig around stumps with its narrow cutting surface for easy stump removal. Great for digging narrow ditches for footings or storm ditches.

## GRAPPLES

Model	Description	Typical Uses
RG	Rock Grapple	A fundamental implement for separating rocks from dirt as well as for contractors clearing a lot for site building. It is also essential for storm damage clean up. The Rock Grapple is ideal for sifting out large rocks and debris. It is excellent in pastures, lawns or construction sites. It will catch any rock or piece of debris that is larger than 3 inches
SBG	Stump Bucket	Used for prying and removing stumps with the gripping power to secure the load
RG	Root Grapple	Moving logs, brush, rocks or many other types of debris. Available in single and double grapple configurations CRG (< 40 HP) HDRG1 (35-50 HP) HDRG2 (40-60HP) XRG (60+ HP)
BG	Brush Grapple	Deigned for tearing into roots, trash and rubbish and loading the debris into trucks or wagons. Designed to roll debris into tight piles.
HFG	Fork Grapple	An essential tool on the farm, logging and construction industry. Great for moving logs, fence posts, pipes and debris.
FG	Log Grapple	Unique rounded tine design to easily hold large logs, pipes, fence posts and culverts.

Prices and specifications subject to change without notice. Check discounts & availability before quoting.  
Product Designs May Differ Slightly Than What Appears in the Photographs.



# PALLET FORKS

## SUB-COMPACT PALLET FORKS

- ◇ Light, Durable Frame & Forks great for Sub-Compact Tractors
- ◇ **SCPF36** = 900 lbs. Lift Capacity - 36" forks
- ◇ **SCPF42** = 900 lbs. Lift Capacity - 42" forks
- ◇ Standard Universal Skid Steer Mount
- ◇ Optional JD Mount Available



## COMPACT PALLET FORKS

- ◇ Light, Durable Frame & Forks great for Compact Tractors
- ◇ **CPF42** = 2,000 lbs. Lift Capacity - 42" forks
- ◇ **CPF48** = 3,000 lbs. Lift Capacity - 48" forks
- ◇ Standard Universal Skid Steer Mount
- ◇ Optional JD Mount Available



## MEDIUM & HEAVY DUTY PALLET FORKS

- EPF SERIES** —
- ◇ 4,200 Lift Capacity
  - ◇ 48" Forks
  - ◇ Standard Universal Skid Steer Mount
  - ◇ Optional JD Mount Available

- MPF & HPF SERIES** —
- ◇ Use The Same Heavy Built Frames
  - ◇ Frames Are Rated For Up To 5,500 lbs.
  - ◇ The Only Difference Between The MPF & HPF Series are the Fork Ratings
  - ◇ The Same Applies For the Walk-Thru Forks

- MPF SERIES** —
- ◇ 4,200 lbs. Lift Capacity
  - ◇ 42" & 48" Forks Available
  - ◇ Walk-Thru Frames Available as **WTPF Series**
  - ◇ Standard Universal Skid Steer Mount
  - ◇ Optional JD & Euro/Global Mounts Available

- HPF SERIES** —
- ◇ 5,200 lbs. Lift Capacity
  - ◇ 48" & 60" Forks Available
  - ◇ Walk-Thru Frames Available as **WTHPF Series**
  - ◇ Standard Universal Skid Steer Mount
  - ◇ Optional JD & Euro/Global Mounts Available



**EPF SERIES**



**MPF SERIES**

# PALLET FORKS



Model	Description	Capacity	Mount	Weight	List Price	Packed
<b>SUB COMPACT FORKS - 900 LBS.</b>						
SCPF36	Sub Compact Pallet Forks - 36" Forks	900 lbs.	Uni. Skid Steer	161 lbs.	\$575	10
JDSCPF36	Sub Compact Pallet Forks - 36" Forks	900 lbs.	JD 200/300	150 lbs.	\$575	10
SCPF42	Sub Compact Pallet Forks - 42" Forks	900 lbs.	Uni. Skid Steer	171 lbs.	\$595	10
JDSCPF42	Sub Compact Pallet Forks - 42" Forks	900 lbs.	JD 200/300	160 lbs.	\$595	10
<b>COMPACT FORKS - 2,000 LBS. &amp; 3,000 LBS.</b>						
CPF42	Compact Pallet Forks - 42" Forks	2,000 lbs.	Uni. Skid Steer	253 lbs.	\$735	5
JDCPF42	Compact Pallet Forks - 42" Forks	2,000 lbs.	JD 200/300 and 400/500	253 lbs.	\$735	5
CPF48	Compact Pallet Forks - 48" Forks	3,000 lbs.	Uni. Skid Steer	274 lbs.	\$890	5
JDCPF48	Compact Pallet Forks - 48" Forks	3,000 lbs.	JD 200/300 and 400/500	274 lbs.	\$890	5
<b>MEDIUM DUTY FORKS - 4,200 LBS.</b>						
MPF42	Medium Duty Forks - 42" Forks	4,200 lbs.	Uni. Skid Steer	376 lbs.	\$1,150	5
EGMPF42	Medium Duty Forks - 42" Forks	4,200 lbs.	Euro/Global	376 lbs.	\$1,150	5
JDMPF42	Medium Duty Forks - 42" Forks	4,200 lbs.	JD 200/300 and 400/500	376 lbs.	\$1,150	5
MPF48	Medium Duty Forks - 48" Forks	4,200 lbs.	Uni. Skid Steer	394 lbs.	\$1,175	5
EGMPF48	Medium Duty Forks - 48" Forks	4,200 lbs.	Euro/Global	394 lbs.	\$1,175	5
JDMPF48	Medium Duty Forks - 48" Forks	4,200 lbs.	JD 200/300 and 400/500	394 lbs.	\$1,175	5
EPF48	Med. Duty Cage Design- 48" Forks	4,200 lbs.	Uni. Skid Steer	395 lbs.	\$995	5
JDEPF48	Med. Duty Cage Design- 48" Forks	4,200 lbs.	JD 200/300 and 400/500	395 lbs.	\$995	5
<b>HEAVY DUTY FORKS - 5,200 LBS.</b>						
HPF48	Heavy Duty Forks - 48" Forks	5,200 lbs.	Uni. Skid Steer	414 lbs.	\$1,210	5
EGHPF48	Heavy Duty Forks - 48" Forks	5,200 lbs.	Euro/Global	414 lbs.	\$1,210	5
JDHPF48	Heavy Duty Forks - 48" Forks	5,200 lbs.	JD 200/300 and 400/500	414 lbs.	\$1,210	5
HPF60	Heavy Duty Forks - 60" Forks	5,200 lbs.	Uni. Skid Steer	460 lbs.	\$1,285	5
EGHPF60	Heavy Duty Forks - 60" Forks	5,200 lbs.	Euro/Global	460 lbs.	\$1,285	5
JDHPF60	Heavy Duty Forks - 60" Forks	5,200 lbs.	JD 200/300 and 400/500	460 lbs.	\$1,285	5

Prices and specifications subject to change without notice. Check discounts & availability before quoting.  
Product Designs May Differ Slightly Than What Appears in the Photographs.

# PALLET FORKS



## HYDRAULIC PALLET FORKS

- ◇ Same Frame as our MPF48 but with welded-on 48" forks that can be moved hydraulically from side to side
- ◇ Available in 48" forks, 4,200 lbs. forks only
- ◇ Units Come Standard With Flat Faced Couplers & Hoses
- ◇ Standard Universal Skid Steer Mount
- ◇ Optional JD or Euro/Global Mounts



## HYPF SERIES



## WALK THRU PALLET FORKS

- ◇ 4,200 lbs. Lift Capacity
- ◇ 42" & 48" Forks Available
- ◇ Standard Universal Skid Steer Mount
- ◇ 5,200 lbs. Lift Capacity
- ◇ 48" & 60" Forks Available
- ◇ Standard Universal Skid Steer Mount

Model	Description	Capacity	Mount	Weight	List Price	Packed
<b>WALK-THRU MEDIUM DUTY FORKS - 4,200 LBS.</b>						
WTPF42	Walk-Thru Med. Duty Forks - 42"	4,200 lbs.	Uni. Skid Steer	378 lbs.	<b>\$1,150</b>	5
WTPF48	Walk-Thru Med. Duty Forks - 48"	4,200 lbs.	Uni. Skid Steer	396 lbs.	<b>\$1,175</b>	5
<b>WALK-THRU HEAVY DUTY FORKS - 5,200 LBS.</b>						
WTHPF48	Walk-Thru Heavy Duty Forks - 48"	5,200 lbs.	Uni. Skid Steer	416 lbs.	<b>\$1,210</b>	5
WTHPF60	Walk-Thru Heavy Duty Forks - 60"	5,200 lbs.	Uni. Skid Steer	462 lbs.	<b>\$1,285</b>	5
<b>HYDRAULIC PALLET FORKS</b>						
HYPF48	Hydraulic Shift Pallet Forks - 48"	4,200 lbs.	Uni. Skid Steer	436 lbs.	<b>\$2,475</b>	1
HYPF60	Hydraulic Shift Pallet Forks - 60"	4,200 lbs.	Uni. Skid Steer	493 lbs.	<b>\$2,585</b>	1

INDIVIDUAL TINES	Model	Size (in.)		List Price Per Tine
	COM-111802 — SCPF, JDSCPF	1 x 3 x 36	2A	<b>\$110</b>
	COM-111803 — SCPF, JDSCPF	1 x 3 x 42	2A	<b>\$120</b>
	COM-90222 — CPF, JDCPF	1.18 x 3 x 42	2A	<b>\$135</b>
	COM-80489 — CPF/JD, EFP/JD, MPF/JD/EG, WTPF	1.38 x 4 x 48	2A	<b>\$215</b>
	COM-83801 — HPF/JD/EG, WTHPF	1.5 x 4 x 48	2A	<b>\$235</b>
	COM-87132 — HPF/JD/EG, WTHPF	1.5 x 4 x 60	2A	<b>\$305</b>
	COM-401830 — OPTIONAL	1.5 x 4 x 72	2A	<b>\$375</b>

# BALE SPEARS



## LOADER MOUNT BALE SPEARS

- EBS Series** —
  - ◇ Standard Universal Skid Steer Mount Only
  - ◇ Single Spear Configuration Only
  - ◇ 49" Spear
  - ◇ 2,800 lbs. capacity
- BS Series** —
  - ◇ Standard Universal Skid Steer Mount
  - ◇ Optional JD & Euro/Global Mounts Available
  - ◇ Hi-Back Configurations Available (HBS Series)
  - ◇ Single, Double & Triple Spear Configurations Available
  - ◇ Standard 49" Spear
  - ◇ 3,500 lbs. capacity



Model	Description	Capacity	Mount	Weight	List Price	Packed
<b>LOADER MOUNT - SINGLE SPEAR</b>						
<b>EBS1</b>	Quick-Attach Bale Spear - 49"	2,800 lbs.	Uni. Skid Steer	157 lbs.	<b>\$645</b>	<b>8</b>
<b>BS1-HD</b>	Lo-Back Bale Spear - Single 49"	3,500 lbs.	Uni. Skid Steer	189 lbs.	<b>\$765</b>	<b>5</b>
<b>EGBS1-HD</b>	Lo-Back Bale Spear - Single 49"	3,500 lbs.	Euro/Global	189 lbs.	<b>\$880</b>	<b>5</b>
<b>JDBS1-HD</b>	Lo-Back Bale Spear - Single 49"	3,500 lbs.	JD	189 lbs.	<b>\$880</b>	<b>5</b>
<b>LOADER MOUNT - DOUBLE SPEAR</b>						
<b>BS2-HD</b>	Lo-Back Bale Spear - Double 49"	3,500 lbs.	Uni. Skid Steer	233 lbs.	<b>\$895</b>	<b>5</b>
<b>EGBS2-HD</b>	Lo-Back Bale Spear - Double 49"	3,500 lbs.	Euro/Global	233 lbs.	<b>\$1,010</b>	<b>5</b>
<b>JDBS2-HD</b>	Lo-Back Bale Spear - Double 49"	3,500 lbs.	JD	233 lbs.	<b>\$1,010</b>	<b>5</b>
<b>LOADER MOUNT - TRIPLE SPEAR</b>						
<b>BS3-HD</b>	Lo-Back Bale Spear - Triple 39"	3,500 lbs.	Uni. Skid Steer	291 lbs.	<b>\$925</b>	<b>5</b>
<b>EGBS3-HD</b>	Lo-Back Bale Spear - Triple 39"	3,500 lbs.	Euro/Global	291 lbs.	<b>\$1,040</b>	<b>5</b>
<b>JDBS3-HD</b>	Lo-Back Bale Spear - Triple 39"	3,500 lbs.	JD	291 lbs.	<b>\$1,040</b>	<b>5</b>

Prices and specifications subject to change without notice. Check discounts & availability before quoting.  
 Product Designs May Differ Slightly Than What Appears in the Photographs.

# BALE GRABBERS & UNWINDERS



## BALE GRABBERS

### **RBG Series - For Round Bales (opens 48" - 78")**

- ◇ Available with 1 or 2 Hyd. Cylinders
- ◇ Available in Universal Skid Steer or Euro/Global Mounts
- ◇ Circular Design Ensures Strong & Gentle Grip of Bale
- ◇ Loader Mount Legs Provide Easy Hook-Up/Disconnect
- ◇ Units Come Standard With Hydraulic Hoses -No Couplers



## **RBG SERIES**



### **SBG Series - For Square/Round Bales (opens 26"-80")**

- ◇ Comes Standard with 2 Hyd. Cylinders
- ◇ Available in Universal Skid Steer or Euro/Global Mounts
- ◇ Loader Mount Legs Provide Easy Hook-Up/Disconnect
- ◇ Units Come Standard With Hydraulic Hoses - No Couplers

## **SBG SERIES**

Model	Description	Capacity	Mount	Weight	List Price	Packed
<b>ROUND BALE GRABBER</b>						
RBG-101	Round Bale Grabber - 1 Cydr.	2,200 lbs.	Uni. Skid Steer	430 lbs.	<b>\$2,475</b>	<b>3</b>
RBG-102	Round Bale Grabber - 1 Cydr.	2,200 lbs.	Euro/Global	430 lbs.	<b>\$2,475</b>	<b>3</b>
RBG-201	Round Bale Grabber - 2 Cydr.	2,200 lbs.	Uni. Skid Steer	446 lbs.	<b>\$2,875</b>	<b>3</b>
RBG-202	Round Bale Grabber - 2 Cydr.	2,200 lbs.	Euro/Global	446 lbs.	<b>\$2,875</b>	<b>3</b>
<b>SQUARE BALE GRABBER</b>						
SBG-201	Square Bale Grabber - 2 Cydr.	2,200 lbs.	Uni. Skid Steer	661 lbs.	<b>\$2,475</b>	<b>1</b>
SBG-202	Square Bale Grabber - 2 Cydr.	2,200 lbs.	Euro/Global	661 lbs.	<b>\$2,475</b>	<b>1</b>



## RBU SERIES

- ◇ Hydraulic Bale Unwinder
- ◇ 3 Bale Spears
- ◇ 3 point and Universal Skid Steer mount
- ◇ 3 point and Euro Global Mount

Model	Description	Mount	Weight	List Price
<b>ROUND BALE UNWINDER</b>				
RBU-100	Round Bale Unwinder	Skid Steer & 3 pt.	353 lbs.	<b>\$3,320</b>
RBU-101	Round Bale Unwinder	Euro Global & 3 pt.	353 lbs.	<b>\$3,320</b>

## **RBU SERIES**



# BUCKETS



## COMPACT UTILITY BUCKET

- ◇ Great For Compact Tractors
- ◇ 19" High x 18" Deep
- ◇ 4" x 1/2" Cutting Edge
- ◇ Heavy, Durable Construction
- ◇ For units below 45 HP
- ◇ Standard Universal Skid Steer Mount
- ◇ Optional JD Mount
- ◇ Available Sizes: 48", 60" & 72"



## CUB SERIES

Model	Description	Struck Capacity	Mount	Weight	List Price
<b>COMPACT UTILITY BUCKET</b>					
<b>CUB48</b>	Compact Utility Buckets - 48"	.22 <sup>3</sup>	Universal Skid Steer	157 lbs.	<b>\$895</b>
<b>CUB60</b>	Compact Utility Buckets - 60"	.27 <sup>3</sup>	Universal Skid Steer	201 lbs.	<b>\$995</b>
<b>CUB72</b>	Compact Utility Buckets - 72"	.32 <sup>3</sup>	Universal Skid Steer	245 lbs.	<b>\$1,115</b>

## BEAST SERIES LB BUCKET

- ◇ Heavy Duty Long Bottom, Low Profile Bucket
- ◇ 4" x 4" Rectangular Tubing Frame
- ◇ A-36 Steel with 3/4" x 6" cutting edge
- ◇ 1/4" Wrap & 1/2" Wall
- ◇ 1/2" Wear Bars and Side Cutters
- ◇ 21 3/4" High x 37.9" Deep
- ◇ Weld-On & Bolt-On Teeth Available
- ◇ Heavy, Durable Construction
- ◇ Standard Universal Skid Steer Mount
- ◇ Available Sizes: 72", 78" & 84"



## BB SERIES

Model	Description	Struck Capacity	Mount	Weight	List Price
<b>BEAST SERIES</b>					
<b>BB72</b>	Beast Series – 72"	1.16 <sup>3</sup>	Universal Skid Steer	776 lbs.	<b>\$2,375</b>
<b>BB72T</b>	Beast Series – 72" w/ teeth	1.16 <sup>3</sup>	Universal Skid Steer	826 lbs.	<b>\$2,705</b>
<b>BB78</b>	Beast Series – 78"	1.23 <sup>3</sup>	Universal Skid Steer	815 lbs.	<b>\$2,675</b>
<b>BB78T</b>	Beast Series – 78" w/ teeth	1.23 <sup>3</sup>	Universal Skid Steer	865 lbs.	<b>\$2,880</b>
<b>BB84</b>	Beast Series – 84"	1.36 <sup>3</sup>	Universal Skid Steer	875 lbs.	<b>\$2,975</b>
<b>BB84T</b>	Beast Series – 84" w/ teeth	1.36 <sup>3</sup>	Universal Skid Steer	932 lbs.	<b>\$3,215</b>

### OPTIONAL

<b>EG</b>	Euro-Global Mount instead of Skid Steer Mount (factory welded)				<b>\$115</b>
<b>JD</b>	JD Mount instead of Skid Steer Mount (factory welded)				<b>\$115</b>
<b>BOSS2</b>	Optional Side Cutters—BEAST BUCKET (Set of 2)				<b>\$165</b>

Prices and specifications subject to change without notice. Check discounts & availability before quoting.  
 Product Designs May Differ Slightly Than What Appears in the Photographs.

# BUCKETS



## SERIOUS DUTY MATERIAL BUCKET

- ◇ Ideal For Litter, Snow, Manure and Other Large Volume/ Light Weight Materials (NOT for digging)
- ◇ A-36 Steel with 3/4" x 6" cutting edge
- ◇ 28" High x 36" Deep
- ◇ Weld-On & Bolt-On Teeth Available
- ◇ Heavy, Durable Construction Standard Universal Skid Steer Mount
- ◇ Optional JD or Euro/Global Mounts
- ◇ Available Sizes: 80", 90" & 96"



## XMB SERIES

Model	Description	Struck Capacity	Mount	Weight	List Price
<b>SERIOUS DUTY MATERIAL</b>					
<b>XMB80</b>	Serious Duty Material Bucket - 80"	1.21 <sup>3</sup>	Universal Skid Steer	710 lbs.	<b>\$1,940</b>
<b>XMB90</b>	Serious Duty Material Bucket - 90"	1.36 <sup>3</sup>	Universal Skid Steer	825 lbs.	<b>\$2,195</b>
<b>XMB96</b>	Serious Duty Material Bucket - 96"	1.45 <sup>3</sup>	Universal Skid Steer	920 lbs..	<b>\$2,315</b>

## LOW PROFILE BUCKET

- ◇ A-36 Steel with 3/4" x 6" cutting edge
- ◇ 3/16" Wrap & 1/2" Wall
- ◇ 21" High x 27.5" Deep
- ◇ Weld-On & Bolt-On Teeth Available
- ◇ Heavy, Durable Construction
- ◇ For units below 67 HP
- ◇ Standard Universal Skid Steer Mount
- ◇ Available Sizes: 60", 72", & 84"



## LP SERIES

Model	Description	Struck Capacity	Mount	Weight	List Price
<b>LOW PROFILE</b>					
<b>LP60</b>	Low Profile Bucket – 60"	0.37 <sup>3</sup>	Universal Skid Steer	307 lbs.	<b>\$1,235</b>
<b>LP66</b>	Low Profile Bucket – 66"	0.41 <sup>3</sup>	Universal Skid Steer	345 lbs.	<b>\$1,335</b>
<b>LP72</b>	Low Profile Bucket – 72"	0.45 <sup>3</sup>	Universal Skid Steer	369 lbs.	<b>\$1,435</b>
<b>LP84</b>	Low Profile Bucket – 84"	0.52 <sup>3</sup>	Universal Skid Steer	455 lbs.	<b>\$1,630</b>
<b>Prefix</b>	<b>OPTIONAL</b>				
<b>EG</b>	Euro-Global Mount instead of Skid Steer Mount (factory welded)				<b>\$115</b>
<b>JD</b>	JD Mount instead of Skid Steer Mount (factory welded)				<b>\$115</b>
<b>BOCE12</b>	Bolt on cutting edge for Buckets with Bolts (installed)				<b>\$495</b>

# BUCKETS



## LONG BOTTOM BUCKET

- ◇ Long Bottom, Low Profile Bucket
- ◇ A-36 Steel with 3/4" x 6" cutting edge
- ◇ 3/16" Wrap & 1/2" Wall
- ◇ 21" High x 33.5" Deep
- ◇ Weld-On & Bolt-On Teeth Available
- ◇ Heavy, Durable Construction
- ◇ For units below 67 HP
- ◇ Standard Universal Skid Steer Mount
- ◇ Available Sizes: 60", 72", & 84"



Model	Description	Struck Capacity	Mount	Weight	List Price
<b>LONG BOTTOM</b>					
<b>LB60</b>	Long Bottom Bucket - 60"	0.37 <sup>3</sup>	Universal Skid Steer	481 lbs.	<b>\$1,310</b>
<b>LB72</b>	Long Bottom Bucket - 72"	0.45 <sup>3</sup>	Universal Skid Steer	537 lbs.	<b>\$1,555</b>
<b>LB84</b>	Long Bottom Bucket - 84"	0.52 <sup>3</sup>	Universal Skid Steer	651 lbs.	<b>\$1,815</b>

## ROCK BUCKET

- ◇ 3/4" x 6" cutting edge
- ◇ 3/8" tines across bottom spaced 3" apart
- ◇ High Quality 1/2" A36 Steel
- ◇ Weld-On Teeth Optional
- ◇ Heavy, Durable Construction
- ◇ Standard Universal Skid Steer Mount
- ◇ Optional JD or Euro/Global Mounts
- ◇ Available Sizes: 60", 72", 84" & 96"



Model shown with optional teeth

Model	Description	Mount	Weight	List Price
<b>ROCK BUCKET</b>				
<b>RB60</b>	Rock Bucket – 60"	Universal Skid Steer	605 lbs.	<b>\$1,815</b>
<b>RB72</b>	Rock Bucket – 72"	Universal Skid Steer	720 lbs.	<b>\$2,025</b>
<b>RB84</b>	Rock Bucket – 84"	Universal Skid Steer	822 lbs.	<b>\$2,305</b>
<b>RB96</b>	Rock Bucket – 96"	Universal Skid Steer	942 lbs.	<b>\$2,595</b>

PREFIX	OPTIONAL	List Price
<b>EG</b>	<b>Euro-Global Mount</b> instead of Skid Steer Mount (factory welded)	<b>\$115</b>
<b>JD</b>	<b>JD Mount</b> instead of Skid Steer Mount (factory welded)	<b>\$115</b>

Prices and specifications subject to change without notice. Check discounts & availability before quoting.  
 Product Designs May Differ Slightly Than What Appears in the Photographs.

# ROCK GRAPPLE



## ROCK GRAPPLE

- ◇ 3/4" x 6" cutting edge
- ◇ 3/8" tines across bottom and 1/2" sides spaced 3" apart
- ◇ 1/2" top tines on grapple
- ◇ Twin Cylinders with 2" bore & 10" stroke
- ◇ High Quality 1/2" A36 Steel

- ◇ 1 1/4" pins with counter sunk grease fittings
- ◇ Weld-On Teeth Optional
- ◇ Heavy, Durable Construction
- ◇ Units Come Standard With Flat Faced Couplers & Hoses
- ◇ Standard Universal Skid Steer Mount
- ◇ Optional JD or Euro/Global Mounts
- ◇ Available Sizes: 60", 72", 84" & 96"



Model shown with optional teeth

Model	Description	Mount	Weight	List Price
<b>ROCK GRAPPLE</b>				
RG60	Rock Grapple – 60"	Universal Skid Steer	778 lbs.	<b>\$4,250</b>
RG60T	Rock Grapple – 60" w/ weld on teeth	Universal Skid Steer	818 lbs.	<b>\$4,365</b>
RG72	Rock Grapple – 72"	Universal Skid Steer	920 lbs.	<b>\$4,750</b>
RG72T	Rock Grapple – 72" w/ weld on teeth	Universal Skid Steer	960 lbs.	<b>\$4,995</b>
RG80	Rock Grapple – 80"	Universal Skid Steer	940 lbs.	<b>\$4,995</b>
RG80T	Rock Grapple – 80" w/ weld on teeth	Universal Skid Steer	1,000 lbs.	<b>\$5,295</b>
RG84	Rock Grapple – 84"	Universal Skid Steer	1,087lbs.	<b>\$5,085</b>
RG84T	Rock Grapple – 84" w/ weld on teeth	Universal Skid Steer	1,127 lbs.	<b>\$5,395</b>

PREFIX	OPTIONAL	List Price
EG	Euro-Global Mount instead of Skid Steer Mount (factory welded)	<b>\$115</b>
JD	JD Mount instead of Skid Steer Mount (factory welded)	<b>\$115</b>

# UTILITY ROOT GRAPPLES



Specially designed for tractors and utility work. Heavy built, but still light weight to not overpower your tractor lift capabilities. All Compact Root Grapples come standard with hoses and Pioneer Couplers. All Standard Duty Root Grapples come standard with hoses and Flat-Faced Couplers. Available in JD and Euro Mounts.

	COMPACT	STANDARD DUTY
HP Rating	Under 40	Under 50
Frame	3" x 3"	3" x 3"
Tines	3/8"	3/8"
Spacing	10"	9 1/4"
Max Opening	34"	35"
Depth	29"	35 1/2"
Height Closed	16"	15 1/2"
Cylinders	2" x 8"	2" x 10"
Widths	48" - 60" - 72"	60" - 66" - 72"



**CRG  
SERIES**



**SDRG200  
SERIES**

Model	Description	Mount	Weight	List Price	Packed (same size)
<b>SUB COMPACT ROOT GRAPPLE - TRACTOR LOADER USE ONLY</b>					
<b>SCRG48</b>	Sub Compact Root Grapple - Single Grapple - 48"	Uni. Skid Steer	250 lbs.	<b>\$1,760</b>	2
<b>COMPACT ROOT GRAPPLE - TRACTOR LOADER USE ONLY</b>					
<b>CRG48</b>	Compact Root Grapple - Single Grapple - 48"	Uni. Skid Steer	420 lbs.	<b>\$1,725</b>	2
<b>CRG60</b>	Compact Root Grapple - Double Grapple - 60"	Uni. Skid Steer	438 lbs.	<b>\$1,975</b>	2
<b>CRG66</b>	Compact Root Grapple - Double Grapple - 66"	Uni. Skid Steer	465 lbs.	<b>\$2,065</b>	2
<b>CRG72</b>	Compact Root Grapple - Double Grapple - 72"	Uni. Skid Steer	487 lbs.	<b>\$2,175</b>	2
<b>STANDARD DUTY ROOT GRAPPLE - TRACTOR LOADER USE ONLY</b>					
<b>SDRG260</b>	Standard Duty Root Grapple—Double Grapple—60"	Uni. Skid Steer	600 lbs.	<b>\$3,195</b>	2
<b>SDRG266</b>	Standard Duty Root Grapple—Double Grapple—66"	Uni. Skid Steer	625 lbs.	<b>\$3,265</b>	2
<b>SDRG272</b>	Standard Duty Root Grapple—Double Grapple—72"	Uni. Skid Steer	650 lbs.	<b>\$3,325</b>	2
<b>PREFIX</b>	<b>OPTIONAL</b>				
<b>JD</b>	JD Mount instead of Skid Steer Mount (factory welded)			<b>\$115</b>	

Prices and specifications subject to change without notice. Check discounts & availability before quoting.  
Product Designs May Differ Slightly Than What Appears in the Photographs.

# COMMERCIAL ROOT GRAPPLES



Heavy designed for higher HP tractors and skid steer for intense commercial applications. Commercial Root Grapples come standard with hoses and Flat Faced Couplers. Available in JD and Euro Mounts.

	HEAVY DUTY	SERIOUS DUTY
HP Rating	Under 65	65+
Frame	4" x 4"	4" x 4"
Tines	1/2"	1/2" Inside - 5/8" Outside
Spacing	9 1/2"	9"
Max Opening	34"	37"
Depth	34 1/2"	37 1/2"
Height Closed	17"	16 1/2"
Cylinders	2" x 10"	2" x 10"
Widths	72" - 80"	72" - 80"



Model	Description	Mount	Weight	List Price
<b>HEAVY DUTY ROOT GRAPPLE - TRACTOR LOADER OR SKID STEER USE</b>				
HDRG272	Heavy Duty Root Grapple – Double Grapple – 72"	Universal Skid Steer	749 lbs.	\$3,650
HDRG280	Heavy Duty Root Grapple – Double Grapple – 80"	Universal Skid Steer	769 lbs.	\$3,850
HDRG284	Heavy Duty Root Grapple – Double Grapple – 84"	Universal Skid Steer	825 lbs.	\$3,945
<b>SERIOUS DUTY ROOT GRAPPLE - TRACTOR LOADER OR SKID STEER USE</b>				
XRG72	Serious Duty Root Grapple - Double Grapple - 72"	Universal Skid Steer	930 lbs.	\$4,255
XRG80	Serious Duty Root Grapple - Double Grapple - 80"	Universal Skid Steer	960 lbs.	\$4,375
XRG84	Serious Duty Root Grapple - Double Grapple - 84"	Universal Skid Steer	1,010 lbs.	\$4,675
<b>PREFIX</b>	<b>OPTIONAL</b>			
EG	Euro-Global Mount instead of Skid Steer Mount (factory welded)			\$115
JD	JD Mount instead of Skid Steer Mount (factory welded)			\$115

# CLAW GRAPPLES



## CLAW GRAPPLE - AR400

- ◇ Made With 3/8" AR400 Steel
- ◇ Cylinder has 2" bore & 10" stroke
- ◇ Units Come Standard With Pioneer Couplers & Hoses
- ◇ Universal Skid Steer Mount & JD Mount
- ◇ Dual Cylinders
- ◇ 55" & 66" Working Widths
- ◇ **BUILT FOR SUB-COMPACT TRACTORS ONLY**



## STD DUTY CLAW GRAPPLE

- ◇ Cylinder has 2 1/2" bore & 8" stroke
- ◇ Units Come Standard With Pioneer Couplers & Hoses
- ◇ Universal Skid Steer Mount
- ◇ Dual Cylinders
- ◇ 60", 66" & 72" Working Widths

Model	Description	Width	Mount	Weight	List Price	Packed (same size)
<b>COMPACT CLAW GRAPPLE - AR 400 STEEL - UNDER 25 HP - TRACTOR LOADER USE ONLY</b>						
CCG55-AR	Compact Claw Grapple 55" with AR400 Steel	55"	Uni. Skid Steer	205 lbs.	<b>\$1,925</b>	2
JDCCG55-AR	Compact Claw Grapple 55" with AR400 Steel	55"	John Deere Mount	192 lbs.	<b>\$1,925</b>	2
CCG66-AR	Compact Claw Grapple 66" with AR400 Steel	66"	Uni. Skid Steer	220 lbs.	<b>\$2,075</b>	2
JDCCG66-AR	Compact Claw Grapple 66" with AR400 Steel	66"	John Deere Mount	210 lbs.	<b>\$2,075</b>	2
<b>STANDARD DUTY CLAW GRAPPLE UP TO 50 HP - TRACTOR LOADER USE ONLY</b>						
SDCG60	Standard Duty Claw Grapple 60"	60"	Uni. Skid Steer	367 lbs.	<b>\$2,025</b>	2
SDCG66	Standard Duty Claw Grapple 66"	66"	Uni. Skid Steer	387 lbs.	<b>\$2,125</b>	2
SDCG72	Standard Duty Claw Grapple 72"	72"	Uni. Skid Steer	407 lbs.	<b>\$2,225</b>	2

Prices and specifications subject to change without notice. Check discounts & availability before quoting.  
Product Designs May Differ Slightly Than What Appears in the Photographs.

# CLAW GRAPPLES



## HEAVY DUTY STANDING CLAW GRAPPLE

- ◇ Heavy Duty Construction - 1/2" A-36 Steel
- ◇ Cylinders have 2" bore & 10" stroke
- ◇ Opens 52" to grab big material and closes tight
- ◇ 1 1/4" pins with counter sunk grease fittings and bushings
- ◇ Gussets on front tips for extra protection
- ◇ 3" x 3" x 1/4" Heavy Duty tubing
- ◇ Units Come Standard With Flat Faced Couplers & Hoses
- ◇ Standard Universal Skid Steer Mount
- ◇ Optional JD or Euro/Global Mounts
- ◇ Available Sizes: 72", 78" & 84"

Model	Description	Mount	Weight	List Price
<b>HEAVY DUTY STANDING CLAW GRAPPLE</b>				
<b>HDCG72</b>	Heavy Duty Claw Grapple - 72"	Universal Skid Steer	1,033 lbs.	<b>\$4,385</b>
<b>HDCG78</b>	Heavy Duty Claw Grapple - 78"	Universal Skid Steer	1,120 lbs.	<b>\$4,570</b>
<b>HDCG84</b>	Heavy Duty Claw Grapple - 84"	Universal Skid Steer	1,205 lbs.	<b>\$4,905</b>
<b>Prefix</b>	<b>OPTIONAL</b>			
<b>EG</b>	Euro-Global Mount instead of Skid Steer Mount (factory welded)			<b>\$115</b>
<b>JD</b>	JD Mount instead of Skid Steer Mount (factory welded)			<b>\$115</b>



# MISC. GRAPPLES



## FORK GRAPPLE

- ◇ Great for the log industry - move and carry more than regular pallet forks
- ◇ Grapple consists of 2" bore and 10" stroke cylinder
- ◇ Units Come Standard With Flat Faced Couplers & Hoses
- ◇ 48" Forks with 4,200 lbs. capacity
- ◇ Standard Universal Skid Steer Mount
- ◇ Optional JD or Euro/Global Mounts



## GRAPPLE BUCKET

- ◇ Heavy Duty Construction - 1/4" A-36 Steel
- ◇ Cylinders have 2" bore & 10" stroke
- ◇ Heavy Duty Cylinder Covers
- ◇ 1 1/4" pins with counter sunk grease fittings and bushings
- ◇ Weld-On & Bolt-On Teeth Available
- ◇ Units Come Standard With Flat Faced Couplers & Hoses
- ◇ Standard Universal Skid Steer Mount
- ◇ Optional JD or Euro/Global Mounts
- ◇ Available Sizes: 60", 72", 84" & 96"

Model	Description	Mount	Weight	List Price
<b>FORK GRAPPLE</b>				
HFG48	Heavy Duty Fork Grapple - 48" Forks	Universal Skid Steer	715 lbs.	\$2,965
<b>GRAPPLE BUCKET</b>				
HDGB60	Heavy Duty Grapple Bucket - 60"	Universal Skid Steer	820 lbs.	\$3,995
HDGB72	Heavy Duty Grapple Bucket - 72"	Universal Skid Steer	907 lbs.	\$4,195
HDGB84	Heavy Duty Grapple Bucket - 84"	Universal Skid Steer	972 lbs.	\$4,485
HDGB96	Heavy Duty Grapple Bucket - 96"	Universal Skid Steer	1,081 lbs.	\$4,765
<b>Prefix</b>	<b>OPTIONAL</b>			
EG	Euro-Global Mount instead of Skid Steer Mount (factory welded)			\$115
JD	JD Mount instead of Skid Steer Mount (factory welded)			\$115
BOCE12	Bolt on cutting edge for Buckets with Bolts (installed)			\$495

Prices and specifications subject to change without notice. Check discounts & availability before quoting.  
 Product Designs May Differ Slightly Than What Appears in the Photographs.

# VIBRATORY POST DRIVER



Tar River Manufacturing Post Drivers are designed to efficiently drive posts and break concrete on your skid steer. The vibratory action makes quick work driving posts into the ground. Both models come with a 8” post pad.

The action of the “jackhammer” drive allows you to drive posts with minimal post splitting common on typical drivers. The cup design of the post pad keeps the post positioned and allows it to be pulled or pushed straight if it begins to angle off course while being driven.



Model	Description	Ft. lbs. Energy	GPM	Post Pad Size	Mount	Weight	List Price
<b>VIBRATORY POST DRIVER</b>							
PD-68-200	Post Driver	750 lbs.	10.5-19	8”	Uni. Skid Steer	1,200 lbs.	<b>\$5,315</b>
PD-75-240	Post Driver	1,000 lbs.	13-24	8”	Uni. Skid Steer	1,650 lbs.	<b>\$6,255</b>

# LAND PLANE



Grade your land professionally with the Tar River land plane.

Built with heavy steel, this leveler will make short work of your grading needs on your farm, construction site or driveway.

Available in 6 and 8 foot working widths, the TRLP is the ideal tool for tackling many landscaping jobs.



Model	Description	Mount	Weight	List Price
TRLP72	72" Land Plane	Universal Skid Steer	209 lbs.	\$1,470
TRLP84	84" Land Plane	Universal Skid Steer	243 lbs.	\$1,795

# HEAVY DUTY BRUSH CUTTER



## TRBC60



Low profile blade assembly with Anti-wrapping rotor protection gives superior strength than with traditional designs

### HEAVY DUTY BRUSH CUTTER

- ◇ Low-Flow Cutter (14/23)
  - ◇ Open-Faced, Heavy Duty Deck made with 1/4" A36 Steel
  - ◇ 5" Cutting Capacity
  - ◇ Hydraulic Direct Drives & Internal Relief Valve
  - ◇ Bi-Directional Cutting
  - ◇ 3 Cutting Blades (AR-500 steel)
  - ◇ Units Come Standard With Flat Faced Couplers & Hoses
  - ◇ Standard Universal Skid Steer Mount
- RECOMMENDED: FLOW 16-20 GPM DO NOT EXCEED 23 GPM**

Model	Description	Cutting Capacity	Flow	Mount	Weight	List Price
<b>HEAVY DUTY</b>						
TRBC60	5 Foot Heavy Duty Brush Cutter	5"	14-20 gpm	Uni. Skid Steer	1074 lbs.	<b>\$7,440</b>
TRBC70	6 Foot Heavy Duty Brush Cutter	6"	14-20 gpm	Uni. Skid Steer	1530 lbs.	<b>\$7,995</b>

# SERIOUS DUTY BRUSH CUTTER



## SERIOUS DUTY BRUSH CUTTER

- ◇ Low-Flow Cutter (16/25)
  - ◇ Open Faced, Heavy Duty Deck made with 1/4" A36 Steel
  - ◇ 6" Cutting Capacity
  - ◇ Hydraulic Direct Drives & Internal Relief Valve
  - ◇ Bi-Directional Cutting
  - ◇ Extreme Blade Pan That is Extra Large To Maintain Force & Momentum
  - ◇ 2 Cutting Blades (AR-500)
  - ◇ Units Come Standard With Flat Faced Couplers & Hoses
  - ◇ Standard Universal Skid Steer Mount
  - ◇ Optional JD or Euro/Global Mounts
  - ◇ Available Sizes: 60" & 72"
- RECOMMENDED: FLOW 16-25 GPM DO NOT EXCEED 28 GPM**  
**CALL FOR HIGH FLOW OPTIONS**

Model	Description	Mount	Weight	List Price
<b>SERIOUS DUTY</b>				
XBC60	Serious Duty Brush Cutter - Low-Flow - 60"	Uni. Skid Steer	1,300 lbs.	\$8,050
XBC72	Serious Duty Brush Cutter - Low-Flow - 72"	Uni. Skid Steer	1,802 lbs.	\$8,850
<b>PREFIX</b>	<b>OPTIONAL</b>			
EG	Euro-Global Mount instead of Skid Steer Mount (factory welded)			\$115
JD	JD Mount instead of Skid Steer Mount (factory welded)			\$115

# HD STUMP BUCKETS & GRAPPLES



## HEAVY DUTY STUMP BUCKET

- ◇ Angled toward the front to keep the dirt from “sticking” inside the bucket
- ◇ Extra Bracing on the Back and Sides of the Bucket
- ◇ 3 Large Pin-On Teeth (Side Pin)
- ◇ 28" Wide across the Back
- ◇ 14" Wide across the Front
- ◇ 33.5" Deep
- ◇ 3/4" x 6" Cutting Edge Standard Universal Skid Steer Mount
- ◇ Optional JD or Euro/Global Mounts



## HEAVY DUTY STUMP BUCKET GRAPPLE

- ◇ 23" High x 24" Wide
- ◇ 4 Large Pin-on Teeth
- ◇ 3" x 3" Square Tubing
- ◇ 3/4" x 6" Cutting Edge
- ◇ 1/2" Gussets all around for added strength and durability
- ◇ Protection plates on top and front of grapple
- ◇ Grapple opens to 37"
- ◇ 1 1/4" Pins and bushings
- ◇ Counter-sunk grease fittings
- ◇ Units Come Standard With Flat Faced Couplers & Hoses
- ◇ Standard Universal Skid Steer Mount
- ◇ Optional JD or Euro/Global Mounts

Model	Description	Mount	Weight	List Price
<b>STUMP BUCKET</b>				
SB100	Heavy Duty Stump Bucket	Universal Skid Steer	310 lbs.	<b>\$1,135</b>
<b>STUMP BUCKET GRAPPLE</b>				
SBG100	Heavy Duty Stump Grapple	Universal Skid Steer	402 lbs.	<b>\$1,895</b>
<b>Prefix</b>	<b>OPTIONAL</b>			
EG	Euro-Global Mount instead of Skid Steer Mount (factory welded)			<b>\$115</b>
JD	JD Mount instead of Skid Steer Mount (factory welded)			<b>\$115</b>

# SD STUMP BUCKETS & GRAPPLES



## SERIOUS DUTY STUMP BUCKET

- ◇ Built from 4" x 4" x 1/4" Square Tubing
- ◇ 1/2" High Quality Steel on Sides, Bottom & Back
- ◇ 5 ft. 7 inches Deep
- ◇ 14" Wide across front
- ◇ 20" Wide across back
- ◇ 3 large replaceable cast teeth
- ◇ Serrated sides to help break loose roots and other debris
- ◇ 1" x 8" cutting edge
- ◇ Standard Universal Skid Steer Mount
- ◇ Optional JD or Euro/Global Mounts



## SB200 SERIES



## SERIOUS DUTY STUMP BUCKET GRAPPLE

- ◇ Built from 4" x 4" x 1/4" Square Tubing
- ◇ 1/2" High Quality Steel on Sides, Bottom & Back
- ◇ 5 ft. 7 inches Deep
- ◇ 14" Wide across front
- ◇ 20" Wide across back
- ◇ 3 large replaceable cast teeth
- ◇ Serrated sides to help break loose roots and other debris
- ◇ 1" x 8" cutting edge
- ◇ Grapple Opens 37"
- ◇ 1/2" Gussets All Around for Added Strength & Durability
- ◇ Protection Plates on Top & Front of Grapple
- ◇ Units Come Standard With Flat Faced Couplers & Hoses
- ◇ Standard Universal Skid Steer Mount
- ◇ Optional JD or Euro/Global Mounts

Model	Description	Mount	Weight	List Price
<b>STUMP BUCKET</b>				
SB200	Serious Duty Stump Bucket	Universal Skid Steer	625 lbs.	<b>\$1,545</b>
<b>STUMP BUCKET GRAPPLE</b>				
SBG200	Serious Duty Stump Grapple	Universal Skid Steer	733 lbs.	<b>\$2,455</b>
<b>Prefix</b>	<b>OPTIONAL</b>			
EG	Euro-Global Mount instead of Skid Steer Mount (factory welded)			<b>\$115</b>
JD	JD Mount instead of Skid Steer Mount (factory welded)			<b>\$115</b>

Prices and specifications subject to change without notice. Check discounts & availability before quoting.  
Product Designs May Differ Slightly Than What Appears in the Photographs.

# SNOW REMOVAL



## COMPACT SNOW BLADE

- ◇ Standard Universal Skid Steer Mount
- ◇ Reversible & Replaceable Rubber Edge
- ◇ Hydraulic Angle Left or Right
- ◇ Spring Loaded & Automatic Trip
- ◇ Available Sizes: 60", 72", 84" & 96"

**ORDER BLADE AND DESIRED EDGE KIT.**



Model	Description	Mount	Weight lbs.	List Price	Packed
<b>SNOW BLADE WITHOUT EDGE</b>					
CSP60NE	Compact Snow Blade 60"	Uni. Skid Steer Hitch	517	\$1,755	1
CSP72NE	Compact Snow Blade 72"	Uni. Skid Steer Hitch	537	\$1,865	1
CSP84NE	Compact Snow Blade 84"	Uni. Skid Steer Hitch	556	\$1,970	1
CSP96NE	Compact Snow Blade 96"	Uni. Skid Steer Hitch	587	\$2,185	1
JDCSP60NE	Compact Snow Blade 60"	JD Hitch	517	\$1,755	1
JDCSP72NE	Compact Snow Blade 72"	JD Hitch	537	\$1,865	1
JDCSP84NE	Compact Snow Blade 84"	JD Hitch	556	\$1,970	1
JDCSP96NE	Compact Snow Blade 96"	JD Hitch	587	\$2,185	1
<b>RUBBER EDGE</b>					
CSP60RE	60" Rubber Edge kit			\$175	
CSP72RE	72" Rubber Edge kit			\$200	
CSP84RE	84" Rubber Edge kit			\$225	
CSP96RE	96" Rubber Edge kit			\$250	
<b>STEEL EDGE</b>					
CSP60SE	60" Steel Edge kit			\$125	
CSP72SE	72" Steel Edge kit			\$140	
CSP84SE	84" Steel Edge kit			\$155	
CSP96SE	96" Steel Edge kit			\$170	
<b>PREFIX</b>	<b>OPTIONAL EQUIPMENT</b>				
CSP-HYD	Hydraulic angling Kit for CPS Model			\$515	



# SNOW REMOVAL



## SERIOUS DUTY SNOW PUSHER

- ◇ Serious Duty Construction makes this a great tool for Snow as well as Manure, etc.
- ◇ Rubber Edges come standard
- ◇ Available Sizes: 84", 96" & 120"
- ◇ Standard Universal Skid Steer Mount
- ◇ Optional JD or Euro/Global Mounts



## SERIOUS DUTY SNOW BLADE

- ◇ Reversible & Replaceable 8" x 1/2" Steel Cutting Edge
- ◇ Optional Rubber Edge - 6" x 1" (reversible)
- ◇ Adjustable Blade Height
- ◇ Hydraulic Angle Left or Right - 2" x 8" tie-rod cylinder
- ◇ Spring Loaded & Automatic Trip
- ◇ 3" x 3" x 1/4" solid backing across blade for protection and durability
- ◇ 5 1/2" thick back braces
- ◇ Standard Universal Skid Steer Mount
- ◇ Optional JD or Euro/Global Mounts
- ◇ Available Sizes: 72", 84", 96" & 108"

Model	Description	Mount	Weight	List Price
<b>SNOW PUSHER</b>				
XSP84	Serious Duty Snow Pusher - 84"	Universal Skid Steer	835 lbs.	<b>\$3,565</b>
XSP96	Serious Duty Snow Pusher - 96"	Universal Skid Steer	895 lbs.	<b>\$3,845</b>
XSP120	Serious Duty Snow Pusher - 120"	Universal Skid Steer	1,115 lbs.	<b>\$4,595</b>
<b>SERIOUS DUTY SNOW BLADE</b>				
SP72	Serious Duty Snow Plow - 72"	Universal Skid Steer	820 lbs.	<b>\$3,515</b>
SP84	Serious Duty Snow Plow - 84"	Universal Skid Steer	845 lbs.	<b>\$3,645</b>
SP96	Serious Duty Snow Plow - 96"	Universal Skid Steer	896 lbs.	<b>\$3,775</b>
SP108	Serious Duty Snow Plow - 108"	Universal Skid Steer	948 lbs.	<b>\$3,995</b>
Prefix	<b>OPTIONAL</b>			
EG	Euro-Global Mount instead of Skid Steer Mount (factory welded)			<b>\$115</b>
JD	JD Mount instead of Skid Steer Mount (factory welded)			<b>\$115</b>
RE12	Rubber Edge for Snow Plows (priced per foot)			<b>\$55/ft.</b>

# MISCELLANEOUS



## BOLT-ON TOOTH BARS

- ◇ Convert a Smooth Edge Bucket into a Tooth Bucket
- ◇ Achieve Better Digging Power
- ◇ 1/2" x 4" Cutting Edge
- ◇ Large Pin-On Teeth (Side Pin)
- ◇ 2 Pieces of 3" Square 3/8" Thick, Pre-Drilled Steel Comes with Every Tooth Bar
- ◇ Various Size Available Upon Request - Priced Per Foot, Round Up to Nearest Foot



## BOTB SERIES



## QA SERIES

## QUICK ATTACH PLATES

- ◇ Weld-On Universal Skid Steer Plates
- ◇ Available in 3 Thicknesses:
- ◇ Standard Duty - 1/4"
- ◇ Heavy Duty - 3/8"
- ◇ Serious Duty - 1/2"

## ADAPTER BRACKETS

- ◇ **EG2SS** – Adapts Euro/Global loader mounts to universal Skid Steer mount
- ◇ **JD2SS** – Adapts JD loader mounts to universal Skid Steer mount
- ◇ **BA2SS** – Blank Adaptor to universal Skid Steer



Model	Description	List Price
<b>TOOTH BARS (OTHER SIZES AVAILABLE UPON REQUEST)</b>		
<b>BOTB60</b>	Bolt-On Tooth Bar - 60"	<b>\$560</b>
<b>BOTB72</b>	Bolt-On Tooth Bar - 72"	<b>\$620</b>
<b>BOTB84</b>	Bolt-On Tooth Bar - 84"	<b>\$760</b>
<b>QUICK ATTACH PLATES</b>		
<b>SSQA14</b>	Standard Duty Quick-Attach Plate - 1/4"	<b>\$270</b>
<b>SSQA38</b>	Heavy Duty Quick-Attach Plate - 3/8"	<b>\$340</b>
<b>SSQA12</b>	Serious Duty Quick-Attach Plate - 1/2"	<b>\$420</b>
<b>ADAPTER BRACKETS</b>		
<b>EG2SS</b>	Euro/Global to Universal Skid Steer	<b>\$575</b>
<b>JD2SS</b>	John Deere to Universal Skid Steer	<b>\$575</b>
<b>BA2SS</b>	Blank Plate to Universal Skid Steer	<b>\$575</b>

# MISCELLANEOUS



## MANURE FORKS

- ◇ Replaceable Tines
- ◇ Standard Universal Skid Steer Mount
- ◇ Optional JD or Euro/Global Mounts



## TRAILER MOVER

- ◇ Great For Moving Gooseneck or Tow-Behind Trailers Around
- ◇ Standard Universal Skid Steer Mount

Model	Description	Mount	Weight	List Price
<b>TRAILER MOVER</b>				
<b>XTM1</b>	Trailer Mover	Universal Skid Steer	45 lbs.	<b>\$595</b>
<b>XTM2</b>	Trailer Mover w/ Ball	Universal Skid Steer	134 lbs.	<b>\$650</b>
<b>MANURE FORK</b>				
<b>MF60</b>	Manure Fork - 60"	Universal Skid Steer	391 lbs.	<b>\$1,705</b>
<b>MF72</b>	Manure Fork - 72"	Universal Skid Steer	445 lbs.	<b>\$1,965</b>
<b>PREFIX</b>	<b>OPTIONAL</b>			
<b>EG</b>	Euro-Global Mount instead of Skid Steer Mount (factory welded)			<b>\$115</b>
<b>JD</b>	JD Mount instead of Skid Steer Mount (factory welded)			<b>\$115</b>

# MINI SKID-STEER ATTACHMENTS



## TRMPF



## TRMRTG44

Model	Description	Misc. Info	Mount	Weight	List Price
<b>PALLET FORKS</b>					
TRMPF36	Pallet Forks – 36”	900# Capacity	Mini Skid Steer	251 lbs.	\$685
TRMPF42	Pallet Forks – 42”	900# Capacity	Mini Skid Steer	261 lbs.	\$705
<b>GRAPPLES</b>					
TRMRTG44	Root Grapple – 44”	Pioneer Fittings	Mini Skid Steer	362 lbs.	\$1,405

# MINI SKID-STEER ATTACHMENTS



**TRMLP44**

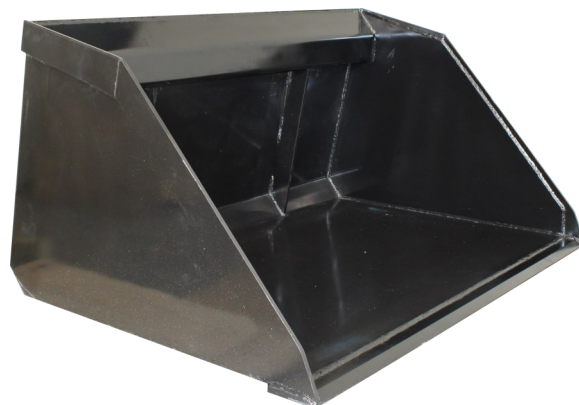

**TRMMB48**



**TRMBC**

Model	Description	Misc. Info	Mount	Weight	List Price
<b>BUCKETS</b>					
TRMLP44	Low Pro Bucket – 44”	.22 <sup>3</sup>	Mini Skid Steer	283 lbs.	\$625
TRMLPT44	Low Pro Bucket w/ Teeth – 44”	.22 <sup>3</sup>	Mini Skid Steer	303 lbs.	\$795
TRMMB48	Mini Material Bucket – 48”	.34 <sup>3</sup>	Mini Skid Steer	335 lbs.	\$715
<b>BRUSH CUTTER</b>					
TRMBC	Brush Cutter 44”	14-25 GPM, Pioneer Fittings 4” cut capacity	Mini Skid Steer	643 lbs.	\$5,295

# LIFT-SAFE IMPLEMENT HANDLER

Put down the chains and make moving and loading equipment a SAFE one-man job.



Belco Resources Equipment's Implement Handler was developed to make moving three point implements simple and worry free. The days of using chains and two people just to move a single rotary cutter, rear blade, landscape rake, etc. are over!



**Run Forks In**



**Lift to Hook**



**Lower to Load**

**Specifications:**

- ◇ Fits most three point implements
- ◇ Lift Capacity 2,000 lbs.
- ◇ Weight 241 lbs.

Model	Lift Capacity	Hitch	Weight	List Price
GSC-002	2,000	Cat 0, 1, 2 & 3	241	\$795

# REPLACEMENT TWINE & WRAP



Model	Description	List Price
TG0800	Replacement 8500' Twine — <i>for use with SRB-870</i>	\$25 (Parts Discount)
SRBW006	Replacement 26" x 5000' Net Wrap Roll — <i>for use with SRB-870NW</i>	\$125 (Parts Discount)
SRBW007	48" x 9843' Net Wrap Roll	\$260 (Parts Discount)
EW35000	30" x 5000' Silage Wrap Replacement — <i>for use with EW-450, EW-1800TA, &amp; BW 100 EVO</i>	\$125 (Parts Discount)

# RATCHET STRAPS



**Flat Hook**

Part #: 80006A-2



**Wire "J" Hook**

Part #: 80006A



**DEALER NET**

**\$13.99**

each\*

**Specifications:**

- ◇ 2" x 27'
- ◇ 10,000 lbs. capacity
- ◇ Available in Flat or Wire "J" Hooks
- ◇ Sold in boxes of 10\* (no mixing)



# LIMITED WARRANTY



Belco Resources Equipment warrants to the original purchaser of any new piece of machinery from Belco Resources Equipment, purchased from an authorized Belco Resources Equipment dealer, that the equipment be free from defects in material and workmanship for a period of one (1) year for non-commercial, state, and municipalities' use, ninety (90) days for commercial use from date of retail sale. The warranty for rental purposes is thirty (30) days. The obligation of Belco Resources Equipment to the purchaser under this warranty is limited to the repair or replacement of defective parts.

Replacement or repair parts installed in the equipment covered by this limited warranty are warranted for ninety (90) days from the date of purchase of such part or to the expiration of the applicable new equipment warranty period, whichever occurs later. Warranted parts shall be provided at no cost to the user at an authorized Belco Resources Equipment dealer during regular working hours. Belco Resources Equipment reserves the right to inspect any equipment or parts which are claimed to have been defective in material or workmanship.

This limited warranty does not apply to and excludes wear items such as shear pins, tires, tubes knives, blades, or other wear items. Oil or grease is not covered by this warranty.

All obligations of Belco Resources Equipment under this limited warranty shall be terminated if:

- Proper service is not performed on the machine.
- The machine is modified or altered in any way.
- The machine is being used or has been used for purposes other than those for which the machine was intended.

## DISCLAIMER OF IMPLIED WARRANTIES & CONSEQUENTIAL DAMAGES

Belco Resources Equipment obligation under this limited warranty, to the extent allowed by law, is in lieu of all warranties, implied or expressed, including implied warranties of merchantability and fitness for a particular purpose and any liability for incidental and consequential damages with respect to the sale or use of the items warranted. Such incidental and consequential damages shall include but not be limited to: transportation charges other than normal freight charges; cost of installation other than cost approved by Belco Resources Equipment; duty; taxes; charges for normal service or adjustment; loss of crops or any other loss of income; rental of substitute equipment, expenses due to loss, damage, detention or delay in the delivery.

## REGISTRATION

The online Warranty Registration must be completed in order to qualify for coverage on this Limited Warranty. Visit [www.BR-Equipment.com](http://www.BR-Equipment.com), click on "Warranty Registration" and completely fill out the form to register the new piece of equipment.

## EXTENDED WARRANTY

A two (2) or four (4) extended Gearbox Limited Warranty is provided for certain models at the end of the standard one (1) year warranty period. Extended Warranty does not cover labor or freight.

## ITEMS NOT COVERED

1. Owner Responsibility Parts: Some items must be serviced

and/or replaced because of normal machine usage. These are defined as "OWNER RESPONSIBILITY" items.

- "V" Belts – "V" belt service life varies due to application and conditions, such as:

Sandy abrasive conditions, slippage, burning due to overloading, improper adjustment, and engagement, etc. Thus, the service of a "V" belt may be measured in days to years. "V" belt replacement is normally an owner's responsibility.

- **Ground engaging and Cutter Parts** – (including tines, mower blades, wear plates, guide wheels, etc.) These parts are subject to wear, abuse, and replacement. Service life of these parts can vary from hours to years. The replacement of this category of parts is the owner's expense.
- **Tires** – Tires are matched to the normal operation of the machine. Excessive road use, abrasive field conditions, obstacles, improper inflation, etc. will drastically effect service life. Therefore, repair or replacement of tires is the owner's expense.
- **PTO's** – PTO shafts are exposed to numerous conditions that the manufacturer has no control over. **From the startup of a new machine, it is critical that they be "sized" to the specific tractor that the machine is being attached to. This must be the responsibility of the owner, with the aid and advice of the dealer.** Many dealers take this responsibility as part of the sales process; however, the owner must be aware of this issue in switching implements between tractors. Proper angle of operation is as critical as "sizing". Improper alignment will quickly damage a PTO shaft. Running a PTO during a sharp turn can cause serious damage. Machine to tractor PTO shafts are an owner's responsibility and are not a warranty item.

2. Failure due to abusive usage, lack of maintenance or accident: All repairs are the owner's expense for failures resulting from abusive usage, lack of maintenance, and/or accident.
3. Failures due to unauthorized alteration of machine or installation of unauthorized attachments: The installation of unauthorized attachments or the unauthorized alteration of a machine may overload certain components and result in unexpected repairs or overhaul. Any failure from the above is at the owner's expense.
4. Tractor Loader Attachments designated in PriceBook as "Tractor Loader Only" WILL NOT qualify for warranty if used on a SKID STEER.





# LIMITED WARRANTY

Warranty terms and conditions according to the law in force, except different written agreement between the parties.

The warranty is limited to the free replacement of the parts that presented defects in materials or workmanship that make them unsuitable for their intended use.

The parts to repair or replace must be sent to the headquarters of the seller at the expense and risk of the purchaser; repaired and replaced parts will be delivered free of establishments selling, remaining packaging to the buyer, as well as the costs for the intervention.

The buyer loses the right to the warranty:

- If he does not observe the terms of payment;
- If the claimed defects are originated by the facts of the buyer, its employees or third parties in general, also in case of misuse;
- If first of complaint to the seller, the buyer directly or through third parties, worked on the parts under warranty;
- If he fails to perform to contractual services

No guarantee will be due in the event of defects arising from bad maintenance, negligence or incompetence in the use, modification or tampering performed by the purchaser as well as force majeure. Excluded are normal wear and normal wear and tear.

In none of the cases provided from this article the purchaser may demand the termination of the contract or damages, direct or indirect, of any nature.

Any dispute, subject to revocation, will have to be made to the seller in writing and with specific indication of the defects complained, within eight days of discovery.

## **3 YEARS WARRANTY ON CAST METAL PARTS.**

Warranty must be activated on our website [www.orsigroup.it](http://www.orsigroup.it) entering Customer Service/Warranty Registration and filling the related form.

The form must be completed in any its part within **15 days**. the date of delivery (it is valid the date of the bill). If we don't receive the Warranty Certificate **18 months** after the date of invoicing by Orsi Group, the warranty is deemed to have expired.

There is no warranty on parts chromed, painted, etc. or on products left outside and not well maintained and protected during the warranty period.



# LIMITED WARRANTY

S3 Delta Harrows Inc. warrants that all Equipment purchased from an authorized S3 Delta Harrows Inc. Dealer in the United States or Canada shall be free from defects in workmanship and materials for a period of two (2) years from the date of purchase (“Warranty Period”).

The Warranty described herein is provided by S3 Delta Harrows Inc. to the original purchaser of the Equipment from an authorized S3 Delta Harrows Inc. Dealer. The Warranty is transferable during the Warranty Period provided the authorized Dealer from which the Equipment was purchased is notified in writing within ten (10) days of the change in ownership, the transferee provides the Dealer proof of purchase from the original purchaser, and the transfer is approved by S3 Delta Harrows Inc..

S3 Delta Harrows Inc., at its option, will repair or replace any part covered by the Warranty in the previous section during the Warranty Period on the following conditions:

- (a) The End User shall notify the Dealer of the defect within thirty (30) days of failure;
- (b) The End User shall produce proof of purchase together with photographs or such other proof of failure as may be requested by S3 Delta Harrows Inc. or the Dealer;
- (c) Any Warranty repairs shall be performed by the authorized selling Dealer or other Dealer approved by S3 Delta Harrows Inc.; and
- (d) S3 Delta Harrows Inc. determines in its sole and absolute discretion that the defect or failure is covered by the Warranty.

Warranty repairs or replacement shall be free of charge to the End User for materials, labor and shipping in Year 1 of the Warranty Period. S3 Delta Harrows Inc. shall repair or replace any parts under Warranty in Year 2, but the End User shall be responsible for labor and shipping charges in Year 2.

## NOT COVERED BY WARRANTY

S3 Delta Harrows Inc. shall not be responsible for the repair or replacement of:

- (a) Defective parts or subassemblies incorporated in Equipment that are warranted under original manufacturing warranties from OEM or third party suppliers;
- (b) Equipment that has been altered or modified in any manner not approved or authorized by S3 Delta Harrows Inc.; or
- (c) Damage caused by normal wear and tear, lack of reasonable and proper maintenance, failure to follow operating instructions in the Operator’s Manual furnished with the Equipment, misuse or excessive use, or damage caused by accident, vandalism or Act of God

## CUSTOMER RESPONSIBILITIES

In order to benefit from the Warranty set out herein, the End User must:

- (a) Notify the Dealer of the defect within thirty (30) days of failure;
- (b) Produce proof of purchase together with photographs or such other proof of failure as may be requested by S3 Delta Harrows Inc. or the Dealer;
- (c) Retain the defective part or subassembly for a minimum of ninety (90) days following notification of failure to the Dealer and return the defective part or subassembly to the Dealer if so requested at any time during the ninety (90) day retention period. Failure to return the part or assembly to the Dealer within thirty (30) days of request by S3 Delta Harrows Inc. may result in disallowance of the Warranty claim (if no request for return of the defective part is made by S3 Delta Harrows Inc. within the ninety (90) day retention period, the End User may dispose of the defective part or sub-assembly).



# LIMITED WARRANTY

## WARRANTY AGREEMENT PROCEDURE

### Liability for Defects

ENOAGRICOLA ROSSI Srl, in its capacity of manufacturer of ENOROSSI Products shall be liable for any material and/or manufacturing defects or faults of the ENOROSSI Products according to the terms and conditions of this clause (hereinafter referred to as the "Warranty").

The Warranty is for a term not to exceed 12 (twelve) months from the date on which said products are delivered to the first end user.

The Warranty is limited to the parts of ENOROSSI Products manufactured by ENOROSSI (either directly or through other companies of the group to which it belongs).

1.1. Within the above stated time-limits, the Warranty shall apply according to the following limitations.

- i) The Warranty shall not apply if Distributor had failed to comply with its obligations provided for under this article, or if ENOROSSI Products have been used in any other way than those ones indicated in the instructions supplied by ENOROSSI or they have been repaired, assembled, dismantled or adjusted by unauthorized persons, or if the damage is due to the use of components manufactured by third parties and not approved by ENOROSSI, or due to the use of farming or non-farming equipment that was not connected correctly and in any case not approved previously by ENOROSSI, as well as in case such changes have been made without ENOROSSI's written approval.
- ii) The Warranty does not cover damages due to force majeure, to the use of lubricants which are not suitable for the purpose or in any case do not comply with the instructions and guidelines set forth in the "Manual for Use and Maintenance" of ENOROSSI Products; damages due to overloading are expressly excluded as well.
- iii) Any obligation of ENOROSSI under the Warranty shall in no case exceed the ex-works value of the material and therefore does not include labour cost, transfer or similar charges. Materials subject to usual wear and tear, pipes, filter parts, belts, etc., are not covered by the Warranty.

1.2. In any case, Distributor undertakes to supply to the Customer at least the same form of warranty as provided for hereunder, starting from the date of delivery of the ENOROSSI Products to the first end user, and this for the minimum period required by laws in force in the territory defined in the Agreement, without any further costs, expense or obligation of ENOROSSI than those ones defined above. Distributor shall remain liable for any warranty delivered to the Customer, irrespective of any expiration of the Warranty.

1.3. Prior to delivery to Customers, ENOROSSI Products shall be checked and tested (at Distributor's expenses) in order to eliminate possible inconveniences that might have occurred during transportation or shipment. By the time of delivery to Customers, ENOROSSI's instructions shall be given in detail and carefully to the Distributor with respect to maintenance and use of such ENOROSSI Products. The Distributor shall also, at its own expenses, carry out the first and second service to the first end user.

- 1) For each ENOROSSI Product, a REGISTRATION FORM Certificate shall be supplied by ENOROSSI (PDF) printed form (see Annex no. 1 RF).

Upon delivery of ENOROSSI to the Customers, the Distributor must shall:

- i) duly fill in the REGISTRATION FORM
- ii) print the duly filled REGISTRATION FORM, sign it and have it signed by the first end user as acceptance of ENOROSSI product and as acknowledgement of all use and maintenance instructions given to the first end user; sending a copy to : [service@enorossi.it](mailto:service@enorossi.it)
- iii) carefully keep the signed copy of the REGISTRATION FORM, for 5 (five) years

- 2) in case the ENOROSSI Products remaining unsold for more than 12 (twelve) months after the date of the invoice issued by ENOROSSI, prior to delivery to the first end user, the Distributor shall carry out a deeply Dedicated Pre Delivery Inspection.

1.4. All claims will be rejected unless all the complete documentation set (REGISTRATION FORM, WARRANTY CLAIM FORM, PICTURES) All repairs to ENOROSSI Products during the term of this Warranty shall be made at the care of Distributor, using the required original spare parts available in its warehouse. Should the necessary material be not available, the Distributor shall order the parts to ENOROSSI.

Spare parts shall be delivered and invoiced to Distributor by ENOROSSI. After having repaired ENOROSSI Products, the Distributor shall deliver to ENOROSSI, within 15 days from the date of the service, the ("WARRANTY CLAIM FORM"), supplied by ENOROSSI (PDF) printed form (see Annex no. 2 RG).

ENOROSSI may either accept or reject such Warranty claim, at its final judgment. The WARRANTY CLAIM FORM shall be filled in all parts; Distributor shall take care of describing all technical reasons and conditions of use that requested intervention under the Warranty.

Should the Claim be accepted by ENOROSSI, the latter shall inform the Distributor delivering a statement which will contain the outcome result, within 30 (thirty) days.

Defective material, object of any Warranty claim, shall remain at ENOROSSI's disposal since ENOROSSI may request, and, if necessary, such material shall be shipped to ENOROSSI plants for technical inspection. In such case, transportation costs shall be borne by ENOROSSI. Distributor may destroy the defective material, object of any claim, only upon receipt of ENOROSSI's written statement which contains the exit of the Warranty claim.

Parts replaced under the Warranty shall be reimbursed at the current gross price-list value in force at the date of the warranty request. The parts to replace will be invoiced to the Distributor at 45% (forty-five per cent) on the current gross price-list value in force at the date. If the parts are in stock by the Distributor, ENOROSSI will send the part in the next shipment (container or truck with other machines/parts in order).

The distributor will invoice to ENOROSSI the part(s) at the same value of the invoice issued by ENOROSSI, plus the expenses/taxes paid by the Distributor to their customs, the Distributor must show all the details of these expenses/taxes to ENOROSSI.

# BELC RESOURCES EQUIPMENT



*INCREASING AGRICULTURAL PRODUCTIVITY SINCE 1974!*

*DISTRIBUTED BY :*