



2025
PRODUCT
CATALOG



YOUR
SOURCE

FOR AGRICULTURAL &
INDUSTRIAL COMPONENTS



TABLE OF CONTENTS

FLUID COMPONENTS

Pressure Gauges
Stainless & Brass Fittings
Poly & Nylon Fittings
Stainless & Poly Ball Valves
Strainers & More...

6

SPRAYER ACCESSORIES

Sprayer Frames & Boom Kits
Spray Nozzles for Booms
Boomless Spray Nozzles
Everflo Diaphragm Pumps
Spot Spray Guns & More...

42

AGRICULTURAL PARTS

Hitch, Clevis, & Implement Pins
PTO Adapters
Stabilizer Arms
Stroke Control Segments
Securing Pins & More...

70

AUTOMOTIVE

Top & Side Wind Trailer Jacks
Heavy Duty Trailer Jacks
Trailer Winches
RV Pumps & Fittings
Jack Accessories & More...

78

PRESSURE WASHING & SOFT WASH

Water Brooms & Surface Cleaners
Spray Guns, Lances, Hoses, & Kits
QC, MEG, & Rotary Nozzles
Soft Wash Pumps & Units
Accessories & More...

84

POWER EQUIPMENT

Disinfectant Sprayer
Pressure Washers
Water Pumps
Trash Pumps
Power Generators

104

ABOUT US

Valley Industries, initially established as a distributor of pressure gauges and accessories, has undergone a transformative evolution, solidifying its position as a pioneering force within the agricultural, industrial, and retail sectors. Presently, Valley Industries stands as a prominent manufacturer and distributor, offering an expansive array of thousands of products across multiple categories and renowned brands, all recognized for their unwavering commitment to superior performance and quality standards.

CONTACT US TODAY

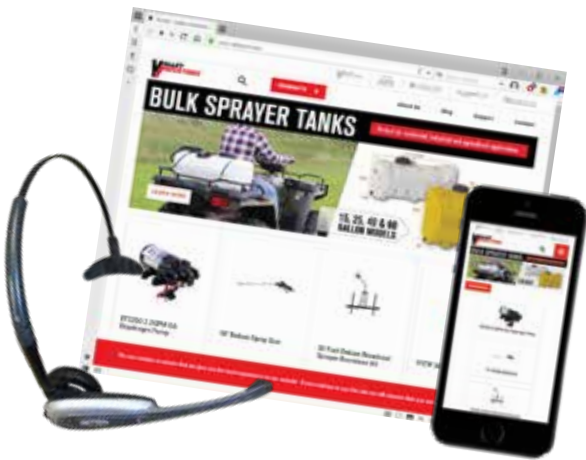

ORDERING

| | |
|--------|---------------------|
| Phone: | 800-864-1649 |
| Fax: | 888-708-1895 |
| Email: | sales@valleyind.com |

CUSTOMER SUPPORT

| | |
|--------|--------------------|
| Phone: | 800-825-5397 |
| Email: | info@valleyind.com |

OUR BRANDS



Agricultural Sprayers, Accessories & Components.
www.master-mfg.com



Diaphragm and High Pressure Plunger Pumps & Accessories.
www.cometpump.com



12 Volt DC Diaphragm Pumps & Accessories.
www.everflopump.com



Agricultural Mist Sprayers & Accessories.
www.mistsprayers.com



Professional Ag Sprayers, Attachments, & Accessories.
www.bestwayag.com

VALLEY INDUSTRIES ADVANTAGE

At Valley Industries, we are dedicated to exceeding our customers' expectations and consistently delivering quality products that precisely match their requirements. Our commitment to exceptional customer service is reflected in the meticulous engineering, assembly, and sourcing processes we employ, which incorporate top-notch components, all while ensuring competitive pricing for our valued customers.

ENGINEERING & MANUFACTURING



The Valley Industries team is continuously engaged in innovation, crafting fresh concepts and ideas that consistently deliver the expected quality and performance in every product.

CENTRALIZED LOCATION

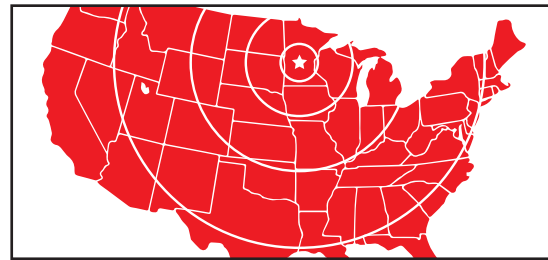

All of our facilities are based in Paynesville, MN, providing a quick turn-around on your orders.

BUNDLE UP



Save time, money, and resources by bundling with Valley Industries. With just one purchase order, bundle products from all available brands and categories.

360° CUSTOMER SERVICE



Valley Industries provides 360-degree visibility to all customers, big or small. Through trouble-shooting guides or an informed sales staff, effortlessly receive solutions to your problems.

MERCHANDISING

At Valley Industries, we're not content with the status quo. We have reimagined the way products are presented, packaged, and displayed, introducing innovative solutions that breathe new life into the retail experience. From our eye-catching packaging designs to strategic point-of-purchase placements and customizable pre-set planograms, we are committed to transforming the way products are showcased and sold, creating engaging and efficient retail environments that captivate customers and drive sales.

POINT OF PURCHASE



Our innovative point-of-purchase displays captivate shoppers, making their retail experience more engaging and convenient while driving increased sales and brand recognition.

PRE-SET PLANOGRAMS



Valley Industries' pre-set planograms prioritize high-velocity products, ensuring they follow a logical and visually appealing flow for an optimized shopping experience.

PACKAGING



Valley Industries' packaging goes beyond protection; it's designed to engage and inform customers, assisting them in making confident and informed purchasing choices.





RETAIL READY CLAMSHELL PACKAGING

VALLEY INDUSTRIES offers the option of high quality clamshell retail display packaging on select gauges.

Contact us for minimum quantities and availability!

Since 1998, Valley Industries has been a leading pressure gauge supplier world-wide. Today, we manufacture and distribute a wide range of industrial and agricultural products across several brands. Even with our expanded product offerings, we continue to keep focus on being the #1 pressure gauge source to our customers!

PRESSURE GAUGES CUSTOM LOGOS & DIALS

Use your company logo, trademarks and color schemes to tie your gauge to your brand or style.

Custom Gauge Faces

The highest level of customization from identification zones, numbering, scale colors and more to fit your needs.



Small Order Size

Minimum order quantity of only 100 pieces allows you to customize your gauges without forcing you to hold huge numbers in stock. No additional charge for artwork!

Short Lead Times

We provide digital files for your approval before going into production. Gauges are typically finished with 90-120 days from placement of your order.

Flexible Terms

A variety of payment terms are available to meet your needs. Talk to your sales representative today for more information.

PRESSURE GAUGES

SINGLE & DUAL SCALE 10 SERIES GEARLESS

| | |
|------------------------|--------------------------------------|
| Movement | None |
| Bourdon Tube | Copper alloy, spiral wound, gearless |
| Pointer | Brass |
| Dial | White aluminum |
| Window | Acrylic |
| Fill Material | Dry only |
| Connection Size | 1/8" MNPT |
| Accuracy | ASME/ANSI B40.1 Grade D (±5%) |

1, 1 1/4" Casing. Center Back Mount only. These gauges are designed for use on compressors, mini regulators and pneumatic applications where space is at a premium.



ORDERING INFORMATION

| Part # | PSI Range |
|----------------|-----------|
| 23MM0010DCB60 | 0 - 60 |
| 23MM0010DCB100 | 0 - 100 |
| 23MM0010DCB160 | 0 - 160 |

ORDERING INFORMATION

Non-Stock
Please Call for pricing and ordering information.

| | |
|----------------------------|---|
| Movement | Brass |
| Bourdon Tube | C-Shaped in copper alloy up to 600 PSI and Helical in phosphor bronze above 600 PSI |
| Pointer | Black enameled aluminum |
| Dial | White aluminum |
| Window | Acrylic |
| Case Material | Steel, black painted |
| Bezel | Chrome plated |
| Connection Material | Brass |
| Connection Size | 1/8" MNPT on 1 1/2" size. 1/4" MNPT on 2", 2 1/2" and 4" sizes. |
| Accuracy | ASME/ANSI B40.1 Grade B (3-2-3%) |
| Fill Material | Dry only |
| Wetted Parts | Copper alloy |

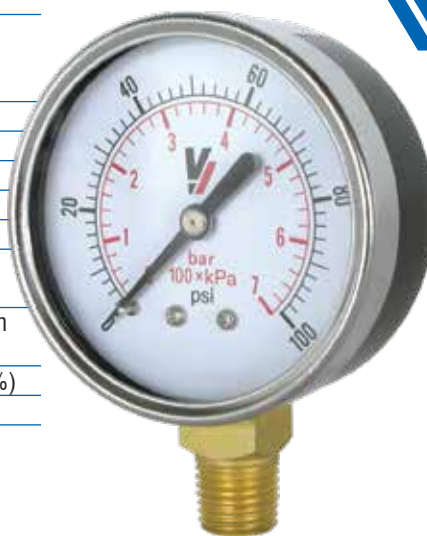

DUAL SCALE 20 SERIES GENERAL SERVICE

1 1/2", 2", 2 1/2", and 4" Casing
Center Back and Bottom Mount Only.

These gauges are designed for use with gas, oil, and water or any medium not corrosive to brass or bronze.

Temp Rating -40° F to 150° F

ORDERING INFORMATION

| 1 st Digit | 2 nd Digit | 3 rd , 4 th Digit | 5 th Digit | 6 th Digit | 7 th Digit | Range | Suffix |
|-----------------------|-----------------------|---|-----------------------|-----------------------|-----------------------|------------------|--------------|
| Dial Size | Case Style | Model # | Fill Material | Case Material | Wetted Parts | PSI/bar/Vacuum | Options |
| 0 = 1 1/2" | 1 = Bottom | 20 | D = Dry | S=Steel | B = Brass | Up to 1000 PSI | Custom Logo |
| 1 = 2" | 2 = Back | | | | | Up to 70 bar | Color Dial |
| 2 = 2 1/2" | | | | | | Vacuum Available | Special Dial |
| 4 = 4" | | | | | | | Etc.. |

1120DSB200 = 2" Bottom Mount, Model 20, Dry, Steel Case, 200 PSI

PRESSURE

SINGLE SCALE 24 SERIES GENERAL SERVICE

2", 2½", and 4" Casing
Bottom Mount Only.

These gauges are designed for use with gas, oil, and water or any medium not corrosive to brass or bronze.

Temp Rating -40° F to 150° F (Dry)



| | |
|----------------------------|---|
| Movement | Brass |
| Bourdon Tube | C-Shaped in copper alloy up to 600 PSI and Helical in phosphor bronze above 600 PSI |
| Pointer | Black enameled aluminum |
| Dial | White aluminum |
| Window | Acrylic |
| Case Material | ABS standard, black steel optional |
| Bezel | Black |
| Connection Material | Brass |
| Connection Size | ¼" MNPT |
| Accuracy | ASME/ANSI B40.1 Grade B (3-2-3%) |
| Fill Material | Dry only |
| Wetted Parts | Copper alloy |

ORDERING INFORMATION

| 1 st Digit | 2 nd Digit | 3 rd , 4 th Digit | 5 th Digit | 6 th Digit | 7 th Digit | Range | Suffix |
|-----------------------|-----------------------|---|-----------------------|-----------------------|-----------------------|---------------|--------------|
| Dial Size | Case Style | Model # | Fill Material | Case Material | Wetted Parts | PSI | Options |
| 0 = 1½" | 1 = Bottom | 24 | D = Dry | A = ABS | B = Brass | Up to 600 PSI | Custom Logo |
| 1 = 2" | | | | S = Black Steel* | | | Color Dial |
| 2 = 2½" | | | | | | | Special Dial |
| 4 = 4" | | | | | | | Etc. |

1124DSB200 = 2" Bottom Mount, Model 24, Dry, Steel Case, 200 PSI *Special Order.

| | |
|----------------------------|---|
| Movement | Brass |
| Bourdon Tube | C-Shaped in copper alloy up to 600 PSI and Helical in phosphor bronze above 600 PSI |
| Pointer | Black enameled aluminum |
| Dial | White aluminum |
| Window | Polycarbonate |
| Case Material | Steel, corrosion resistant black |
| Bezel | Stainless Steel Rolled |
| Connection Material | Brass |
| Connection Size | ½" MNPT on 1½" size. ¼" MNPT on 2" and 2½" sizes. |
| Accuracy | ASME/ANSI B40.1 Grade A (2-1-2%) |
| Fill Material | Dry only |
| Wetted Parts | Copper alloy |



DUAL SCALE 30 SERIES UTILITY

1½", 2", and 2½" Casing
Center Back, Bottom, Front,
or Panel Mount.

These gauges are designed for use with gas, oil, and water or any medium not corrosive to brass or bronze.

Temp Rating -40° F to 150° F (Dry)

ORDERING INFORMATION

| 1 st Digit | 2 nd Digit | 3 rd , 4 th Digit | 5 th Digit | 6 th Digit | 7 th Digit | Range | Suffix |
|-----------------------|-----------------------|---|-----------------------|-----------------------|-----------------------|------------------|--------------|
| Dial Size | Case Style | Model # | Fill Material | Case Material | Wetted Parts | PSI/bar/Vacuum | Options |
| 0 = 1½" | 1 = Bottom | 30 | D = Dry | S = Black Steel | B = Brass | Up to 6000 PSI | Custom Logo |
| 1 = 2" | 2 = Back | | | | | Up to 400 bar | Color Dial |
| 2 = 2½" | 3 = Front | | | | | Vacuum Available | Special Dial |
| | 4 = Panel | | | | | | Etc. |

1130DSB200 = 2" Bottom Mount, Model 30, Dry, Steel Case, 200 PSI

GAUGES



| | |
|----------------------------|---|
| Movement | Brass |
| Bourdon Tube | C-Shaped in copper alloy up to 600 PSI and Helical in phosphor bronze above 600 PSI |
| Pointer | Black enameled aluminum |
| Dial | White aluminum |
| Window | Polycarbonate - temperature compensating |
| Case Material | 304 Stainless steel |
| Connection Material | Brass |
| Connection Size | 1/8" MNPT on 1 1/2" size. 1/4" MNPT on 2", 2 1/2" and 4" sizes. |
| Accuracy | ASME/ANSI B40.1 Grade A (2-1-2%) |
| Fill Material | Dry, Glycerin, Silicone |
| Wetted Parts | Copper alloy |



DUAL SCALE 40 SERIES INDUSTRIAL

1 1/2", 2", 2 1/2", and 4" Casing
Center Back, Bottom, Front, or Panel Mount.

These gauges are designed for use with any medium not corrosive to brass or bronze.

| | |
|--------------------|---|
| Temp Rating | -50° F to 150° F (Silicone) -40° F to 150° F (Dry) 32° F to 150° F (Glycerin) |
|--------------------|---|

ORDERING INFORMATION

| 1 st Digit | 2 nd Digit | 3 rd , 4 th Digit | 5 th Digit | 6 th Digit | 7 th Digit | Range | Suffix |
|-----------------------|-----------------------|---|-----------------------|-----------------------|-----------------------|------------------|--------------|
| Dial Size | Case Style | Model # | Fill Material | Case Material | Wetted Parts | PSI/bar/Vacuum | Options |
| 0 = 1 1/2" | 1 = Bottom | 40 | D = Dry* | X=Stainless | B = Brass | Up to 10000 PSI | Custom Logo |
| 1 = 2" | 2 = Back | | G = Glycerin | | | Up to 700 bar | Color Dial |
| 2 = 2 1/2" | 3 = Front | | S = Silicone* | | | Vacuum Available | Special Dial |
| 4 = 4" | 4 = Panel | | | | | | Etc. |

1140GXB200 = 2" Bottom Mount, Model 40, Glycerin Filled, Stainless Steel Case, 200 PSI *Special Order.

SINGLE SCALE 41 SERIES OEM

2 1/2" and 4" Casing
Center Back, Bottom, Front, or Panel Mount.

These gauges are designed for use with any medium not corrosive to brass or bronze.



| | |
|----------------------------|---|
| Movement | Brass |
| Bourdon Tube | C-Shaped in copper alloy up to 1000 PSI and Helical in phosphor bronze above 1000 PSI |
| Pointer | Black enameled aluminum |
| Dial | White aluminum |
| Window | Acrylic |
| Case Material | 304 Stainless steel |
| Connection Material | Brass |
| Connection Size | 1/4" MNPT |
| Accuracy | ASME/ANSI B40.1 Grade B (3-2-3%) |
| Fill Material | Dry, Glycerin |
| Wetted Parts | Copper alloy |

| | |
|--------------------|--|
| Temp Rating | -40° F to 150° F (Dry) 32° F to 150° F (Glycerin) |
|--------------------|--|

ORDERING INFORMATION

| 1 st Digit | 2 nd Digit | 3 rd , 4 th Digit | 5 th Digit | 6 th Digit | 7 th Digit | Range | Suffix |
|-----------------------|-----------------------|---|-----------------------|-----------------------|-----------------------|------------------|--------------|
| Dial Size | Case Style | Model # | Fill Material | Case Material | Wetted Parts | PSI/Vacuum | Options |
| 2 = 2 1/2" | 1 = Bottom | 41 | D = Dry* | X=Stainless | B = Brass | Up to 10000 PSI | Custom Logo |
| | 2 = Back* | | G = Glycerin | | | Vacuum Available | Color Dial |
| | 3 = Front* | | | | | | Special Dial |
| | 4 = Panel* | | | | | | Etc. |

2141GXB200 = 2" Bottom Mount, Model 41, Glycerin Filled, Stainless Steel Case, 200 PSI *Special Order.



PRESSURE

SINGLE SCALE 54 SERIES STAINLESS OEM

2½" and 4" Casing
Center Back, Bottom, Front, or Panel
Mount.

These gauges are designed for use with any medium not corrosive to stainless steel.

Temp Rating -50° F to 150° F (Silicone)
-40° F to 150° F (Dry)
32° F to 150° F (Glycerin)



| | |
|----------------------------|------------------------------------|
| Movement | Stainless steel |
| Bourdon Tube | 316 Stainless steel |
| Pointer | Black enameled aluminum |
| Dial | White aluminum |
| Window | Polycarbonate |
| Case Material | 304 Stainless steel |
| Connection Material | 304 Stainless steel |
| Connection Size | ¼" MNPT |
| Accuracy | ASME/ANSI B40.1 Grade B (3-2-3%) |
| Fill Material | Dry, Glycerin, Silicone, Florolube |
| Wetted Parts | Stainless steel |

ORDERING INFORMATION

| 1 st Digit | 2 nd Digit | 3 rd , 4 th Digit | 5 th Digit | 6 th Digit | 7 th Digit | Range | Suffix |
|---|-----------------------|---|-----------------------|-----------------------|-----------------------|------------------|--------------|
| Dial Size | Case Style | Model # | Fill Material | Case Material | Wetted Parts | PSI/Vacuum | Options |
| 2 = 2½" | 1 = Bottom | 54 | D = Dry* | X=Stainless | X=Stainless | Up to 10000 PSI | Custom Logo |
| 4 = 4" | 2 = Back* | | G = Glycerin | | | Vacuum Available | Color Dial |
| | 3 = Front* | | S = Silicone* | | | | Special Dial |
| | 4 = Panel* | | F = Florolube* | | | | Etc. |
| 2154DXX200 = 2" Bottom Mount, Model 54, Dry, Stainless Steel Case, 200 PSI | | | | | | *Special Order. | |

| | |
|----------------------------|-------------------------------|
| Movement | Stainless steel |
| Bourdon Tube | 316 Stainless steel |
| Pointer | Black enameled aluminum |
| Dial | White aluminum |
| Window | Polycarbonate |
| Case Material | 304 Stainless steel |
| Bezel | Stainless steel, Bayonet type |
| Connection Material | 316 Stainless steel |
| Connection Size | ½" MNPT |
| Accuracy | ASME/ANSI B40.1 Grade 1A (1%) |
| Fill Material | Dry, Glycerin, Silicone |
| Wetted Parts | Stainless steel |



SINGLE SCALE 58 SERIES STAINLESS REPAIRABLE

4" Casing
Bottom Mount Only.

These gauges are designed for use with any medium not corrosive to stainless steel. Liquid-filled gauges are recommended for reducing shock caused by pressure fluctuations or vibration.

Temp Rating -50° F to 150° F (Silicone)
-40° F to 150° F (Dry)
32° F to 150° F (Glycerin)

ORDERING INFORMATION

| 1 st Digit | 2 nd Digit | 3 rd , 4 th Digit | 5 th Digit | 6 th Digit | 7 th Digit | Range | Suffix |
|---|-----------------------|---|-----------------------|-----------------------|-----------------------|------------------|--------------|
| Dial Size | Case Style | Model # | Fill Material | Case Material | Wetted Parts | PSI/Vacuum | Options |
| 4 = 4" | 1 = Bottom | 58 | D = Dry* | X=Stainless | X=Stainless | Up to 15000 PSI | Custom Logo |
| | | | G = Glycerin | | | Vacuum Available | Color Dial |
| | | | S = Silicone* | | | | Special Dial |
| | | | | | | | Etc. |
| 4158DXX200 = 4" Bottom Mount, Model 58, Stainless Dry, Steel Case, 200 PSI | | | | | | *Special Order. | |

GAUGES

60 SERIES LOW PRESSURE

2½" and 4" Casing
Bottom Mount Only.



These gauges are designed for use with any medium not corrosive to bronze or brass and pressures up to 10 psi.

Temp Rating -40° F to 150° F

| | |
|----------------------------|-------------------------------------|
| Movement | Brass |
| Diaphragm | Sensitive phosphor bronze |
| Pointer | Black enameled aluminum |
| Dial | White aluminum |
| Window | Acrylic |
| Case Material | Steel, black painted |
| Connection Material | Brass |
| Connection Size | ¼" MNPT |
| Accuracy | ASME/ANSI B40.1 Grade A (2-1-2%) |
| Fill Material | Dry only |
| Wetted Parts | Copper alloy |

ORDERING INFORMATION

| 1 st Digit | 2 nd Digit | 3 rd , 4 th Digit | 5 th Digit | 6 th Digit | 7 th Digit | Range | Suffix |
|-----------------------|-----------------------|---|-----------------------|-----------------------|-----------------------|-------------------------------|---|
| Dial Size | Case Style | Model # | Fill Material | Case Material | Wetted Parts | Inches of Water/PSI | Options |
| 2 = 2½" | 1 = Bottom | 60 | D = Dry | S=Steel | B = Brass | Up to 200 IOW Up to 10 PSI | Custom Logo Color Dial Special Dial Etc. |
| 4 = 4" | | | | | | | |

4160DSB015"H20 = 4" Bottom Mount, Model 60, Dry, Steel Case, 15 PSI

*Special Order.

80 SERIES AMMONIA

2½" and 4" Casing
Bottom Mount Only.

This rugged product employs a 316 stainless steel bourdon tube, ASME grade A movement, and a stainless steel socket all housed in a corrosive resistant painted steel case. This gauge is of the highest quality and is very competitively priced. In addition we will include your name and logo on the dial free of charge with a minimum order of 250 pieces per range. Also available with glass lense.



| | |
|----------------------------|-------------------------------------|
| Movement | 304 Stainless steel |
| Bourdon Tube | 316 Stainless steel |
| Pointer | Black enameled aluminum |
| Dial | White aluminum |
| Window | Acrylic |
| Case Material | Enameled steel |
| Connection Material | 304 Stainless steel |
| Connection Size | ¼" MNPT |
| Accuracy | ASME/ANSI B40.1 Grade A (2-1-2%) |
| Fill Material | Dry only |
| Wetted Parts | Stainless steel |

Temp Rating -40° F to 150° F

ORDERING INFORMATION

| 1 st Digit | 2 nd Digit | 3 rd , 4 th Digit | 5 th Digit | 6 th Digit | 7 th Digit | Range | Suffix |
|-----------------------|-----------------------|---|-----------------------|-----------------------|-----------------------|-----------------------------------|---|
| Dial Size | Case Style | Model # | Fill Material | Case Material | Wetted Parts | PSI/Vacuum | Options |
| 2 = 2½" | 1 = Bottom | 80 | D = Dry | S=Steel | X=Stainless | Up to 400 PSI Vacuum Available | Custom Logo Color Dial Special Dial Etc. |
| 4 = 4" | | | | | | | |

4180DSX160 = 4" Bottom Mount, Model 80, Dry, Steel Case, 160 PSI

*Special Order.

INDICATOR

GAUGE EDGE



FEATURES

| | |
|----------------------------|-------------------------------|
| Movement | Gearless |
| Bourbon Tube | C-Shaped copper alloy |
| Pointer | Red plastic |
| Dial | White plastic |
| Window | Acrylic |
| Case Material | Plastic |
| Connection Material | Brass |
| Connection Size | 10-32 Female thread |
| Accuracy | ASME/ANSI B40.1 Grade D (±5%) |
| PSI & bar. | Ranges 60PSI & 100 PSI |

½" x 2½" Case

Ideally suited for low-profile panels where space is at a premium. Designed for use with air, gas, light oil, water and any medium not corrosive to brass or bronze.

| Part# | PSI Range |
|----------|-----------|
| 00EDGE60 | 0 - 60 |

GAUGES INDICATOR



1HA7353



1K528E

| Part # | Size | Description |
|---------|------|---|
| 1HA7353 | 2" | Ammeter Gauge, Oliver Logo |
| 1K528E | 2" | Temperature Gauge, Oliver Logo, 52" Cap. Tube |

GAUGE TEMPERATURE



| Part # | Size |
|--------------|------|
| C3NN18287A-P | 2" |

Includes Bracket & Farrel

GAUGE OIL PRESSURE

Center Back Mount Only.



| Part # | Size | PSI | Connection Size |
|----------|------|------|-----------------|
| 70207834 | 2" | 0-30 | 1/8" MNPT |

GAUGES

GAUGE OIL PRESSURE



Center Back Mount Only.

| Part # | Size | PSI | Connection Size |
|---------|------|------|-----------------|
| 9N9273A | 2" | 0-50 | 1/8" MNPT |

GAUGE OIL PRESSURE



Center Back Mount Only.

| Part # | Size | PSI | Connection Size |
|----------|------|------|-----------------|
| FAD9273A | 2" | 0-80 | 1/8" MNPT |

GAUGE AMPERES



| Part # | Size | Range |
|------------|------|---------|
| A0NN10670A | 2" | 30-0-30 |

GAUGE AMPERES



| Part # | Size | Range |
|----------|------|---------|
| 70275840 | 2" | 20-0-20 |

GAUGE TEMPERATURE



| Part # | Size | Range |
|-----------------------------|------|-------------|
| UTG25 | 2" | 130°-280° F |
| Includes 70" Capillary Line | | |

GAUGE VOLTMETER

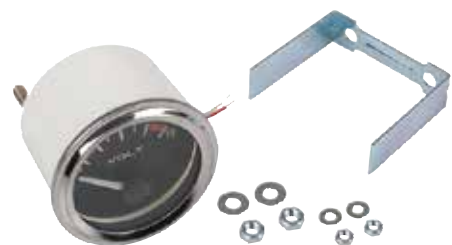

| Part # | Size | Range |
|----------|------|-------|
| VOLT12LT | 2" | 8-16V |



PRESSURE GAUGE ACCESSORIES

PROTECTIVE COVERS



| Part # | Size | Color |
|----------|--------|-------|
| 20RC-BLK | 2" | Black |
| 25RC-BLK | 2 1/2" | Black |
| 25RC-BL | 2 1/2" | Blue |

FRONT FLANGES



| Part # | Size | Gauge Series |
|------------|--------|--------------|
| 0330/40-FF | 1 1/2" | 30 / 40 / 41 |
| 1330/40-FF | 2" | 30 / 40 / 41 |
| 2330/40-FF | 2 1/2" | 30 / 40 / 41 |
| 4330/40-FF | 4" | 30 / 40 / 41 |

Push on Front Flange for panel mount gauge

ANSI STANDARD RINGS



| Part # | Size |
|--------------|--------|
| ANSI RING-20 | 2" |
| ANSI RING-25 | 2 1/2" |

Oversize polished stainless steel rings designed to allow DIN standard gauges to fit into ANSI standard panel cutouts.

U CLAMPS



| Part # | Size | Gauge Series |
|---------|--------|--------------|
| 2440-UC | 2 1/2" | 40 / 41 |
| 2454-UC | 2 1/2" | 54 |
| 4440-UC | 4" | 40 |

No case studs required. Clamp attaches to groove in connection. Rings can be rotated 360°.

CLAMP RINGS



| Part # | Size | Gauge Series |
|------------|--------|--------------|
| 0430/40-CR | 1 1/2" | 30 / 40 / 41 |
| 1430/40-CR | 2" | 30 / 40 / 41 |
| 2440-CR | 2 1/2" | 30 / 40 / 41 |

Totally circular rings with two eccentric screws on each side to fully hold the pressure gauge into a panel. Rings can be rotated 360°.

ADAPTERS



| Part # | Fitting Style | Connection Size |
|------------|---------------|-----------------------|
| AB-1418 | Reducer | 1/4" FNPT x 1/8" MNPT |
| AB-1412-HE | Adapter | 1/4" FNPT x 1/2" MNPT |

THREADED LENSES



| Part # | Size | Gauge Series |
|--------|--------|--------------|
| AF-212 | 2 1/2" | 80 |

Screw-on cover made of polycarbonate.

GAUGE DAMPENER

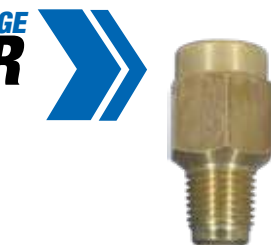

| Part # | Connection Size |
|--------|-----------------------|
| GD-14 | 1/4" FNPT x 1/4" MNPT |

Snubber that protects from pressure surges.

NYLON & POLYPROPYLENE FITTINGS



Our nylon fittings are made from high quality type 6 virgin resin. Nylon fittings are generally acceptable for use at working pressures up to 150 PSI at normal room temperatures. At very low pressures, temperatures can approach 175° F with no degradation.

Our polypropylene fittings are made 10% glass polypropylene resin. Polypropylene fittings are generally acceptable for use at working pressures up to 150 PSI at ambient temperatures. As with all thermoplastics, an increase in working temperature is accompanied by a decrease in operating pressure.



RETAIL READY CLAMSHELL PACKAGING

VALLEY INDUSTRIES offers the option of high quality clamshell retail display packaging on select fittings.

Contact us for minimum quantities and availability!

WHITE NYLON

BLACK POLY

| RECOMMENDED USAGE | NOT RECOMMENDED |
|--------------------------------------|---------------------------------|
| Ammonium Compounds | Acids or Acid Based Fertilizers |
| Detergents | Bromine |
| Diesel, Ethanol or Gasoline | Chlorine |
| Magnesium Sulfate | Fluorine |
| Sodium Compounds | Iodine |
| Trichloroethylene | Xylene Based Chemicals |
| Zinc Sulphate | Extreme UV Exposure |
| High Structural or Physical Strength | |
| Sealant Tape | |
| PHYSICAL PROPERTIES | |
| Specific Gravity | 1.12 |
| Heat Distortion | 375° F |
| Rockwell Hardness (R) | 120 |
| Izod Impact | 1.0 ft. - lbs./in |
| Temp Range | 0° - 200° F |
| Color | White |

| RECOMMENDED USAGE | NOT RECOMMENDED |
|---------------------------------|-----------------------------------|
| Acids or Acid Based Fertilizers | Aromatic Hydrocarbons |
| Ammonium Compounds | Carbon Tetrachloride |
| Calcium Carbonate | Gasoline or Kerosene |
| Ethanol | Nitric Acid |
| Magnesium Sulfate | Sodium Hypochlorate |
| Sodium Compounds | Toluene or Xylene Based Chemicals |
| Extreme UV Exposure | Impact Wrenches or Overtightening |
| | Sealant Tape |
| PHYSICAL PROPERTIES | |
| Specific Gravity | 0.98 |
| Heat Distortion | 285° F |
| Rockwell Hardness (R) | 100 |
| Izod Impact | 0.8 ft. - lbs./in |
| Temp Range | 32° -150° F |
| Color | Black |

ABBREVIATIONS

| | | | |
|-------------------------------|-------------------------------------|---------------------------------------|--|
| MPS Male Pipe Straight | FPS Female Pipe Straight | MNPT Male National Pipe Thread | FNPT Female National Pipe Thread |
| HB Hose Barb | MGHT Male Garden Hose Thread | FGHT Female Garden Hose Thread | FBSP Female British Straight Pipe |

PIPE NYLON &

MNPTxHB HOSE BARBS



| Nylon | Poly | Connection Size |
|---------------------|----------------------|-----------------|
| A18316 [^] | 3A18316 [^] | 1/8" x 3/16" |
| A1814** | 3A1814 | 1/8" x 1/4" |
| A18516 [^] | 3A18516 [^] | 1/8" x 5/16" |
| A1838 | 3A1838 | 1/8" x 3/8" |
| A14316 | 3A14316 [^] | 1/4" x 3/16" |
| A14** | 3A14 | 1/4" x 1/4" |
| A14516 [^] | 3A14516 [^] | 1/4" x 5/16" |
| A1438** | 3A1438 | 1/4" x 3/8" |
| A1412 | 3A1412 | 1/4" x 1/2" |
| A3814 | 3A3814 | 3/8" x 1/4" |
| A38516 | 3A38516 [^] | 3/8" x 5/16" |
| A38** | 3A38 | 3/8" x 3/8" |
| A3812** | 3A3812 | 3/8" x 1/2" |
| A3858** | 3A3858 | 3/8" x 5/8" |
| A1214** | 3A1214 | 1/2" x 1/4" |
| A1238** | 3A1238 | 1/2" x 3/8" |
| A12** | 3A12 | 1/2" x 1/2" |
| A1258** | 3A1258 | 1/2" x 5/8" |
| A1234** | 3A1234 | 1/2" x 3/4" |
| A3414 | 3A3414 [^] | 3/4" x 1/4" |
| A3438 | 3A3438 | 3/4" x 3/8" |
| A3412 | 3A3412 | 3/4" x 1/2" |
| A3458 | 3A3458 | 3/4" x 5/8" |
| A34 | 3A34 | 3/4" x 3/4" |
| A34100** | 3A34100 | 3/4" x 1" |
| A10034** | 3A10034 | 1" x 3/4" |
| A100** | 3A100 | 1" x 1" |
| A100114 | 3A100114 | 1" x 1 1/4" |
| A11434 | 3A11434 | 1 1/4" x 3/4" |
| A114100 | 3A114100 | 1 1/4" x 1" |
| A114 | 3A114 | 1 1/4" x 1 1/4" |
| A114112 | 3A114112 | 1 1/4" x 1 1/2" |
| A112114 | 3A112114 | 1 1/2" x 1 1/4" |
| A112 • | 3A112 | 1 1/2" x 1 1/2" |
| A200 • | 3A200 | 2" x 2" |

MNPTxHB ELBOWS



| Nylon | Poly | Connection Size |
|----------------------|-----------------------|-----------------|
| EL1814 | 3EL1814 | 1/8" x 1/4" |
| EL1838 | 3EL1838 | 1/8" x 3/8" |
| EL14316 | 3EL14316 | 1/4" x 3/16" |
| EL14 | 3EL14 | 1/4" x 1/4" |
| EL14516 [^] | 3EL14516 [^] | 1/4" x 5/16" |
| EL1438 | 3EL1438 | 1/4" x 3/8" |
| EL1412 | 3EL1412 | 1/4" x 1/2" |
| EL3814 [^] | 3EL3814 | 3/8" x 1/4" |
| EL38516 | 3EL38516 [^] | 3/8" x 5/16" |
| EL38** | 3EL38 | 3/8" x 3/8" |
| EL3812** | 3EL3812 | 3/8" x 1/2" |
| EL3858 | 3EL3858 | 3/8" x 5/8" |
| EL1214 | 3EL1214 | 1/2" x 1/4" |
| EL1238** | 3EL1238 | 1/2" x 3/8" |
| EL12** | 3EL12 | 1/2" x 1/2" |
| EL1258** | 3EL1258 | 1/2" x 5/8" |
| EL1234** | 3EL1234 | 1/2" x 3/4" |
| EL3414 | 3EL3414 [^] | 3/4" x 1/4" |
| EL3438** | 3EL3438 | 3/4" x 3/8" |
| EL3412** | 3EL3412 | 3/4" x 1/2" |
| EL3458 | 3EL3458 | 3/4" x 5/8" |
| EL34** | 3EL34 | 3/4" x 3/4" |
| EL34100 • | 3EL34100 | 3/4" x 1" |
| EL100 | 3EL100 | 1" x 1" |
| EL10012 | 3EL10012 | 1" x 1 1/2" |
| EL10034 | 3EL10034 | 1" x 3/4" |
| EL114 | 3EL114 | 1 1/4" x 1 1/4" |
| EL114100 | 3EL114100 | 1 1/4" x 1" |
| EL112 • | 3EL112 | 1 1/2" x 1 1/2" |
| EL200 | 3EL200 | 2" x 2" |

FNPTxHB ELBOWS



| Nylon | Poly | Connection Size |
|-----------------------|------------------------|-----------------|
| EL1814F | 3EL1814F [^] | 1/8" x 1/4" |
| EL1838F [^] | 3EL1838F [^] | 1/8" x 3/8" |
| EL14316F [^] | 3EL14316F [^] | 1/4" x 3/16" |
| EL14F | 3EL14F | 1/4" x 1/4" |
| EL1438F [^] | 3EL1438F [^] | 1/4" x 3/8" |
| EL3814F | 3EL3814F [^] | 3/8" x 1/4" |
| EL38F [^] | 3EL38F | 3/8" x 3/8" |
| EL3812F [^] | 3EL3812F | 3/8" x 1/2" |
| EL12F | 3EL12F | 1/2" x 1/2" |
| EL1258F | 3EL1258F [^] | 1/2" x 5/8" |
| EL1234F [^] | 3EL1234F | 1/2" x 3/4" |
| EL3412F | 3EL3412F | 3/4" x 1/2" |
| EL3458F [^] | 3EL3458F [^] | 3/4" x 5/8" |
| EL34F | 3EL34F | 3/4" x 3/4" |

**Add -CSK suffix for clamshell retail packaging. • Add BC- prefix for barcoded product. [^]Non-stock item, call for availability and pricing.

FITTINGS

POLYPROPYLENE



FNPTxFNPT ELBOWS

| Nylon | Poly | Connection Size |
|-------|--------|-----------------|
| N/A | 3LL12 | 1/2" x 1/2" |
| N/A | 3LL34 | 3/4" x 3/4" |
| LL100 | N/A | 1" x 1" |
| LL114 | 3LL114 | 1 1/4" x 1 1/4" |
| LL112 | N/A | 1 1/2" x 1 1/2" |

FNPTxHB HOSE BARBS

| Nylon | Poly | Connection size |
|---------|----------|-----------------|
| A14F | 3A14F | 1/4" x 1/4" |
| A1438F | 3A1438F | 1/4" x 3/8" |
| A3814F^ | 3A3814F^ | 3/8" x 1/4" |
| A38F | 3A38F | 3/8" x 3/8" |
| A3812F^ | 3A3812F | 3/8" x 1/2" |
| A1214F^ | 3A1214F | 1/2" x 1/4" |
| A1238F | 3A1238F | 1/2" x 3/8" |
| A12F | 3A12F | 1/2" x 1/2" |
| A1258F | 3A1258F^ | 1/2" x 5/8" |
| A1234F^ | 3A1234F | 1/2" x 3/4" |
| A3438F^ | 3A3438F^ | 3/4" x 3/8" |
| A3412F | 3A3412F | 3/4" x 1/2" |
| A3458F^ | 3A3458F^ | 3/4" x 5/8" |
| A34F | 3A34F | 3/4" x 3/4" |

FNPTxMNPT STREET ELBOWS

| Nylon | Poly | Connection Size |
|---------|--------|-----------------|
| SE14 | 3SE14 | 1/4" x 1/4" |
| SE38 | 3SE38 | 3/8" x 3/8" |
| SE12 | 3SE12 | 1/2" x 1/2" |
| SE34 • | 3SE34 | 3/4" x 3/4" |
| SE100 | 3SE100 | 1" x 1" |
| SE112 | 3SE112 | 1 1/2" x 1 1/2" |
| SE200 • | 3SE200 | 2" x 2" |

FNPTxMNPT STREET ELBOWS 45°

| Nylon | Poly | Connection Size |
|--------|---------|-----------------|
| SE3445 | 3SE3445 | 3/4" x 3/4" |

FNPTxFNPT TEES

| Nylon | Poly | Connection Size |
|--------|--------|-----------------|
| TT14 | 3TT14 | 1/4" |
| TT12 | 3TT12 | 1/2" |
| TT34 • | 3TT34 | 3/4" |
| TT100 | 3TT100 | 1" |
| TT114 | 3TT114 | 1 1/4" |
| TT112 | 3TT112 | 1 1/2" |
| TT200 | 3TT200 | 2" |

FNPTxFNPT COUPLINGS

| Nylon | Poly | Connection Size |
|---------|--------|-----------------|
| FC12** | 3FC12 | 1/2" x 1/2" |
| FC34** | 3FC34 | 3/4" x 3/4" |
| FC38 | N/A | 3/8" x 3/8" |
| FC100 | 3FC100 | 1" x 1" |
| FC114 | 3FC114 | 1 1/4" x 1 1/4" |
| FC112 | 3FC112 | 1 1/2" x 1 1/2" |
| FC200 • | 3FC200 | 2" x 2" |

**Add -CSK suffix for clamshell retail packaging. • Add BC- prefix for barcoded product. ^Non-stock item, call for availability and pricing.



PIPE

NYLON &

REDUCING NIPPLES

MNPTxMNPT



| Nylon | Poly | Connection Size |
|---------------------|---------------------|-----------------|
| M1418 [^] | 3M1418 | 1/4" x 1/8" |
| M3818 | 3M3818 [^] | 3/8" x 1/8" |
| M3814 | 3M3814 | 3/8" x 1/4" |
| M1214 | 3M1214 | 1/2" x 1/4" |
| M1238 | 3M1238 | 1/2" x 3/8" |
| M3438 [^] | 3M3438 | 3/4" x 3/8" |
| M3412 ^{**} | 3M3412 | 3/4" x 1/2" |

MNPTxMNPT NIPPLES



| Nylon | Poly | Connection Size |
|-------------------|-------|-----------------|
| M18 [^] | 3M18 | 1/8" x 1/8" |
| M14 | 3M14 | 1/4" x 1/4" |
| M38 | 3M38 | 3/8" x 3/8" |
| M12 | 3M12 | 1/2" x 1/2" |
| M34 ^{**} | 3M34 | 3/4" x 3/4" |
| M100 | 3M100 | 1" x 1" |
| M114 | 3M114 | 1 1/4" x 1 1/4" |
| M112 • | 3M112 | 1 1/2" x 1 1/2" |
| M200 • | 3M200 | 2" x 2" |

REDUCER BUSHINGS

MNPTxFNPT



| Nylon | Poly | Connection Size |
|-----------------------|----------------------|-----------------|
| RB3818 [^] | 3RB3818 | 3/8" x 1/8" |
| RB3814 ^{**} | 3RB3814 | 3/8" x 1/4" |
| RB1218 | 3RB1218 [^] | 1/2" x 1/8" |
| RB1214 ^{**} | 3RB1214 | 1/2" x 1/4" |
| RB1238 ^{**} | 3RB1238 | 1/2" x 3/8" |
| RB3418 [^] | 3RB3418 | 3/4" x 1/8" |
| RB3414 ^{**} | 3RB3414 | 3/4" x 1/4" |
| RB3438 | 3RB3438 | 3/4" x 3/8" |
| RB3412 | 3RB3412 | 3/4" x 1/2" |
| RB10012 ^{**} | 3RB10012 | 1" x 1/2" |
| RB10034 ^{**} | 3RB10034 | 1" x 3/4" |
| RB11434 • | 3RB11434 | 1 1/4" x 3/4" |
| RB114100 • | 3RB114100 | 1 1/4" x 1" |
| RB11234 | N/A | 1 1/2" x 3/4" |
| RB112100 • | 3RB112100 | 1 1/2" x 1" |
| RB112114 • | 3RB112114 | 1 1/2" x 1 1/4" |
| RB20034 | 3RB20034 | 2" x 3/4" |
| RB200100 | 3RB200100 | 2" x 1" |
| RB200114 • | 3RB200114 | 2" x 1 1/4" |
| RB200112 • | 3RB200112 | 2" x 1 1/2" |
| RB300200 | 3RB300200 | 3" x 2" |

FNPTxFNPT TEES

1/4" GAUGE PORT



| Nylon | Poly | Connection Size |
|---------|----------|-----------------|
| GTT1214 | 3GTT1214 | 1/2" |
| GTT3414 | 3GTT3414 | 3/4" |

MNPT HEX PLUGS



| Nylon | Poly | Connection Size |
|-------------------|-------|-----------------|
| F18 | 3F18 | 1/8" |
| F14 ^{**} | 3F14 | 1/4" |
| F38 | 3F38 | 3/8" |
| F12 ^{**} | 3F12 | 1/2" |
| F34 ^{**} | 3F34 | 3/4" |
| F100 | 3F100 | 1" |
| F114 | 3F114 | 1 1/4" |
| F112 | 3F112 | 1 1/2" |
| F200 | 3F200 | 2" |

**Add -CSK suffix for clamshell retail packaging. • Add BC- prefix for barcoded product. [^]Non-stock item, call for availability and pricing.

FITTINGS

POLYPROPYLENE



HEX HOSE MENDERS HBxHB

| Nylon | Poly | Connection Size |
|-----------|----------|-----------------|
| SHM14** | 3SHM14 | 1/4" x 1/4" |
| SHM38** | 3SHM38 | 3/8" x 3/8" |
| SHM1238** | 3SHM1238 | 1/2" x 3/8" |
| SHM12** | 3SHM12 | 1/2" x 1/2" |
| SHM1258 | 3SHM1258 | 1/2" x 5/8" |
| SHM58 | 3SHM58 | 5/8" x 5/8" |
| SHM34 | 3SHM34 | 3/4" x 3/4" |
| SHM100 | 3SHM100 | 1" x 1" |
| SHM114 | 3SHM114 | 1 1/4" x 1 1/4" |
| SHM112 | 3SHM112 | 1 1/2" x 1 1/2" |
| SHM200 | 3SHM200 | 2" x 2" |

With Center Stop.



HOSE MENDERS HBxHB

| Nylon | Poly | Connection Size |
|---------|-----------|-----------------|
| HM14316 | 3HM14316^ | 1/4" x 3/16" |
| HM14 | 3HM14^ | 1/4" x 1/4" |
| HM516^ | 3HM516^ | 5/16" x 5/16" |
| HM3814^ | 3HM3814 | 3/8" x 1/4" |
| HM1214 | 3HM1214^ | 1/2" x 1/4" |
| HM1238^ | 3HM1238^ | 1/2" x 3/8" |
| HM5838 | 3HM5838^ | 5/8" x 3/8" |
| HM58 | 3HM58^ | 5/8" x 5/8" |

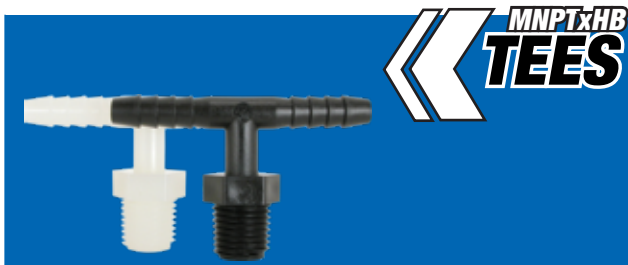

MNPTxHB TEES

| Nylon | Poly | Connection Size |
|---------|----------|-----------------|
| T1814T | 3T1814T^ | 1/8" x 1/4" |
| T14T | 3T14T | 1/4" x 1/4" |
| T1438T | 3T1438T | 1/4" x 3/8" |
| T1412T | 3T1412T | 1/4" x 1/2" |
| T3814T^ | 3T3814T^ | 3/8" x 1/4" |
| T38T^ | 3T38T | 3/8" x 3/8" |
| T3812T^ | 3T3812T^ | 3/8" x 1/2" |
| T1238T | 3T1238T | 1/2" x 3/8" |
| T12T | 3T12T | 1/2" x 1/2" |
| T1258T^ | 3T1258T^ | 1/2" x 5/8" |
| T1234T^ | 3T1234T^ | 1/2" x 3/4" |
| T3438T^ | 3T3438T | 3/4" x 3/8" |
| T3412T^ | 3T3412T^ | 3/4" x 1/2" |
| T3458T^ | 3T3458T^ | 3/4" x 5/8" |
| T34T | 3T34T | 3/4" x 3/4" |



HBxHB TEES

| Nylon | Poly | Connection Size |
|--------|---------|-----------------|
| T14 | 3T14 | 1/4" x 1/4" |
| T1438 | 3T1438 | 1/4" x 3/8" |
| T38** | 3T38 | 3/8" x 3/8" |
| T3812 | 3T3812 | 3/8" x 1/2" |
| T3858^ | 3T3858^ | 3/8" x 5/8" |
| T1238 | 3T1238 | 1/2" x 3/8" |
| T12** | 3T12 | 1/2" x 1/2" |
| T58 | 3T58 | 5/8" x 5/8" |
| T3412 | 3T3412 | 3/4" x 1/2" |
| T34 | 3T34 | 3/4" x 3/4" |
| T100 | 3T100 | 1" x 1" |
| T114 | 3T114 | 1 1/4" x 1 1/4" |
| T112 | 3T112 | 1 1/2" x 1 1/2" |
| T200^ | 3T200 | 2" x 2" |

**Add -CSK suffix for clamshell retail packaging. • Add BC- prefix for barcoded product. ^Non-stock item, call for availability and pricing.



PIPE NYLON &

MGHTxHB ADAPTERS



| Nylon | Poly | Connection Size |
|---------|---------------------|-----------------|
| D3414 | 3D3414 [^] | 3/4" x 1/4" |
| D3438** | 3D3438 | 3/4" x 3/8" |
| D3412** | 3D3412 | 3/4" x 1/2" |
| D3458 | 3D3458 | 3/4" x 5/8" |
| D34** | 3D34 | 3/4" x 3/4" |

MGHTxHB ELBOWS



| Nylon | Poly | Connection Size |
|----------------------|-----------------------|-----------------|
| ELD3414 [^] | 3ELD3414 [^] | 3/4" x 1/4" |
| ELD3438 [^] | 3ELD3438 [^] | 3/4" x 3/8" |
| ELD3412 [^] | 3ELD3412 [^] | 3/4" x 1/2" |
| ELD3458 [^] | 3ELD3458 | 3/4" x 5/8" |
| ELD34 | 3ELD34 | 3/4" x 3/4" |

FNPTxHB ADAPTERS



| Nylon | Poly | Connection Size |
|------------------|------|-----------------|
| Q14 [^] | 3Q14 | 1/4" x 1/4" |
| Q12 | 3Q12 | 1/2" x 1/2" |

HBxHB ELBOWS



| Nylon | Poly | Connection Size |
|-----------------------|------------------------|-----------------|
| EL14HB | 3EL14HB | 1/4" x 1/4" |
| EL3814HB | 3EL3814HB | 3/8" x 1/4" |
| EL38HB | 3EL38HB | 3/8" x 3/8" |
| EL1214HB [^] | 3EL1214HB [^] | 1/2" x 1/4" |
| EL1238HB | 3EL1238HB | 1/2" x 3/8" |
| EL12HB** | 3EL12HB | 1/2" x 1/2" |
| EL58HB | 3EL58HB | 5/8" x 5/8" |
| EL3458HB [^] | 3EL3458HB [^] | 3/4" x 5/8" |
| EL34HB | 3EL34HB | 3/4" x 3/4" |
| EL100HB | 3EL100HB | 1" x 1" |

FLAT SEAT HOSE BARBS



| Nylon | Poly | Connection Size |
|-------------------|--------------------|-----------------|
| C14 | 3C14 | 1/4" |
| C38** | 3C38 | 3/8" |
| C12 | 3C12 | 1/2" |
| C58 | 3C58 | 5/8" |
| C34 | 3C34 | 3/4" |
| C100 [^] | 3C100 [^] | 1" |

FNPTxHB TEES



| Nylon | Poly | Connection Size |
|-------|-------|-----------------|
| T34F | 3T34F | 3/4" x 3/4" |

**Add -CSK suffix for clamshell retail packaging. • Add BC- prefix for barcoded product. [^]Non-stock item, call for availability and pricing.

FITTINGS

POLYPROPYLENE



MGHTxMNPT ADAPTERS

| Nylon | Poly | Connection Size |
|---------|--------|-----------------|
| E3438 | 3E3438 | 3/4" x 3/8" |
| E3412** | 3E3412 | 3/4" x 1/2" |
| E34** | 3E34 | 3/4" x 3/4" |

FGHTxFNPT ADAPTER COUPLINGS

| Nylon | Poly | Connection Size |
|---------|--------|-----------------|
| J3412** | 3J3412 | 3/4" x 1/2" |

MGHTxFGHT ADAPTERS

| Nylon | Poly | Connection Size |
|-------|------|-----------------|
| I34 | 3I34 | 3/4" x 3/4" |

FGHTxMNPT ADAPTERS

| Nylon | Poly | Connection Size |
|-------|------|-----------------|
| H34 | 3H34 | 3/4" x 3/4" |

MGHTxFNPT ADAPTERS

| Nylon | Poly | Connection Size |
|--------|---------|-----------------|
| G3414^ | 3G3414^ | 3/4" x 1/4" |
| G3412 | 3G3412 | 3/4" x 1/2" |
| G34 | 3G34 | 3/4" x 3/4" |

MPSxMNPT NIPPLES

| Nylon | Poly | Connection Size |
|--------|-----------|-----------------|
| NB1614 | 3NB1614** | 1/4" x 1/4" |
| NB1612 | 3NB1612 | 1/4" x 1/2" |

**Add -CSK suffix for clamshell retail packaging. • Add BC- prefix for barcoded product. ^Non-stock item, call for availability and pricing.



PIPE NYLON &

STRAIGHT
SWIVEL NUTS
FGHT



| Nylon | Poly | Connection Size |
|-------|------|-----------------|
| B34** | 3B34 | 3/4" |

FPS NOZZLE
RETAINING
NUTS



| Nylon | Poly | Connection Size |
|-------|------|-----------------|
| B12 | 3B12 | 1/16" |

MPSxHB
ELBOWS



| Nylon | Poly | Connection Size |
|---------|----------|-----------------|
| NTL14 | 3NTL14 | 1/16" x 1/4" |
| NTL38 | 3NTL38 | 1/16" x 3/8" |
| NTL38-C | 3NTL38-C | 1/16" x 3/8" |
| NTL12 | 3NTL12 | 1/16" x 1/2" |
| NTL12-C | 3NTL12-C | 1/16" x 1/2" |
| NTL58 | 3NTL58 | 1/16" x 5/8" |
| NTL34 | 3NTL34 | 1/16" x 3/4" |

Hose barb with nozzle thread "L" standard nozzle body.
Includes B12 Nut (Except -C Models).

MPSxHB
TEES



| Nylon | Poly | Connection Size |
|---------|----------|-----------------|
| NTT38 | 3NTT38 | 1/16" x 3/8" |
| NTT38-C | 3NTT38-C | 1/16" x 3/8" |
| NTT12 | 3NTT12 | 1/16" x 1/2" |
| NTT12-C | 3NTT12-C | 1/16" x 1/2" |
| NTT58 | 3NTT58 | 1/16" x 5/8" |
| NTT34 | 3NTT34 | 1/16" x 3/4" |
| NTT34-C | 3NTT34-C | 1/16" x 3/4" |

Hose barb with nozzle thread "T" standard nozzle body.
Includes B12 Nut (Except -C Models).

FOR 8027 NUT
HOSE BARBS



| Nylon | Poly | Connection Size |
|--------|--------|-----------------|
| K8414 | 3K8414 | 1/4" |
| K8438^ | 3K8438 | 3/8" |
| K8412 | 3K8412 | 1/2" |

MPSxHB STRAIGHT
HOSE BARBS
WITH NOZZLE THREAD



| Nylon | Poly | Connection Size |
|---------|----------|-----------------|
| 38D | 338D | 1/16" x 3/8" |
| 38D-C | 338D-C | 1/16" x 3/8" |
| 3812D | 33812D | 1/16" x 1/2" |
| 3812D-C | 33812D-C | 1/16" x 1/2" |

Includes B12 Nut (Except -C Models).

**Add -CSK suffix for clamshell retail packaging. • Add BC- prefix for barcoded product. ^Non-stock item, call for availability and pricing.

FITTINGS

POLYPROPYLENE



NOZZLE NUTS FPS



| Nylon | Poly | Connection Size |
|--------|-------|-----------------|
| 8027** | 38027 | 1/16" |

NOZZLE CAPS



| Nylon | Poly | Connection Size |
|-------|-------|-----------------|
| 3942 | 33942 | 1/16" |

MPSxHB CROSSES



| Nylon | Poly | Connection Size |
|-------|-------|-----------------|
| T38C | 3T38C | 1/16" x 3/8" |
| T12C^ | 3T12C | 1/16" x 1/2" |
| T34C | 3T34C | 1/16" x 3/4" |

Includes B12 Nut

FGHT CAPS



| Nylon | Poly | Connection Size |
|-------|------|-----------------|
| N34 | 3N34 | 3/4" |

CROSS 1/4" GAUGE PORT



| Black Nylon | Connection Size |
|-------------|-----------------|
| GCR1214-BN | 1/2" x 1/4" |

SPRAY TIP ADAPTERS

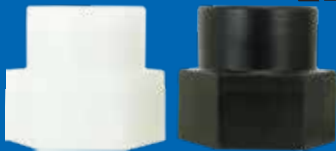

| Nylon | Poly | Connection Size |
|--------|-----------|-----------------|
| NF1614 | 3NF1614** | 1/16" x 1/4" |

Female spray tip adaptor.

**Add -CSK suffix for clamshell retail packaging. • Add BC- prefix for barcoded product. ^Non-stock item, call for availability and pricing.



CAMLOCK

VALLEY INDUSTRIES polypropylene Camlocks allow you to quickly connect and disconnect fittings on pipes or hoses and are available in a wide variety of sizes and styles. Each camlock listed below is barcoded for retail sale.

TYPE-A



| Part # | Size |
|--------------|------|
| CL-A-100P-BC | 1" |
| CL-A-150P-BC | 1½" |
| CL-A-200P-BC | 2" |
| CL-A-300P-BC | 3" |

Includes a male grooved adapter and a female pipe thread.

TYPE-B



| Part # | Size |
|--------------|------|
| CL-B-075P-BC | ¾" |
| CL-B-150P-BC | 1½" |
| CL-B-200P-BC | 2" |
| CL-B-300P-BC | 3" |

Includes a female camlock and a male pipe thread.

TYPE-C



| Part # | Size |
|--------------|------|
| CL-C-100P-BC | 1" |
| CL-C-150P-BC | 1½" |
| CL-C-200P-BC | 2" |
| CL-C-300P-BC | 3" |

Includes a female camlock and a male hose barb.

TYPE-D



| Part # | Size |
|--------------|------|
| CL-D-100P-BC | 1" |
| CL-D-150P-BC | 1½" |
| CL-D-200P-BC | 2" |

Includes a female camlock and a female pipe thread.

FITTINGS



TYPE-E



| Part # | Size |
|--------------|--------|
| CL-E-075P-BC | 3/4" |
| CL-E-100P-BC | 1" |
| CL-E-150P-BC | 1 1/2" |
| CL-E-200P-BC | 2" |

Includes a male grooved adaptor and a male hose barb.

TYPE-F



| Part # | Size |
|--------------|--------|
| CL-F-100P-BC | 1" |
| CL-F-150P-BC | 1 1/2" |
| CL-F-200P-BC | 2" |
| CL-F-300P-BC | 3" |

Includes a male grooved adaptor and a male pipe thread.

CAMLOCK CAP



| Part # | Size |
|---------------|------|
| CL-CP-200P-BC | 2" |

CAMLOCK PLUG



| Part # | Size |
|---------------|--------|
| CL-PL-150P-BC | 1 1/2" |
| CL-PL-200P-BC | 2" |





APPLICATIONS & NUMBERING

Our stainless steel fittings and pipe nipples are made from 304 or 316 stainless steel. They are for use with air, water, oil, natural gas, and steam under a maximum pressure 150 PSI at 72°F.

*304 prefix designates 304 stainless steel.
316 prefix designates 316 stainless steel.*

PIPE FITTINGS STAINLESS STEEL

ABBREVIATIONS

MPS Male Pipe Straight **FPS** Female Pipe Straight **MNPT** Male National Pipe Thread **FNPT** Female National Pipe Thread
HB Hose Barb **MGHT** Male Garden Hose Thread **FGHT** Female Garden Hose Thread **FBSP** Female British Straight Pipe

^{FNPT} CAPS



| Part# | Connection Size |
|-----------|-----------------|
| 304-CP18 | 1/8" |
| 304-CP14 | 1/4" |
| 304-CP38 | 3/8" |
| 304-CP12 | 1/2" |
| 304-CP34 | 3/4" |
| 304-CP100 | 1" |
| 304-CP114 | 1 1/4" |
| 304-CP112 | 1 1/2" |
| 304-CP200 | 2" |
| 304-CP300 | 3" |
| 304-CP400 | 4" |

^{FNPT} CROSSES



| Part# | Connection Size |
|-----------|-----------------|
| 304-CR18 | 1/8" |
| 304-CR14 | 1/4" |
| 304-CR38 | 3/8" |
| 304-CR12 | 1/2" |
| 304-CR34 | 3/4" |
| 304-CR100 | 1" |
| 304-CR114 | 1 1/4" |
| 304-CR112 | 1 1/2" |
| 304-CR200 | 2" |
| 304-CR300 | 3" |
| 304-CR400 | 4" |

^{MNPTxHB} FITTINGS



| Part# | Connection Size |
|------------|-----------------|
| 316-A14 | 1/4" x 1/4" |
| 316-A1438 | 1/4" x 3/8" |
| 316-A1412 | 1/4" x 1/2" |
| 316-A38 | 3/8" x 3/8" |
| 316-A3812 | 3/8" x 1/2" |
| 316-A12 | 1/2" x 1/2" |
| 316-A1238 | 1/2" x 3/8" |
| 316-A1258 | 1/2" x 5/8" |
| 316-A1234 | 1/2" x 3/4" |
| 316-A3412 | 3/4" x 1/2" |
| 316-A34 | 3/4" x 3/4" |
| 316-A34100 | 3/4" x 1" |
| 316-A10034 | 1" x 3/4" |
| 316-A100 | 1" x 1" |
| 316-A114 | 1 1/4" x 1 1/4" |
| 316-A112 | 1 1/2" x 1 1/2" |
| 316-A200 | 2" x 2" |
| 316-A300 | 3" x 3" |
| 316-A400 | 4" x 4" |

PIPE FITTINGS

STAINLESS STEEL

FNPTxFNPT COUPLINGS



| Part# | Connection Size |
|------------|---------------------------|
| 304-FC18 | 1/8" x 1/8" |
| 304-FC14 | 1/4" x 1/4" |
| 304-FC38 | 3/8" x 3/8" |
| 304-FC12 | 1/2" x 1/2" |
| 304-FC34 | 3/4" x 3/4" |
| 304-FC100 | 1" x 1" |
| 304-FC114 | 1 1/4" x 1 1/4" |
| 304-FC112 | 1 1/2" x 1 1/2" |
| 304-FC200 | 2" x 2" |
| 304-FC300 | 3" x 3" |
| 304-FC400 | 4" x 4" |
| 304-FHC14 | 1/4" x 1/4" Half Coupling |
| 304-FHC38 | 3/8" x 3/8" Half Coupling |
| 304-FHC12 | 1/2" x 1/2" Half Coupling |
| 304-FHC100 | 1" x 1" Half Coupling |

MNPTxFNPT BUSHINGS



| Part# | Connection Size |
|--------------|-----------------|
| 304-RB1418 | 1/4" x 1/8" |
| 304-RB3814 | 3/8" x 1/4" |
| 304-RB1218 | 1/2" x 1/8" |
| 304-RB1214 | 1/2" x 1/4" |
| 304-RB1238 | 1/2" x 3/8" |
| 304-RB3414 | 3/4" x 1/4" |
| 304-RB3438 | 3/4" x 3/8" |
| 304-RB3412 | 3/4" x 1/2" |
| 304-RB10012 | 1" x 1/2" |
| 304-RB10034 | 1" x 3/4" |
| 304-RB11434 | 1 1/4" x 3/4" |
| 304-RB114100 | 1 1/4" x 1" |
| 304-RB11234 | 1 1/2" x 3/4" |
| 304-RB112100 | 1 1/2" x 1" |
| 304-RB112114 | 1 1/2" x 1 1/4" |
| 304-RB200100 | 2" x 1" |
| 304-RB200114 | 2" x 1 1/4" |
| 304-RB200112 | 2" x 1 1/2" |
| 304-RB300200 | 3" x 2" |
| 304-RB400300 | 4" x 3" |

MNPT HEX PLUGS



| Part# | Connection Size |
|----------|-----------------|
| 304-F18 | 1/8" |
| 304-F14 | 1/4" |
| 304-F38 | 3/8" |
| 304-F12 | 1/2" |
| 304-F34 | 3/4" |
| 304-F100 | 1" |
| 304-F114 | 1 1/4" |
| 304-F112 | 1 1/2" |
| 304-F200 | 2" |
| 304-F300 | 3" |
| 304-F400 | 4" |

FNPTxFNPT ELBOWS 45°



| Part# | Connection Size |
|------------|-----------------|
| 304-LL185 | 1/8" x 1/8" |
| 304-LL145 | 1/4" x 1/4" |
| 304-LL385 | 3/8" x 3/8" |
| 304-LL125 | 1/2" x 1/2" |
| 304-LL345 | 3/4" x 3/4" |
| 304-LL1005 | 1" x 1" |
| 304-LL1145 | 1 1/4" x 1 1/4" |
| 304-LL1125 | 1 1/2" x 1 1/2" |
| 304-LL2005 | 2" x 2" |
| 304-LL3005 | 3" x 3" |
| 304-LL4005 | 4" x 4" |

FNPTxFNPT ELBOWS



| Part# | Connection Size |
|-----------|-----------------|
| 304-LL18 | 1/8" x 1/8" |
| 304-LL14 | 1/4" x 1/4" |
| 304-LL38 | 3/8" x 3/8" |
| 304-LL12 | 1/2" x 1/2" |
| 304-LL34 | 3/4" x 3/4" |
| 304-LL100 | 1" x 1" |
| 304-LL114 | 1 1/4" x 1 1/4" |
| 304-LL112 | 1 1/2" x 1 1/2" |
| 304-LL200 | 2" x 2" |
| 304-LL300 | 3" x 3" |
| 304-LL400 | 4" x 4" |

FNPTxMNPT STREET ELBOWS



| Part# | Connection Size |
|-----------|-----------------|
| 304-SE18 | 1/8" x 1/8" |
| 304-SE14 | 1/4" x 1/4" |
| 304-SE38 | 3/8" x 3/8" |
| 304-SE12 | 1/2" x 1/2" |
| 304-SE34 | 3/4" x 3/4" |
| 304-SE100 | 1" x 1" |
| 304-SE114 | 1 1/4" x 1 1/4" |
| 304-SE112 | 1 1/2" x 1 1/2" |
| 304-SE200 | 2" x 2" |
| 304-SE300 | 3" x 3" |
| 304-SE400 | 4" x 4" |

PIPE FITTINGS

STAINLESS STEEL

SQUARE HEAD PLUGS MNPT



| Part# | Connection Size |
|-----------|-----------------|
| 304-SP18 | 1/8" |
| 304-SP14 | 1/4" |
| 304-SP38 | 3/8" |
| 304-SP12 | 1/2" |
| 304-SP34 | 3/4" |
| 304-SP100 | 1" |
| 304-SP114 | 1 1/4" |
| 304-SP112 | 1 1/2" |
| 304-SP200 | 2" |
| 304-SP300 | 3" |
| 304-SP400 | 4" |

FNPTxFNPT TEES



| Part# | Connection Size |
|-----------|-----------------|
| 304-TT18 | 1/8" |
| 304-TT14 | 1/4" |
| 304-TT38 | 3/8" |
| 304-TT12 | 1/2" |
| 304-TT34 | 3/4" |
| 304-TT100 | 1" |
| 304-TT114 | 1 1/4" |
| 304-TT112 | 1 1/2" |
| 304-TT200 | 2" |
| 304-TT300 | 3" |
| 304-TT400 | 4" |

FNPTxFNPT UNIONS



| Part# | Connection Size |
|-----------|-----------------|
| 304-UN18 | 1/8" |
| 304-UN14 | 1/4" |
| 304-UN38 | 3/8" |
| 304-UN12 | 1/2" |
| 304-UN34 | 3/4" |
| 304-UN100 | 1" |
| 304-UN114 | 1 1/4" |
| 304-UN112 | 1 1/2" |
| 304-UN200 | 2" |
| 304-UN300 | 3" |
| 304-UN400 | 4" |

MNPTxMNPT NIPPLES



| Part# | Size x Length | Part# | Size x Length | Part# | Size x Length |
|------------|---------------|------------|-----------------|------------|-----------------|
| 304-1834 | 1/8" x 3/4" | 304-12118 | 1/2" x 1 1/8" | 304-114312 | 1 1/4" x 3 1/2" |
| 304-18112 | 1/8" x 1 1/2" | 304-12112 | 1/2" x 1 1/2" | 304-114400 | 1 1/4" x 4" |
| 304-18200 | 1/8" x 2" | 304-12200 | 1/2" x 2" | 304-114500 | 1 1/4" x 5" |
| 304-18212 | 1/8" x 2 1/2" | 304-12212 | 1/2" x 2 1/2" | 304-114600 | 1 1/4" x 6" |
| 304-18300 | 1/8" x 3" | 304-12300 | 1/2" x 3" | 304-112134 | 1 1/2" x 1 3/4" |
| 304-18312 | 1/8" x 3 1/2" | 304-12312 | 1/2" x 3 1/2" | 304-112200 | 1 1/2" x 2" |
| 304-18400 | 1/8" x 4" | 304-12400 | 1/2" x 4" | 304-112212 | 1 1/2" x 2 1/2" |
| 304-18500 | 1/8" x 5" | 304-12500 | 1/2" x 5" | 304-112300 | 1 1/2" x 3" |
| 304-18600 | 1/8" x 6" | 304-12600 | 1/2" x 6" | 304-112312 | 1 1/2" x 3 1/2" |
| 304-1478 | 1/4" x 7/8" | 304-34138 | 3/4" x 1 3/8" | 304-112400 | 1 1/2" x 4" |
| 304-14112 | 1/4" x 1 1/2" | 304-34112 | 3/4" x 1 1/2" | 304-112500 | 1 1/2" x 5" |
| 304-14200 | 1/4" x 2" | 304-34200 | 3/4" x 2" | 304-112600 | 1 1/2" x 6" |
| 304-14212 | 1/4" x 2 1/2" | 304-34212 | 3/4" x 2 1/2" | 304-200200 | 2" x 2" |
| 304-14300 | 1/4" x 3" | 304-34300 | 3/4" x 3" | 304-200212 | 2" x 2 1/2" |
| 304-14312 | 1/4" x 3 1/2" | 304-34312 | 3/4" x 3 1/2" | 304-200300 | 2" x 3" |
| 304-14400 | 1/4" x 4" | 304-34400 | 3/4" x 4" | 304-200312 | 2" x 3 1/2" |
| 304-14500 | 1/4" x 5" | 304-34500 | 3/4" x 5" | 304-200400 | 2" x 4" |
| 304-14600 | 1/4" x 6" | 304-34600 | 3/4" x 6" | 304-200500 | 2" x 5" |
| 304-14800 | 1/4" x 8" | 304-100112 | 1" x 1 1/2" | 304-200600 | 2" x 6" |
| 304-141200 | 1/4" x 12" | 304-100200 | 1" x 2" | 304-300258 | 3" x 2 5/8" |
| 304-38100 | 3/8" x 1" | 304-100212 | 1" x 2 1/2" | 304-300300 | 3" x 3" |
| 304-38112 | 3/8" x 1 1/2" | 304-100300 | 1" x 3" | 304-300312 | 3" x 3 1/2" |
| 304-38200 | 3/8" x 2" | 304-100312 | 1" x 3 1/2" | 304-300400 | 3" x 4" |
| 304-38212 | 3/8" x 2 1/2" | 304-100400 | 1" x 4" | 304-300500 | 3" x 5" |
| 304-38300 | 3/8" x 3" | 304-100500 | 1" x 5" | 304-300600 | 3" x 6" |
| 304-38312 | 3/8" x 3 1/2" | 304-100600 | 1" x 6" | 304-400278 | 4" x 2 7/8" |
| 304-38400 | 3/8" x 4" | 304-114158 | 1 1/4" x 1 5/8" | 304-400400 | 4" x 4" |
| 304-38500 | 3/8" x 5" | 304-114200 | 1 1/4" x 2" | 304-400500 | 4" x 5" |
| 304-38600 | 3/8" x 6" | 304-114212 | 1 1/4" x 2 1/2" | 304-400600 | 4" x 6" |
| 304-38700 | 3/8" x 7" | 304-114300 | 1 1/4" x 3" | | |

Other nipple lengths available. Call for details.

PIPE FITTINGS

BRASS

APPLICATIONS

Our brass fittings are acceptable for most water uses and petroleum applications such as gasoline and diesel fuel. Depending on the design, brass fittings are usually acceptable for use at relatively high pressure (500 PSI) and at temperatures up to 800° F.

Brass fittings are not acceptable for use with nitrogen compounds.

ABBREVIATIONS

MPS Male Pipe Straight FPS Female Pipe Straight MNPT Male National Pipe Thread FNPT Female National Pipe Thread
 HB Hose Barb MGHT Male Garden Hose Thread FGHT Female Garden Hose Thread FBSP Female British Straight Pipe

SWIVELS HOSE BARB



| Part# | Connection Size |
|--------|---------------------|
| 604.2A | 1/2" FBSP x 3/8" HB |
| 604.3A | 1/2" FBSP x 1/2" HB |

HOSE BARBS



| Part# | Connection Size |
|---------|--------------------------|
| 900.046 | 3/4" MGHT x 3/8" HB x 2" |
| 900.047 | 3/4" MGHT x 1/2" HB x 2" |

NOZZLES



| Part# | Connection Size | Orifice |
|-------------|-----------------|---------|
| 900.040-8 | 1/16" FPS | #8 |
| 900.040-18 | 1/16" FPS | #18 |
| 900.054-8 | 1/4" FNPT | #8 |
| 900.054-18 | 1/4" FNPT | #18 |
| 900.054-24M | 1/4" FNPT | #24 |

NIPPLES HEX



| Part# | Connection Size |
|---------|-----------------------|
| 900.023 | 3/4" MGHT x 3/4" MGHT |

NIPPLES HEX



| Part# | Connection Size |
|---------|-----------------------|
| 900.018 | 3/4" MNPT x 3/4" MGHT |

SWIVELS HOSE BARB



| Part# | Connection Size |
|---------|--------------------------|
| 900.021 | 3/4" FGHT x 1/2" HB x 2" |
| 900.034 | 3/4" FGHT x 3/4" HB x 2" |
| 900.046 | 3/4" FGHT x 3/8" HB x 2" |

ADAPTERS GARDEN HOSE



| Part# | Connection Size |
|--------------|-----------------------|
| 8105.0600.00 | 3/4" FGHT x 3/8" MNPT |
| 8105.0601.00 | 3/4" FGHT x 1/2" MNPT |
| 8105.0502.00 | 3/4" FGHT x 1/2" FNPT |

ELBOWS 90° NOZZLE BODY



| Part# | Connection Size |
|---------|---------------------|
| 901.038 | 3/8" HB x 1/16" MPS |
| 900.052 | 1/2" HB x 1/16" MPS |

PIPE FITTINGS

BRASS

NOZZLE BODIES

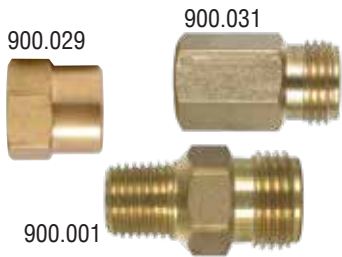

| Part# | Connection Size |
|----------|-----------------------|
| 900.029 | 1/4" FNPT x 1/16" FPS |
| 900.031 | 1/4" FNPT x 1/16" MPS |
| 900.001* | 1/4" MNPT x 1/16" MPS |

*Also Available in Stainless Steel

NOZZLE BODY CAPS FPS



| Part# | Connection Size |
|-------------|------------------------|
| 900.002 | 1/16" FPS (short) |
| 900.002-CSK | 1/16" FPS (short) 4-Pk |
| 900.006 | 1/16" FPS (deep) |

NOZZLE BODY TEES HBxMPS



| Part# | Connection Size |
|---------|---------------------|
| 902.038 | 3/8" HB x 1/16" MPS |
| 900.053 | 1/2" HB x 1/16" MPS |

NOZZLE BLANKS



| Part# | Connection Size |
|-------------|-----------------------------|
| 900.016 | Nozzle Body Block-Off Plate |
| 900.016-CSK | As Above, Clamshelled |

FILTER SCREEN



| Part# | Connection Size |
|---------|---------------------|
| 900.009 | Brass Filter Screen |

NOZZLE BALL VALVE



| Part# | Connection Size |
|------------|-----------------------|
| BBVL-23220 | 1/4" FNPT x 1/16" MPS |
| 91.900.156 | 1/4" MNPT x 1/16" MPS |

NOZZLE BODY SWIVELS SINGLE

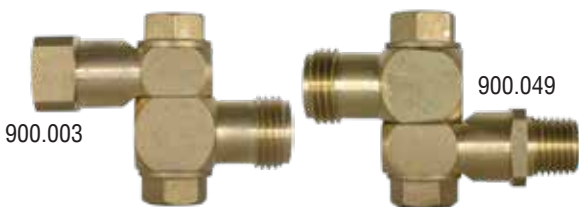

| Part# | Connection Size |
|---------|-----------------------|
| 900.003 | 1/4" FNPT x 1/16" MPS |
| 900.049 | 1/4" MNPT x 1/16" MPS |

NOZZLE BODY SWIVELS DOUBLE



| Part# | Connection Size |
|---------|-----------------------|
| 900.050 | 1/4" MNPT x 1/16" MPS |
| 900.004 | 1/4" FNPT x 1/16" MPS |

BALL VALVES

316 STAINLESS SERIES 86 STANDARD PORT

2 Piece, 2000 PSI Ball Valve
Standard Port 316 Stainless Steel Heavy Wall

| Part# | FNPT | D | L | S | H |
|--------|------|-------|-------|-------|-------|
| 86-14 | ¼" | 0.374 | 2.047 | 4.114 | 2.028 |
| 86-38 | ⅜" | 0.374 | 2.047 | 4.114 | 2.028 |
| 86-12 | ½" | 0.500 | 2.539 | 4.114 | 2.008 |
| 86-34 | ¾" | 0.590 | 2.697 | 5.020 | 2.106 |
| 86-100 | 1" | 0.787 | 3.248 | 5.020 | 2.283 |
| 86-114 | 1¼" | 0.984 | 3.681 | 6.575 | 2.874 |
| 86-112 | 1½" | 1.260 | 4.350 | 6.575 | 3.150 |
| 86-200 | 2" | 1.500 | 4.622 | 7.600 | 3.327 |

FEATURES

Investment cast body and cap.
Teflon® seals and seats for smooth operation and proper seating characteristics.
2000 PSI Rating (Water/Oil/Gas).
-60° to 450° F operating temperature.
Adjustable stem packing.
Blow-out proof stem and ball are made of 316 stainless steel.
Locking device on handle.

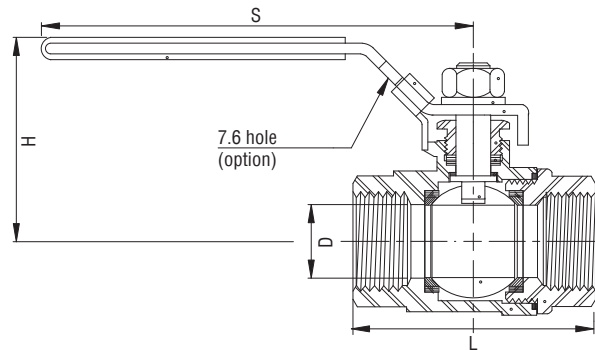

316 STAINLESS SERIES 88 FULL PORT

2 Piece, 1000 PSI Ball Valve
Full Port 316 Stainless Steel

| Part# | FNPT | D | L | S | H |
|--------|------|-------|-------|-------|-------|
| 88-14 | ¼" | 0.456 | 1.831 | 4.094 | 1.890 |
| 88-38 | ⅜" | 0.456 | 1.890 | 4.094 | 1.890 |
| 88-12 | ½" | 0.562 | 2.520 | 4.094 | 2.047 |
| 88-34 | ¾" | 0.787 | 2.913 | 4.843 | 2.402 |
| 88-100 | 1" | 0.984 | 3.425 | 4.843 | 2.559 |
| 88-114 | 1¼" | 1.260 | 3.976 | 6.063 | 3.150 |
| 88-112 | 1½" | 1.496 | 4.331 | 6.063 | 3.307 |
| 88-200 | 2" | 1.969 | 5.197 | 7.441 | 3.819 |
| 88-212 | 2½" | 2.520 | 5.710 | 9.606 | 5.354 |
| 88-300 | 3" | 2.992 | 7.362 | 9.606 | 5.709 |

FEATURES

Investment cast body and cap.
Teflon® seals and seats for smooth operation and proper seating characteristics.
1000 PSI Rating (Water/Oil/Gas).
-60° to 450° F operating temperature.
Adjustable stem packing.
Blow-out proof stem and ball are made of 316 stainless steel.
Locking device on handle.

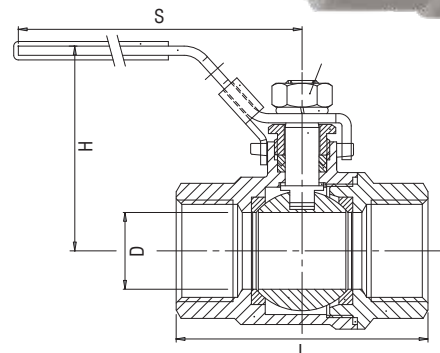

BALL

BRASS BBV SERIES FULL PORT

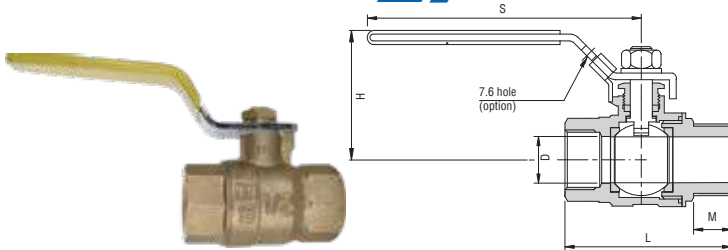

| Part# | FNPT | D | L | S | H |
|---------|--------|------|------|------|------|
| BBV-14 | 1/4" | 0.39 | 2.02 | 3.85 | 1.75 |
| BBV-38 | 3/8" | 0.39 | 2.02 | 3.85 | 1.75 |
| BBV-12 | 1/2" | 0.59 | 2.44 | 3.85 | 1.88 |
| BBV-34 | 3/4" | 0.78 | 2.71 | 4.80 | 2.28 |
| BBV-100 | 1" | 0.98 | 3.07 | 4.80 | 2.44 |
| BBV-114 | 1 1/4" | 1.25 | 3.42 | 6.02 | 3.07 |
| BBV-112 | 1 1/2" | 1.57 | 3.89 | 6.02 | 3.34 |
| BBV-200 | 2" | 1.96 | 4.43 | 6.37 | 3.79 |
| BBV-300 | 3" | 3.00 | 6.06 | 7.75 | 4.50 |

FEATURES

Investment cast body and cap.
Teflon® seals & seats smooth operation & proper seating.
600 PSI rating (W.O.G.) 100 PSI steam.
-40° to 366° F operating temperature.
Adjustable stem packing.
Blow-out proof stem.
Chrome plated brass ball.

BUTTERFLY HANDLE 85 SERIES STANDARD PORT



| Part# | Inlet/Outlet |
|--------|-----------------------|
| 85-14B | 1/4" FNPT x 1/4" FNPT |

FEATURES

Investment cast body and cap.
Teflon® seals & seats for smooth operation & proper seating.
1000 PSI rating (W.O.G.).
-60° to 450° F operating temperature.
Adjustable stem packing.
316 Stainless Steel blow-out proof stem & ball.
Non-locking handle.
1.5" overall length.
One piece body.

CHROMED BRASS ECONOMY LEVER HANDLE



| Part# | Inlet/Outlet | Part# | Inlet/Outlet |
|---------|------------------|---------|------------------|
| MVL18FF | 1/8" FNPT x FNPT | MVL18FM | 1/8" FNPT x MNPT |
| MVL14FF | 1/4" FNPT x FNPT | MVL14FM | 1/4" FNPT x MNPT |
| MVL38FF | 3/8" FNPT x FNPT | MVL38FM | 3/8" FNPT x MNPT |
| MVL12FF | 1/2" FNPT x FNPT | MVL12FM | 1/2" FNPT x MNPT |

FEATURES

Nylon lever handled.
300 PSI rating (CWP).
-4° to 250° F temp. rating.
Chromed brass body, ball & stem.
Teflon® seat and Viton® seals.

CHROMED BRASS ECONOMY BUTTERFLY HANDLE



| Part# | Inlet/Outlet | Part# | Inlet/Outlet |
|---------|------------------|---------|------------------|
| MVT18FF | 1/8" FNPT x FNPT | MVT18FM | 1/8" FNPT x MNPT |
| MVT14FF | 1/4" FNPT x FNPT | MVT14FM | 1/4" FNPT x MNPT |
| MVT38FF | 3/8" FNPT x FNPT | MVT38FM | 3/8" FNPT x MNPT |
| MVT12FF | 1/2" FNPT x FNPT | MVT12FM | 1/2" FNPT x MNPT |

FEATURES

Butterfly t-handle.
300 PSI rating (CWP).
-4° to 250° F temp. rating.
Chromed brass body, ball & stem.
Teflon® seat and Viton® seals.

VALVES

PBV2 SERIES TWO-WAY POLYPROPYLENE

tecomec
AGRICULTURE



FEATURES

Precision molded in glass reinforced polypropylene for strength and chemical resistance.
Teflon® seats for smooth operation and proper sealing characteristics.
EPDM o-rings to handle most fertilizers and many chemicals. Viton® available on request.
Positive handle stops for turning off and on.
Maximum operating pressure 240 PSI for sizes up to 1 1/4", 150 PSI for sizes over 1 1/4".

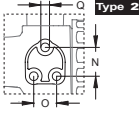
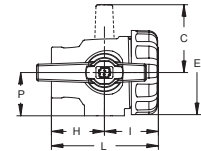
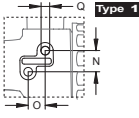
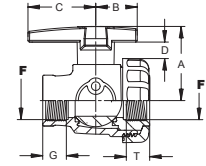

| Part# | FNPT | A | B | C | D | E | G | H | I | L | N | O | P | Q | T |
|----------|--------|-------|-------|-------|------|-------|-------|-------|-------|-------|-------|-------|-------|----|-------|
| PBV2-38 | 3/8" | 2.36" | 1.65" | 1.65" | .62" | 2.32" | .90" | 1.71" | 1.75" | 3.46" | -- | -- | -- | -- | .90" |
| PBV2-12 | 3/4" | 2.36" | 1.65" | 1.65" | .62" | 2.32" | .90" | 1.71" | 1.75" | 3.46" | -- | -- | -- | -- | .90" |
| PBV2-34 | 1/2" | 2.36" | 1.65" | 1.65" | .62" | 2.32" | .90" | 1.71" | 1.75" | 3.46" | -- | -- | -- | -- | .90" |
| PBV2-100 | 1" | 2.87" | 1.65" | 2.08" | .79" | 2.71" | .90" | 1.83" | 2.04" | 3.87" | .98" | .78" | 1.45" | M8 | .98" |
| PBV2-114 | 1 1/4" | 3.15" | 1.65" | 3.03" | .79" | 3.22" | .98" | 2.10" | 2.16" | 4.27" | .98" | .78" | 1.69" | M8 | 1.02" |
| PBV2-112 | 1 1/2" | 3.42" | 1.93" | 3.15" | .79" | 3.89" | 1.10" | 2.46" | 2.50" | 4.96" | 1.33" | 1.06" | 2.00" | M8 | 1.10" |
| PBV2-200 | 2" | 4.33" | 1.93" | 5.11" | .98" | 4.52" | 1.18" | 2.87" | 2.97" | 5.84" | 3.07" | 1.69" | 2.00" | M8 | 1.18" |

PBV3 SERIES THREE-WAY POLYPROPYLENE

tecomec
AGRICULTURE



FEATURES

Precision molded in glass reinforced polypropylene for strength and chemical resistance.
Teflon® seats for smooth operation and proper sealing characteristics.
EPDM o-rings to handle most fertilizers and many chemicals. Viton® available on request.
Positive handle stops for turning off and on.
Maximum operating pressure 240 PSI for sizes up to 1-1/4", 150 PSI for sizes over 1-1/4".
CF notation in the part number stands for Continuous Flow.

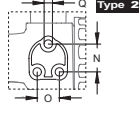
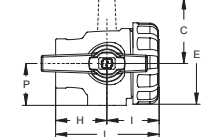
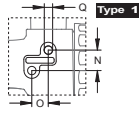
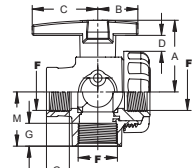

| Part# | FNPT | A | B | C | D | E | G | H | I | L | M | N | O | P | Q | T |
|------------|--------|------|------|------|-----|------|------|------|------|------|------|------|------|------|----|------|
| PBV3-12 | 1/2" | 2.36 | 1.65 | 1.65 | .62 | 2.32 | .90 | 1.71 | 1.75 | 3.46 | 1.65 | -- | -- | -- | -- | .90 |
| PBV3-34 | 3/4" | 2.36 | 1.65 | 1.65 | .62 | 2.32 | .90 | 1.71 | 1.75 | 3.46 | 1.65 | -- | -- | -- | -- | .90 |
| PBV3-100 | 1" | 2.87 | 1.65 | 2.08 | .78 | 2.71 | .90 | 1.83 | 2.04 | 3.87 | 1.85 | .98 | .78 | 1.45 | M8 | .98 |
| PBV3-100CF | 1" | 2.87 | 1.65 | 2.08 | .78 | 2.71 | .90 | 1.83 | 2.04 | 3.87 | 1.85 | .98 | .78 | 1.45 | M8 | .98 |
| PBV3-114 | 1 1/4" | 3.15 | 1.65 | 3.03 | .78 | 3.22 | .98 | 2.10 | 2.16 | 4.27 | 2.10 | .98 | .78 | 1.69 | M8 | 1.02 |
| PBV3-112 | 1 1/2" | 3.42 | 1.92 | 3.14 | .78 | 3.89 | 1.10 | 2.46 | 2.50 | 4.96 | 2.59 | 1.33 | 1.06 | 2.00 | M8 | 1.10 |
| PBV3-112CF | 1 1/2" | 3.42 | 1.92 | 3.14 | .78 | 3.89 | 1.10 | 2.46 | 2.50 | 4.96 | 2.59 | 1.33 | 1.06 | 2.00 | M8 | 1.10 |
| PBV2-200 | 2" | 4.33 | 1.92 | 5.11 | .98 | 4.52 | 1.18 | 2.87 | 2.97 | 5.84 | 3.18 | 3.07 | 1.69 | 2.00 | M8 | 1.18 |

BALL VALVES

MNPTxHB VALVES POLYPROPYLENE



| Part# | Connection Size |
|----------------|---------------------------------------|
| PBV-38HB12 | 1/2" MNPT x 3/8" HB 150 PSI Max, 2 Pk |
| PBV-38HB12-CSK | Same as above w/clamshell packaging |

HBxHB VALVES POLYPROPYLENE



| Part# | Connection Size |
|--------------|-------------------------------------|
| PBV-38HB | 3/8" HB x 3/8" HB 150 PSI Max, 2 Pk |
| PBV-38HB-CSK | Same as above w/clamshell packaging |

FNPTxFNPT BOLTED



| Part# | Connection Size | # of Bolts |
|--|-----------------|------------|
| BLTBV-204-BC | 2" | 4 |
| BLTBV-206-BC | 2" | 6 |
| BLTBV-300-BC | 3" | |
| Other Sizes Available. Call For Details. | | |

FNPTxFNPT TWO-WAY ZINC PLATED



| Part# | Connection Size | GPM |
|--------------|-------------------|-------|
| 8109.2601.00 | 1/4" FPT x 1/4" F | 2.64 |
| 8109.2602.00 | 3/8" FPT x 3/8" F | 6.60 |
| 8109.2603.00 | 1/2" FPT x 1/2" F | 10.57 |

| FEATURES | |
|----------------|---------------------|
| Operating Temp | 212 °F |
| Material | Chrome Plated Steel |
| PSI Rating | 7400 Max |
| Handle Type | Steel, Bent |

FNPTxFNPT TWO-WAY ZINC PLATED



| Part# | Connection Size |
|--------------|-----------------|
| 8402.2611.00 | 1 1/4" |
| 8402.2612.00 | 1 1/2" |

| FEATURES | |
|----------------|-------------------|
| Operating Temp | 212 °F |
| Material | Zinc Plated Steel |
| PSI Rating | 5000 Max |
| Handle Type | Steel, Bent |

FNPTxFNPT THREE-WAY ZINC PLATED



| Part# | Connection Size |
|--------------|-----------------|
| 8402.2622.00 | 1 1/4" |
| 8402.2628.00 | 1 1/2" |
| 8402.2629.00 | 2" |

| FEATURES | |
|----------------|-------------------|
| Operating Temp | 212 °F |
| Material | Zinc Plated Steel |
| PSI Rating | 5000 Max |
| Handle Type | Steel, Bent |



CLAMPS ^{T-BOLT}



PURPOSE

To provide a quick, yet effective means of clamping a variety of fittings to a wide range of hose. T-Bolts can be applied with a standard socket wrench. They provide 360° sealing surface by using a shoe or formed bridge. Bag quantities of 50.

| Part# | Nominal | From | To |
|-----------|---------|----------|----------|
| TB-840150 | 1-1/2" | 1-3/8" | 1-9/16" |
| TB-840175 | 1-3/4" | 1-5/8" | 1-13/16" |
| TB-840200 | 2" | 1-7/8" | 2-1/16" |
| TB-840225 | 2-1/4" | 2-1/8" | 2-5/16" |
| TB-840238 | 2-3/8" | 2-1/4" | 2-7/16" |
| TB-840250 | 2-1/2" | 2-3/8" | 2-9/16" |
| TB-840275 | 2-3/4" | 2-17/32" | 2-13/16" |
| TB-840300 | 3" | 2-25/32" | 3-1/16" |
| TB-840325 | 3-1/4" | 3-1/32" | 3-5/16" |
| TB-840350 | 3-1/2" | 3-9/32" | 3-9/16" |
| TB-840375 | 3-3/4" | 3-17/32" | 3-16/16" |
| TB-840425 | 4-1/4" | 4-1/32" | 4-5/16" |
| TB-840450 | 4-1/2" | 4-9/32" | 4-9/16" |
| TB-840475 | 4-3/4" | 4-17/32" | 4-13/16" |

FEATURES

- 0.025" band thickness
- 3/4" wide band
- Self locking nuts
- 75 in/lb torque rating
- Bag Quantity: 50

SERVICES

The T-Bolt clamp is a high strength, reliable clamp with numerous applications in both the commercial and industrial markets including hose and duct work connections for air, oil, water and other types of low pressure fluid lines.

CLAMP ^{PIPE}



| Part# | Pipe ID |
|---------|---------|
| CPC-100 | 1" |

Use with Schedule 80 Polypropylene pipe.

ANCHOR ^{BRACKET}



| Part# | Description |
|--------|---------------|
| TD-150 | 1.5" Tie down |
| TD-200 | 2" Tie down |

Tank tie down strap, anchor bracket 2"

SEALANT ^{PIPE}



| Part# | Size |
|-------|-------------------------------|
| 25790 | #5 Rectorseal, 1.75 oz. tube |
| 25631 | #5 Rectorseal, 1/4 pint can |
| 25551 | #5 Rectorseal, 1/2 pint can |
| 25431 | #5 Rectorseal, 1 pint can |
| 28651 | # 21 Rectorseal, 1/2 pint can |
| 28541 | # 21 Rectorseal, 1 pint can |

SEALANT ^{TAPE} PTFE



| Part# | Width/Length | #/box |
|----------|--------------|-------|
| 12-60 | 1/2" by 60" | 100 |
| 12-260 | 1/2" by 260" | 100 |
| 12-520 | 1/2" by 520" | 100 |
| 34-520 | 3/4" by 520" | 100 |
| 100-1296 | 1" by 1296" | 150 |



MNPTxMNPT LOW PROFILE NYLON

| Nylon Bowl | | | | Clear Bowl | | | |
|------------|------|--------|------|------------|------|--------|------|
| Part# | Size | Gasket | Mesh | Part# | Size | Gasket | Mesh |
| 14644 | ¼" | EPDM | 20 | 14656 | ¼" | EPDM | 20 |
| 11474 | ¼" | EPDM | 40 | 11633 | ¼" | EPDM | 40 |
| 12992 | ¼" | EPDM | 80 | 11469 | ¼" | EPDM | 80 |
| 17933 | ¼" | Viton | 20 | 10910 | ¼" | Viton | 20 |
| 11215 | ¼" | Viton | 40 | 10911* | ¼" | Viton | 40 |
| 11043 | ¼" | Viton | 80 | 10912* | ¼" | Viton | 80 |
| 17934 | ½" | EPDM | 20 | 12379 | ½" | EPDM | 20 |
| 12546 | ½" | EPDM | 40 | 11434 | ½" | EPDM | 40 |
| 12815 | ½" | EPDM | 80 | 13090 | ½" | EPDM | 80 |
| 11109 | ½" | Viton | 20 | 10924 | ½" | Viton | 20 |
| 12171 | ½" | Viton | 40 | 10925 | ½" | Viton | 40 |
| 10923 | ½" | Viton | 80 | 10981 | ½" | Viton | 80 |

*Available with FPT Connections

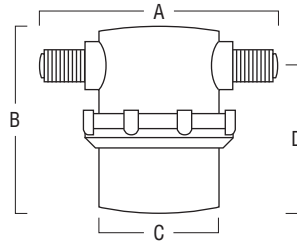

| Dimensions | |
|-------------|----------|
| A | 3.06" |
| B | 2.42" |
| C | 1.86" |
| D | 1.98" |
| Filter Area | 4.27 sq" |



MNPTxMNPT LOW PROFILE POLYPROPYLENE

| Polypropylene Bowl | | | | Clear Bowl | | | |
|--------------------|------|--------|------|------------|------|--------|------|
| Part# | Size | Gasket | Mesh | Part# | Size | Gasket | Mesh |
| 17912 | ¼" | EPDM | 20 | 14628 | ¼" | EPDM | 20 |
| 11642 | ¼" | EPDM | 40 | 14629 | ¼" | EPDM | 40 |
| 14591 | ¼" | EPDM | 80 | 14630 | ¼" | EPDM | 80 |
| 17913 | ¼" | Viton | 20 | 17916 | ¼" | Viton | 20 |
| 13914 | ¼" | Viton | 40 | 12326 | ¼" | Viton | 40 |
| 13915 | ¼" | Viton | 80 | 12678 | ¼" | Viton | 80 |
| 17917 | ½" | EPDM | 20 | 14637 | ½" | EPDM | 20 |
| 17918 | ½" | EPDM | 40 | 12250 | ½" | EPDM | 40 |
| 17919* | ½" | EPDM | 80 | 12397 | ½" | EPDM | 80 |
| 17920 | ½" | Viton | 20 | 18456 | ½" | Viton | 20 |
| 17921 | ½" | Viton | 40 | 17923 | ½" | Viton | 40 |
| 17922 | ½" | Viton | 80 | 12410 | ½" | Viton | 80 |

*Available with FPT Connections

STRAINERS



FNPTxFNPT STANDARD NYLON

Nylon Bowl

| Part# | Size | Gasket | Mesh |
|-------|------|--------|------|
| 11407 | 1/2" | EPDM | 40 |
| 11297 | 3/4" | EPDM | 20 |
| 11298 | 3/4" | EPDM | 40 |
| 11300 | 3/4" | EPDM | 80 |
| 10962 | 3/4" | Viton | 80 |

Clear Bowl

| Part# | Size | Gasket | Mesh |
|-------|------|--------|------|
| 17935 | 1/2" | EPDM | 20 |
| 17936 | 1/2" | EPDM | 40 |
| 12553 | 1/2" | EPDM | 80 |
| 10949 | 1/2" | Viton | 40 |
| 10946 | 1/2" | Viton | 80 |
| 12460 | 3/4" | EPDM | 20 |
| 11299 | 3/4" | EPDM | 40 |
| 11301 | 3/4" | EPDM | 80 |
| 10985 | 3/4" | Viton | 40 |
| 10986 | 3/4" | Viton | 80 |

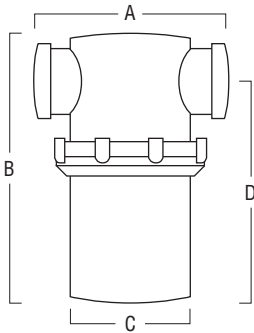

Dimensions

| Size | A | B | C | D | F. Area |
|------|-------|-------|-------|-------|---------|
| 1/2" | 3.64" | 5.35" | 2.95" | 4.80" | 19 sq" |
| 3/4" | 3.64" | 5.35" | 2.95" | 4.80" | 19 sq" |

FNPTxFNPT STANDARD POLYPROPYLENE

Polypropylene Bowl

| Part# | Size | Gasket | Mesh |
|----------|------|--------|------|
| 14577 | 1/2" | EPDM | 20 |
| 11354 | 1/2" | EPDM | 40 |
| 11385 | 1/2" | EPDM | 80 |
| 12375 | 1/2" | Viton | 40 |
| 17924 | 1/2" | Viton | 80 |
| 11262 | 3/4" | EPDM | 20 |
| 11263 | 3/4" | EPDM | 40 |
| 11264 | 3/4" | EPDM | 80 |
| 11264-BC | 3/4" | EPDM | 80 |
| 12573 | 3/4" | Viton | 20 |
| 11376 | 3/4" | Viton | 40 |
| 11277 | 3/4" | Viton | 80 |

Clear Bowl

| Part# | Size | Gasket | Mesh |
|-------|------|--------|------|
| 14687 | 1/2" | EPDM | 20 |
| 12356 | 1/2" | EPDM | 40 |
| 14688 | 1/2" | EPDM | 80 |
| 17925 | 1/2" | Viton | 20 |
| 17926 | 1/2" | Viton | 40 |
| 13752 | 1/2" | Viton | 80 |
| 14689 | 3/4" | EPDM | 20 |
| 12262 | 3/4" | EPDM | 40 |
| 14466 | 3/4" | EPDM | 80 |
| 17927 | 3/4" | Viton | 20 |
| 17928 | 3/4" | Viton | 40 |
| 14323 | 3/4" | Viton | 80 |



-BC Suffix Denotes Product is Offered with Barcoding





| Nylon Bowl | | | | Clear Bowl | | | |
|------------|------|--------|------|------------|------|--------|------|
| Part# | Size | Gasket | Mesh | Part# | Size | Gasket | Mesh |
| 11303 | 1" | EPDM | 20 | 14674 | 1" | EPDM | 20 |
| 11304 | 1" | EPDM | 40 | 12165 | 1" | EPDM | 40 |
| 11305 | 1" | EPDM | 80 | 12324 | 1" | EPDM | 80 |
| 10999 | 1" | Viton | 20 | 11005 | 1" | Viton | 20 |
| 11001 | 1" | Viton | 40 | 11007 | 1" | Viton | 40 |
| 11002 | 1" | Viton | 80 | 11003 | 1" | Viton | 80 |
| 17938 | 1¼" | EPDM | 20 | 13716 | 1¼" | EPDM | 20 |
| 11308 | 1¼" | EPDM | 40 | 12166 | 1¼" | EPDM | 40 |
| 11309 | 1¼" | EPDM | 80 | 12430 | 1¼" | EPDM | 80 |
| 11021 | 1¼" | Viton | 20 | 11026 | 1¼" | Viton | 20 |
| 11023 | 1¼" | Viton | 40 | 11028 | 1¼" | Viton | 40 |
| 11019 | 1¼" | Viton | 80 | 11024 | 1¼" | Viton | 80 |
| 17939 | 1½" | EPDM | 20 | 11538 | 1½" | EPDM | 20 |
| 11606 | 1½" | EPDM | 40 | 12138 | 1½" | EPDM | 40 |
| 11528 | 1½" | EPDM | 80 | 12325 | 1½" | EPDM | 80 |
| 11432 | 1½" | Viton | 20 | 11145 | 1½" | Viton | 20 |
| 11360 | 1½" | Viton | 40 | 11054 | 1½" | Viton | 40 |
| 11518 | 1½" | Viton | 80 | 11186 | 1½" | Viton | 80 |

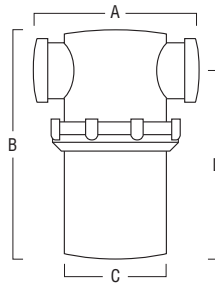

| Dimensions | | | | | |
|------------|-------|-------|-------|-------|--------|
| Size | A | B | C | D | F.Area |
| 1" | 4.62" | 6.36" | 4.00" | 5.60" | 33 sq" |
| 1¼" | 5.00" | 7.10" | 4.00" | 6.10" | 36 sq" |
| 1½" | 5.16" | 8.10" | 4.00" | 6.93" | 39 sq" |



| Polypropylene Bowl | | | | Clear Bowl | | | |
|--------------------|------|--------|------|------------|------|--------|------|
| Part# | Size | Gasket | Mesh | Part# | Size | Gasket | Mesh |
| 11265 | 1" | EPDM | 20 | 12943 | 1" | EPDM | 20 |
| 11266* | 1" | EPDM | 40 | 12488 | 1" | EPDM | 40 |
| 11267* | 1" | EPDM | 80 | 12465 | 1" | EPDM | 80 |
| 12338 | 1" | Viton | 20 | 17929 | 1" | Viton | 20 |
| 11378 | 1" | Viton | 40 | 17930 | 1" | Viton | 40 |
| 12336 | 1" | Viton | 80 | 14915 | 1" | Viton | 80 |
| 11268 | 1¼" | EPDM | 20 | 13740 | 1¼" | EPDM | 20 |
| 11269 | 1¼" | EPDM | 40 | 12415 | 1¼" | EPDM | 40 |
| 11270* | 1¼" | EPDM | 80 | 12389 | 1¼" | EPDM | 80 |
| 17637 | 1¼" | Viton | 20 | 17741 | 1¼" | Viton | 20 |
| 11379 | 1¼" | Viton | 40 | 17931 | 1¼" | Viton | 40 |
| 12337 | 1¼" | Viton | 80 | 14916 | 1¼" | Viton | 80 |
| 11271-VI | 1½" | EPDM | 20 | 13850 | 1½" | EPDM | 20 |
| 11272* | 1½" | EPDM | 40 | 14460 | 1½" | EPDM | 40 |
| 11273 | 1½" | EPDM | 80 | 14464 | 1½" | EPDM | 80 |
| 12572 | 1½" | Viton | 20 | 17932 | 1½" | Viton | 20 |
| 11380 | 1½" | Viton | 40 | 13539 | 1½" | Viton | 40 |
| 11381 | 1½" | Viton | 80 | 13751 | 1½" | Viton | 80 |

*Product is available with barcoding. Add -BC suffix to end of part #.

STRAINERS



« SUCTION STRAINERS



| Part# | Connection Size | Mesh |
|-------|-----------------|---------|
| 10403 | 3/8" Barb | 50 x 50 |
| 10416 | 3/8" FNPT | 40 x 36 |
| 10421 | 1/2" FNPT | 40 x 30 |
| 11071 | 3/4" NPT | 20 x 20 |

Mushroom Style

« O-RINGS/SCREENS FOR STRAINERS

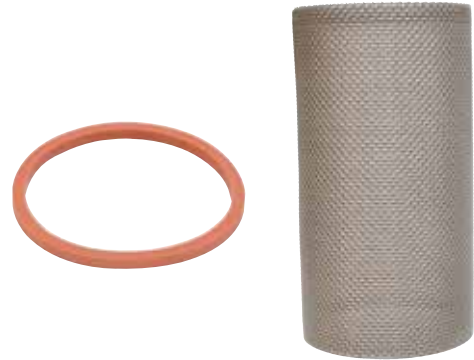

| Part# | Description |
|-------------|--|
| 11302-CSK | EPDM O-Ring for 3/4" Strainer, Clamshelled |
| 11306-VI | EPDM O-Ring for 1" or 1.5" Nylon Strainers |
| 10523-VI | 1" Strainer Screen 50 Mesh |
| 10523-VI-BC | 1" Strainer Screen 50 Mesh, Barcoded |
| 10524-BC | 1" 124A Strainer Screen, 80 Mesh, Barcoded |
| 10849-BC | 1 1/2" Line Strainer Screen, 50 Mesh, Barcoded |
| 10866-VI | 1 1/2" Line Strainer Screen, 20x20, Stainless |

« CLASS 800 Y-STRAINER



| Part# | FNPT | L | A | H |
|-----------|--------|-------|-------|-------|
| 316-YS38 | 3/8" | 2.559 | 0.748 | 1.811 |
| 316-YS12 | 1/2" | 2.559 | 0.748 | 1.811 |
| 316-YS34 | 3/4" | 3.150 | 0.905 | 2.283 |
| 316-YS112 | 1 1/2" | 4.724 | 1.614 | 3.346 |

FEATURES

- Investment Cast Body
- 800 PSI maximum pressure
- 230° F maximum working temperature

« FNPT PIPE POLYPROPYLENE



| Part# | NPT |
|-----------|-----------------------------------|
| 075-8-00P | 3/4" no spacing |
| 075-8-10P | 3/4" with 10" spacing, 3/8" holes |
| 075-8-20P | 3/4" with 20" spacing, 3/8" holes |
| 100-8-00P | 1" no spacing |
| 100-8-10P | 1" with 10" spacing, 3/8" holes |
| 100-8-20P | 1" with 20" spacing, 3/8" holes |

Schedule 80, Black. 20 Foot lengths standard



WHEEL & TIRE

PRESSURE RELIEF VALVES



| Part# | PSI | Inlet (MNPT) |
|------------------|---------|-------------------|
| RV2064-01-58 | 150 Max | 1/2" |
| RV2064-06-58 | 400 Max | 1/2" |
| RV2064-06-58-CSK | 400 Max | 1/2", Clamshelled |
| RV2066-01-58 | 150 Max | 3/4" |
| RV2066-05-58 | 250 Max | 3/4" |
| RV2066-06-58 | 400 Max | 3/4" |
| RV2066-05-58-CSK | 400 Max | 3/4", Clamshelled |

FEATURES

3/4" FNPT discharge
Polypropylene & Brass Construction



| Part# | PSI |
|-----------|---------|
| RV34-300B | 300 Max |
| RV34-700B | 700 Max |

FEATURES

3/4" MNPT inlet
Solid brass construction

| Part# | PSI |
|---------------|---------|
| RV12-700B-CSK | 700 Max |

FEATURES

1/2" MNPT inlet
Solid brass construction



| Part# | PSI |
|-----------|---------|
| RV34-300A | 300 Max |

FEATURES

3/4" MNPT inlet
Aluminum construction

FUEL TRANSFER GUN

3/4" HB INLET



| Part# | Description |
|-----------|---------------------------------|
| DN-506530 | Polypropylene Fuel Transfer Gun |

FEATURES

| | |
|-------------|----------------------------------|
| Non-Locking | Stainless Spring |
| 150 PSI Max | 3/4" Hose Barb Connection |
| 40 GPM | Viton Pin Bushing & Rubber Parts |

10", FOAM FILLED TIRE ASSEMBLY



| | |
|---------------------|--|
| Part # | TWA410/350-4-PU TWA410/350-4-PU-BC (Barcoded) |
| Description | 10" Polyurethane Filled Tire & Wheel |
| Size | 410/350-4 |
| Tread | 2-ply 'Turf Tread' |
| Bearing ID | 5/8" ID |
| Ball Bearing | Steel |
| Rim Size | 4" Diameter |
| Tread Width | 2-5/8" |
| Hub Width | 2-1/4" |
| Load Rating | 400 lbs |

ASSEMBLIES

PNEUMATIC 10" & 13"



| Part # | TWA410/350-4 | TWA13X5-6 |
|---------------------|--------------------|--------------------|
| Description | 10" Tire & Wheel | 13" Tire & Wheel |
| Size | 410/350-4 | 13.0 X 5.00 -6.00 |
| Tread | 2-ply 'Turf Tread' | 2-ply 'Turf Tread' |
| Bearing ID | 5/8" ID | 3/4" ID |
| Ball Bearing | Steel | Steel |
| Rim Size | 4" Diameter | 6 3/8" Diameter |
| Tread Width | 2-5/8" | 4" |
| Hub Width | 2-1/4" | 2-1/4" |
| Load Rating | 265 lbs | 330 lbs |

PNEUMATIC 15"



| Part # | Description |
|---|---------------------------|
| TWA15x600-6 | 15" Tire & Wheel Assembly |
| FEATURES  | |
| 2-ply Tires With 'Turf Tread' | |
| 3/4" ID Steel Ball Bearing | |
| 6" Rim | |
| 4-1/2" Tread Width | |
| 3-1/8" Hub Width | |
| Load Rating: 396 lbs | |

PNEUMATIC 18"



| Part # | Description |
|---|-----------------------------|
| TWA-16x6.5-8/4-HOLE | 18" Tire and Wheel Assembly |
| FEATURES  | |
| 4-ply Tires | |
| 4 Hole Bolt Pattern with 4" Spacing | |
| 9" Rim | |
| 7" Tread Width | |
| Max Load 785 lbs. at 26 PSI | |

HEAVY DUTY POLYMER 12"



| Part # | Description |
|---|--|
| TWA12x1.75-1/2 | 12" Wheel Assembly. Replacement wheel for PCD-E3-009B-MM |
| FEATURES  | |
| Solid Polymer Tires | |
| 3/4" ID Steel Ball Bearing | |
| Chemical Resistant Polymer Rim | |
| 2" Tread Width | |
| Solid 5 Spoke Zero PSI Wheel | |

FRAME KITS

Visit www.master-mfg.com for more info.



**FOR 2" RECEIVERS
10 POSITIONS**



UNIVERSAL BOOM MOUNT

| Part# | FEATURES |
|------------|---|
| SSFK-UTVBR | Adjustable self-leveling positions Tension locking system for snug fit in receiver Tool free installation Universal setup for Master Mfg spray booms |

QUICK ATTACH ATV BOOM MOUNTING KIT 15-25 GALLON



| Part# | FEATURES |
|-------------|--|
| SSFK-ATV-QA | Converts spot sprayer to ATV sprayer Spring-loaded mounts for perfect spray height Installs at bottom of 15 & 25 gallon tanks Includes two ratchet straps |

NEW DIRECTION TRAILER KIT 15-25 GALLON



| Part# | FEATURES |
|-------------|---|
| SSFK-1525ND | All steel design. Foam-filled, never flat tires. Folding tongue for compact storage. |

BOOM KITS

ALL FRAME & BOOM KITS ARE PACKAGED IN FULL-COLOR, BARCODED, RETAIL-READY BOXES!



Part#

SSBK-240

FEATURES

- Dual, quick-attach deflector nozzles
- Pressure regulating system with 100 PSI gauge
- Adjustable brackets for the perfect spray height
- Compact design to prevent damage from obstacles
- 1.8 GPM required
- Includes 12V wire harness with power switch
- Compatible with Master MFG mounting kits



Part#

SSBK-420

FEATURES

- Four, quick-attach flat fan nozzles
- Pressure regulating system with 100 PSI gauge
- Adjustable brackets for the perfect spray height
- Folding wings for compact storage
- 1.8 GPM required
- Includes 12V wire harness with power switch
- Compatible with Master MFG mounting kits



Part#

SSBK-340

FEATURES

- Three, quick-attach deflector nozzles
- Pressure regulating system with 100 PSI gauge
- Adjustable brackets for the perfect spray height
- Folding wings for compact storage
- 1.8 GPM required
- Includes 12V wire harness with power switch
- Compatible with Master MFG mounting kits



Part#

SSBK-620

FEATURES

- Six, quick-attach flat fan nozzles
- Pressure regulating system with 100 PSI gauge
- Adjustable brackets for the perfect spray height
- Folding wings for compact storage
- 1.8 GPM required
- Includes 12V wire harness with power switch
- Compatible with Master MFG mounting kits

BOOM

Visit www.master-mfg.com for more info.

13' COVERAGE BOOM KIT FOLDING, 8-NOZZLE

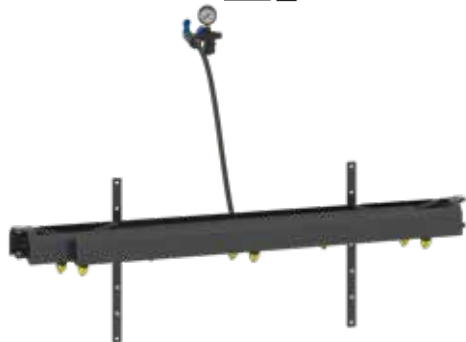

Part#

SSBK-820

FEATURES

- Eight, quick-attach flat fan nozzles
- Pressure regulating system with 100 PSI gauge
- Adjustable brackets for the perfect spray height
- Folding wings for compact storage
- 2.2 GPM required
- Includes 12V wire harness with power switch
- Compatible with Master MFG mounting kits

30' COVERAGE BOOM KIT PRECISION & BROADCAST



Part#

SSBK-PNB

Description

Up to 30' Coverage with Broadcast Nozzles and Precision Spraying with 3 Flat Fan Nozzles



Go from precision spraying with flat fan nozzles to broadcast spraying using boomless nozzles, with a simple twist of the outer assemblies. The center precision assembly includes an easy on/off knob.

23' COVERAGE CHAIN BOOM KIT FOLDING, 14-NOZZLE

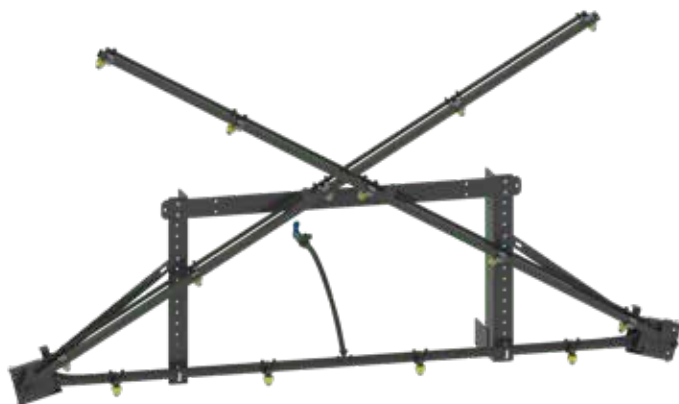

Part#

SSBK-1420

FEATURES

- Fourteen, quick-attach flat fan nozzles.
- Pressure regulating system with 100 PSI gauge.
- Adjustable brackets for the perfect spray height.
- Chain supported arms that fold-in for compact storage.
- 5.0 GPM pump required.

KITS

16' COVERAGE BOOMLESS NOZZLE KIT



Part#

SSBK-NB-2

FEATURES

- Single boomless nozzle
- Pressure regulating system with 100 PSI gauge
- Adjustable brackets for the perfect spray height
- Compact design to avoid obstacles
- 1.8+ GPM required
- Includes 12V wire harness with power switch
- Compatible with Master MFG mounting kits

16-22' COVERAGE BOOMLESS NOZZLE KIT



Part#

SSBK-DNB-2

Coverage

16'

GPM

2.0

SSBK-DNB-3

22'

3.0

FEATURES

- Dual boomless nozzles
- Pressure regulating system with 100 PSI gauge
- Adjustable brackets for the perfect spray height
- Compact design to avoid obstacles
- Includes 12V wire harness with power switch
- Compatible with Master MFG mounting kit

CENTER TWIST NOZZLE BODY FOR SSBK-PNB



Part#

G-8234084-CSK

Description

Center Nozzle Body for the SSBK-PNB.

OUTER TWIST NOZZLE BODY FOR SSBK-PNB



Part#

G-8244190-KIT-CSK

Description

Outer Twist Nozzle Body Assembly for the SSBK-PNB.



EVERFLO

Visit www.everflopump.com for more info.



DIAPHRAGM PUMP REPLACEMENT HEAD KITS



| Part# | Port Size | Part# | GPM |
|------------|-----------|---------------|-----|
| EF2200-KIT | 3/8" | EF2200-QA-KIT | 2.2 |
| EF3000-KIT | 1/2" | EF3000-QA-KIT | 3.0 |
| EF4000-KIT | 1/2" | EF4000-QA-KIT | 4.0 |
| EF5500-KIT | 1/2" | EF5500-QA-KIT | 5.5 |
| EF7000-KIT | 1/2" | EF7000-QA-KIT | 7.0 |

INCLUDES

Pump Head (NPT or QA) Diaphragm
Valve Plate Pressure Switch
All kits are packaged in full color, retail ready boxes.

DIAPHRAGM PUMP QUICK ATTACH PORTS

1.1 GPM



| Part# | Port Type | Packaging |
|--------------|--------------|-----------|
| EF1100-QA | Quick Attach | Bulk |
| EF1100-QA-BC | Quick Attach | Barcoded |

FEATURES

| | |
|-------------|--|
| 40 PSI | Polypropylene Pump Housing & Valve Plate |
| 4 Max Amps | Zinc Plated Steel Fasteners |
| 1.3 lbs Dry | Self Priming to 4' |
| CE Approved | Painted Steel 2" Motor Shell |
| | 140° F Max Temperature Rating |

DIAPHRAGM PUMP QA OR NPT PORTS

2.0 GPM ECONOMY



| Part# | Port Type | Packaging |
|------------|--------------|-----------|
| EF200EQ | Quick Attach | Bulk |
| EF200EQ-BC | Quick Attach | Barcoded |
| EF200E | 3/8" FNPT | Bulk |
| EF200E-BC | 3/8" FNPT | Barcoded |

FEATURES

| | |
|-------------|--|
| 70 PSI | Polypropylene Pump Housing & Valve Plate |
| 8 Max Amps | Zinc Plated Steel Fasteners |
| 4.8 lbs Dry | Self Priming to 8' |
| CE Approved | Painted Steel 3" Motor Shell |
| | 140° F Max Temperature Rating |

PUMPS

DIAPHRAGM PUMP ^{1.0 GPM} HOSE BARB PORTS



| Part# | Port Type | Packaging |
|------------|----------------|-----------|
| EF1000 | 3/8" Hose Barb | Bulk |
| EF1000-BC | 3/8" Hose Barb | Barcoded |
| EF1000-BOX | 3/8" Hose Barb | Boxed |

1.0 GPM pumps are not user serviceable.

FEATURES

| | |
|-------------|--|
| 40 PSI | Polypropylene Pump Housing & Valve Plate |
| 4 Max Amps | Zinc Plated Steel Fasteners |
| 1.3 lbs Dry | Self Priming to 4' |
| CE Approved | Painted Steel 2" Motor Shell |
| | 140° F Max Temperature Rating |

DIAPHRAGM PUMP ^{2.2 GPM} NPT OR QA PORTS



| Part# | Port Type | Packaging |
|---------------|--------------|-----------|
| EF2200-QA | Quick Attach | Bulk |
| EF2200-QA-BOX | Quick Attach | Boxed |
| EF2200 | 3/8" FNPT | Bulk |
| EF2200-BC | 3/8" FNPT | Barcoded |
| EF2200-BOX | 3/8" FNPT | Boxed |

FEATURES

| | |
|-----------------|--|
| 70 PSI | Polypropylene Pump Housing & Valve Plate |
| 8 Max Amps | Zinc Plated Steel Fasteners |
| 4.8 lbs Dry | Self Priming to 8' |
| CE Approved | Painted Steel 3" Motor Shell |
| 140° F Max Temp | Replacement Heads: EF2200-KIT & EF2200-QA-KIT |

DIAPHRAGM PUMP ^{3.0 GPM} NPT OR QA PORTS



| Part# | Port Type | Packaging |
|---------------|--------------|-----------|
| EF3000-QA | Quick Attach | Bulk |
| EF3000-QA-BOX | Quick Attach | Boxed |
| EF3000 | 1/2" FNPT | Bulk |
| EF3000-BC | 1/2" FNPT | Barcoded |
| EF3000-BOX | 1/2" FNPT | Boxed |

FEATURES

| | |
|-----------------|--|
| 60 PSI | Polypropylene Pump Housing & Valve Plate |
| 10 Max Amps | Zinc Plated Steel Fasteners |
| 5.6 lbs Dry | Self Priming to 12' |
| CE Approved | Painted Steel 3" Motor Shell |
| 140° F Max Temp | Replacement Heads: EF3000-KIT & EF3000-QA-KIT |

DIAPHRAGM PUMP ^{4.0 GPM} NPT OR QA PORTS



| Part# | Port Type | Packaging |
|---------------|--------------|-----------|
| EF4000-QA | Quick Attach | Bulk |
| EF4000-QA-BOX | Quick Attach | Boxed |
| EF4000 | 1/2" FNPT | Bulk |
| EF4000-BC | 1/2" FNPT | Barcoded |
| EF4000-BOX | 1/2" FNPT | Boxed |

FEATURES

| | |
|-----------------|--|
| 60 PSI | Polypropylene Pump Housing & Valve Plate |
| 13 Max Amps | Zinc Plated Steel Fasteners |
| 5.6 lbs Dry | Self Priming to 12' |
| CE Approved | Painted Steel 3" Motor Shell |
| 140° F Max Temp | Replacement Heads: EF4000-KIT & EF4000-QA-KIT |

EVERFLO

PUMPS

5.5 GPM

DIAPHRAGM PUMP

NPT OR QA PORTS



| Part# | Port Type | Packaging |
|---------------|--------------|-----------|
| EF5500-QA | Quick Attach | Bulk |
| EF5500-QA-BOX | Quick Attach | Boxed |
| EF5500 | 1/2" FNPT | Bulk |
| EF5500-BC | 1/2" FNPT | Barcoded |
| EF5500-BOX | 1/2" FNPT | Boxed |

FEATURES

| | |
|-----------------|--|
| 60 PSI | Polypropylene Pump Housing & Valve Plate |
| 17 Max Amps | Zinc Plated Steel Fasteners |
| 5.6 lbs Dry | Self Priming to 12' |
| CE Approved | Painted Steel 3" Motor Shell |
| 140° F Max Temp | Replacement Heads: EF5500-KIT & EF5500-QA-KIT |

7.0 GPM

DIAPHRAGM PUMP

NPT OR QA PORTS



| Part# | Port Type | Packaging |
|---------------|--------------|-----------|
| EF7000-QA-BOX | Quick Attach | Bulk |
| EF7000-BOX | 1/2" FNPT | Boxed |

FEATURES

| | |
|-----------------|--|
| 60 PSI | Polypropylene Pump Housing & Valve Plate |
| 23 Max Amps | Zinc Plated Steel Fasteners |
| 9.5 lbs Dry | Self Priming to 12' |
| CE Approved | Painted Steel 5" Motor Shell |
| 140° F Max Temp | Replacement Heads: EF7000-KIT & EF7000-QA-KIT |

1.5 GPM HIGH PRESSURE

DIAPHRAGM PUMP

NPT OR QA PORTS



| Part# | Port Type | Packaging |
|----------------|--------------|-----------|
| EFHP1515QA-BOX | Quick Attach | Boxed |
| EFHP1515-BOX | 3/8" FNPT | Boxed |

FEATURES

| | |
|---------------|-------------------------------|
| 150 PSI | Self Priming to 8' |
| 10.5 Max Amps | Auto Shut-Off |
| 5.0 lbs Dry | 140° F Max Temperature Rating |
| CE Approved | |

2.0 GPM HIGH PRESSURE

DIAPHRAGM PUMP

QA PORTS



| Part# | Description |
|--------------|----------------------------------|
| EFHP2000-BOX | 2.0 GPM 12V Plunger Pump - Boxed |

FEATURES

| | |
|-------------|-------------------------------|
| 200 PSI | Ceramic Coated Plunger |
| 20 Max Amps | Auto Shut-Off |
| 13 lbs Dry | QA Ports Only |
| CE Approved | Includes 6 Common Fittings |
| | 140° F Max Temperature Rating |

HOSE & ACCESSORIES

CUSTOMIZABLE VALVE BANKS



| Part# | Description |
|-------------|---|
| G-8372C0070 | A variety of sizes and style Valve Banks are available to control individual sections of large booms independently. Call for details. |

RUBBER HOSE CLAMSHELLED



| Part# | Description |
|-------------|---|
| 38RUB15-CSK | 15' of 3/8" Hose with Clamshell Packaging |
| 33-103622 | Bulk 1/2" Hose |

HIGH PRESSURE HOSE

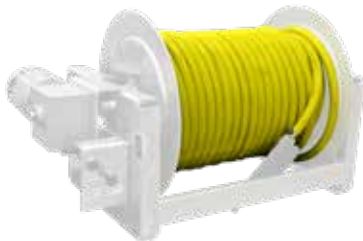

| Part # | Length | Pressure | Size |
|-----------------|--------|----------------|------|
| 33-103321-150FT | 150' | 600 PSI Max | 1/2" |
| 33-103321-200FT | 200' | | |
| 33-103321-300FT | 300' | | |

NYLON HOSE CLEAR



| Part# | Inner Diameter | Outer Diameter |
|-----------|----------------|----------------|
| 33-103938 | .37" | .59" |

BYPASS KIT



| Part# | Description |
|---------------|--|
| 34-140028-CSK | Bypass Kit includes two-way shut off valve, hose and connections |

HOSE REPAIR KIT HBxHB



| Part# | Description |
|---------------|--|
| 34-140024-CSK | Features 3/8" hose barbs and connection to mend damaged hose |

HOSE ACCESSORIES

SET SCREW COUPLER STEEL



Part#

50101-1

FEATURES

Fits 4 Roller Pump For 5/8" Diameter Motors
2600 RPM Max Steel Construction

GHT SHUT-OFF VALVE NYLON



Part#

Connection Size

GHV-1-BLK 3/4 FGHT (inlet) x 3/4 MGHT (1 outlet)
GHV-1-BLK-CSK Same As GHV-1-BLK, Clamshelled
GHV-1-BLK-BG Bagged

FEATURES

60 PSI maximum operating pressure
Black nylon construction

GARDEN HOSE WASHERS VINYL



W406V

10373

Part#

OD x ID

W406V
10373

1 x 3/4
1 x 3/4

GHT SHUT-OFF Y-VALVE NYLON



Part#

Connection Size

GHV-2-BLK 3/4 FGHT (inlet) x 3/4 MGHT (2 outlets)
GHV-2-BLK-BG Bagged

FEATURES

60 PSI maximum operating pressure
Black nylon construction

QUICK CONNECT COUPLERS ALUMINUM



Part#

Roller Size

Shaft Size

46814-1-BC
46814-3-BC

4
6

5/8"
5/16"

FEATURES

PTO 1 3/8" Die Cast Aluminum
9 Tooth 540-1000 RPM

TANK ACCESSORIES

LIDS & BASKETS STANDARD FOR SPRAYER TANKS

| TANK LIDS | | |
|---------------|----------|---|
| Part # | Diameter | Style |
| 33-103221 | 5" | Closed |
| 34-140030-CSK | 5" | Closed - With Lanyard |
| G-8140000 | 6" | Closed |
| G-8140002 | 6" | Vented |
| G-8178000 | 6" | Closed - Female |
| G-8178001 | 6" | Vented - Female |
| TL-6B | 6" | Breather - Female |
| TL-6B-BC | 6" | Breather - Female - Barcoded |
| TL-6B-W/GAS | 6" | Breather - Female - With Gasket |
| G-8146000 | 8" | Closed |
| G-8146000-BC | 8" | Closed - Barcoded |
| G-8146002 | 8" | Vented |
| G-8149001 | 8" | Closed -With Ring |
| G-8152000 | 12" | Closed |
| G-8152002 | 12" | Vented |
| G-8155000 | 12" | Vented - With Ring |
| G-8169004 | 12" | Vented - With Hinge |
| G-8158000 | 16" | Closed |
| G-8158002 | 16" | Vented |
| G-8158002-BC | 16" | Vented - Barcoded |
| G-8161000 | 16" | 2 Maze Vents - With Ring |
| G-8170015 | 18" | 180° Opening - Floating Ball Vent Valve |

| LID RINGS | | |
|-----------|----------|-------------|
| Part # | Diameter | With Gasket |
| G-8142000 | 6" | |
| G-8148000 | 8" | |
| G-8148002 | 8" | Yes |
| G-8154000 | 12" | |
| G-8154002 | 12" | Yes |
| G-8160000 | 16" | |
| G-8160002 | 16" | Yes |

| LID GASKETS | | |
|-------------|----------|----------|
| Part # | Diameter | Material |
| TL-6B-GAS | 6" | EPDM |
| G-G00000014 | 16" | EPDM |

| LID STRAINER BASKETS | | |
|----------------------|----------|-------|
| Part # | Diameter | Depth |
| G-8147001 | 5" | 5" |
| TLS-5D | 5" | 1.5" |
| TLS-5D-CSK | 5" | 1.5" |
| G-8147002 | 8" | 9.5" |
| G-8153001 | 12" | 9.5" |
| G-8159000 | 16" | 7" |
| G-8159001 | 16" | 11" |



TLS-5D



TL-6B



G-8158002



G-8160000



G-8159001

POLYPROPYLENE BULK HEAD FITTINGS



| Part# | FNPT | Hole Size | Gasket Only |
|-----------|--------|-----------|---------------|
| BHF12 | 1/2" | 1 3/4" | BHF12/34GAS |
| BHF12-BC | 1/2" | 1 3/4" | ** |
| BHF34 | 3/4" | 1 3/4" | BHF12/34GAS |
| BHF34-BC | 3/4" | 1 3/4" | ** |
| BHF100 | 1" | 2 1/8" | BHF100GAS |
| BHF100-BC | 1" | 2 1/8" | ** |
| BHF114 | 1 1/4" | 2 5/8" | BHF114/112GAS |
| BHF112 | 1 1/2" | 2 5/8" | BHF114/112GAS |
| BHF112-BC | 1 1/2" | 2 5/8" | ** |
| BHF200 | 2" | 3 1/4" | BHF200GAS |
| BHF200-BC | 2" | 3 1/4" | ** |
| BHF300 | 3" | 4 3/8" | BHF300GAS |
| BHF400 | 4" | 5 5/8" | BHF400GAS |

** -BC Suffix Denotes Product is Offered with Barcoding

BOOMLESS NOZZLES



LEFT & RIGHT PATTERN BOOMLESS NOZZLES

Available in left or right spray patterns. Provides a directional spray pattern for overlap coverage when mounted in pairs. Ideal mounting heights between 24"-48". Clamshelled options include a 1/4" x 11/16" female adapter.

| Part# | Pattern | GPM | Orifice Size | Thread Size | Swath |
|----------------|---------|-----|--------------|-------------|-------|
| BN2BP088LSX-CS | Left | 2 | .088 | 1/4" MNPT | 8' |
| BN2BP088LSX | Left | 2 | .088 | 1/4" MNPT | 8' |
| BN2BP088RSX-CS | Right | 2 | .088 | 1/4" MNPT | 8' |
| BN2BP088RSX | Right | 2 | .088 | 1/4" MNPT | 8' |
| BN2BP116LSX-CS | Left | 3 | .116 | 1/4" MNPT | 11' |
| BN2BP116LSX | Left | 3 | .116 | 1/4" MNPT | 11' |
| BN2BP116RSX-CS | Right | 3 | .116 | 1/4" MNPT | 11' |
| BN2BP116RSX | Right | 3 | .116 | 1/4" MNPT | 11' |



FULL PATTERN BOOMLESS NOZZLES

Available in various spray distance values. Deliver a full spray pattern. Designed for wide band spray applications from a single mounted nozzle. Spray distance value at 36" mounted height. Mounting height 24-48". All wide pattern boomless nozzles are two piece construction.

| Part# | Pattern | GPM | Orifice Size | Thread Size | Swath | Construction |
|----------------|---------|-----|--------------|-------------|-------|------------------------------------|
| BN2BP125FWX-CS | Full | 2 | .125 | 1/4" MNPT | 16' | Brass Cap & Poly Body, Clamshelled |
| BN2BP125FWX | Full | 2 | .125 | 1/4" MNPT | 16' | Brass Cap & Poly Body, Bulk |
| BN2BP152FWX-CS | Full | 3 | .152 | 1/4" MNPT | 22' | Brass Cap & Poly Body, Clamshelled |
| BN2BP152FWX | Full | 3 | .152 | 1/4" MNPT | 22' | Brass Cap & Poly Body, Bulk |

BOOMLESS NOZZLES ALL-BRASS



DESCRIPTION

Made with all brass for increased durability. Nozzles can deliver a half or full spray pattern up to 58'. Ideal mounting heights between 24"-48". Clamshelled options include a 1/2" MNPT x 3/8" FNPT reducer bushing.

| Part# | Pattern | GPM | Orifice | Swath |
|-------------|-------------|---------|---------|--------|
| BN6540-01 | Full & Half | 1.7-2.4 | #5 | 44-50' |
| BN6541-01 | Full & Half | 3.7-5.0 | #10 | 50-52' |
| BN6542-01 | Full & Half | 5.1-7.1 | #20 | 54-58' |
| 6540-01-CSK | Full & Half | 1.7-2.4 | #5 | 44-50' |
| 6541-01-CSK | Full & Half | 3.7-5.0 | #10 | 50-52' |
| 6542-01-CSK | Full & Half | 5.1-7.1 | #20 | 54-58' |

RETAIL CLAMSHELL PACKAGING



All nozzles are available packed in retail-ready clamshells with full-color, fold-open informational card inserts.

ACCESSORIES

STRAINERS, NOZZLE BODY KITS & CHEMICAL PROTECTION

NOZZLE STRAINERS

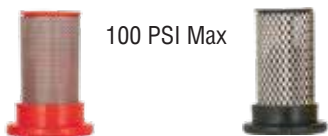

100 PSI Max

| Part# | Description |
|---------------|--|
| NS-50 | 50 Mesh - Red |
| NS-50-CSK | 50 Mesh - Red (4 Pack) |
| NS-50-BC | 50 Mesh w/ Ball Check - Red |
| NS-50-BC-CSK | 50 Mesh w/ Ball Check - Red (4 Pack) |
| NS-100 | 100 Mesh - Black |
| NS-100-CSK | 100 Mesh - Black (4 Pack) |
| NS-100-BC | 100 Mesh w/ Ball Check - Black |
| NS-100-BC-CSK | 100 Mesh w/Ball Check - Black (4 Pack) |

CHEMICAL PROTECTION



| Part# | Description |
|--------------|---------------------------------------|
| CHEM-GLOVE-L | Chemical Resistant Nitrile Gloves, Lg |
| CHEM-GOGGLE | Chemical Resistant Safety Goggles |

POLYPROPYLENE ELBOW NOZZLE BODY KITS



| Part# | Connection Size |
|------------------|-----------------------|
| 34-140025BLK-CSK | 3/8" HB x 11/16" MNPT |
| 34-140043BLK-CSK | 1/2" HB x 11/16" MNPT |

POLYPROPYLENE TEE NOZZLE BODY KITS



| Part# | Connection Size |
|------------------|-----------------------|
| 34-140026BLK-CSK | 3/8" HB x 11/16" MNPT |
| 34-140047BLK-CSK | 1/2" HB x 11/16" MNPT |

POLYPROPYLENE CROSS NOZZLE BODY KITS



| Part# | Connection Size |
|------------------|-----------------------|
| 34-140027BLK-CSK | 3/8" HB x 11/16" MNPT |
| 34-140044BLK-CSK | 1/2" HB x 11/16" MNPT |

NYLON ELBOW NOZZLE BODY KITS



| Part# | Connection Size |
|---------------|-----------------------|
| 34-140025-CSK | 3/8" HB x 11/16" MNPT |
| 34-140043-CSK | 1/2" HB x 11/16" MNPT |

NYLON TEE NOZZLE BODY KITS



| Part# | Connection Size |
|---------------|-----------------------|
| 34-140026-CSK | 3/8" HB x 11/16" MNPT |
| 34-140047-CSK | 1/2" HB x 11/16" MNPT |

NYLON CROSS NOZZLE BODY KITS



| Part# | Connection Size |
|---------------|-----------------------|
| 34-140027-CSK | 3/8" HB x 11/16" MNPT |
| 34-140044-CSK | 1/2" HB x 11/16" MNPT |

SPRAY NOZZLES

& COVERAGE CHARTS



SPRAY NOZZLE CHARTS

RETAIL PACKAGING

Available in retail-ready clamshelled **4-packs** with fold-open informational card inserts.



ALSO AVAILABLE IN BULK.

FLAT FAN NOZZLES

80°/110°

DESIGNED FOR GENERAL SPRAYING

Economical tip for general spraying. Medium drop size with medium drift hazard. Best performance between 30-60 PSI. 20" & 28" suggested spray height.

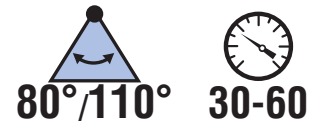

| 80° Part# | Color |
|----------------|--------|
| 90.080.002-CSK | Yellow |
| 90.080.003-CSK | Blue |
| 90.080.004-CSK | Red |
| 90.080.005-CSK | Brown |
| 90.080.006-CSK | Gray |
| 90.080.008-CSK | White |
| 110° Part# | Color |
| 90.110.002-CSK | Yellow |
| 90.110.003-CSK | Blue |
| 90.110.004-CSK | Red |

| Part# | PSI | Capacity Per Nozzle | | Gallons/Acre | | | | | | | |
|----------------------------------|-----|---------------------|--------|--------------|------|------|------|------|------|-------|-------|
| | | GPM | Oz/Min | 4MPH | 5MPH | 6MPH | 7MPH | 8MPH | 9MPH | 10MPH | 12MPH |
| 90.080.002-CSK 90.110.002-CSK | 30 | 0.17 | 22.0 | 12.6 | 10.1 | 8.4 | 7.2 | 6.3 | 5.6 | 5.0 | 4.2 |
| | 40 | 0.20 | 26.0 | 14.9 | 11.9 | 9.9 | 8.5 | 7.4 | 6.6 | 5.9 | 5.0 |
| | 50 | 0.22 | 28.0 | 16.3 | 13.1 | 10.9 | 9.3 | 8.2 | 7.3 | 6.5 | 5.4 |
| | 60 | 0.24 | 31.0 | 17.8 | 14.3 | 11.9 | 10.2 | 8.9 | 7.9 | 7.1 | 5.9 |
| | 75 | 0.27 | 34.8 | 20.0 | 16.1 | 13.4 | 11.5 | 10.0 | 8.9 | 8.0 | 6.6 |
| 90.080.003-CSK 90.110.003-CSK | 30 | 0.26 | 33.0 | 19.3 | 15.4 | 12.9 | 11.0 | 9.7 | 8.6 | 7.7 | 6.4 |
| | 40 | 0.30 | 38.0 | 22.0 | 17.8 | 14.9 | 12.7 | 11.1 | 9.9 | 8.9 | 7.4 |
| | 50 | 0.34 | 44.0 | 25.0 | 20.0 | 16.8 | 14.4 | 12.6 | 11.2 | 10.1 | 8.4 |
| | 60 | 0.37 | 47.0 | 27.0 | 22.0 | 18.3 | 15.7 | 13.7 | 12.2 | 11.0 | 9.2 |
| | 75 | 0.42 | 52.9 | 30.4 | 24.8 | 20.6 | 17.7 | 15.4 | 13.7 | 12.4 | 10.4 |
| 90.080.004-CSK 90.110.004-CSK | 30 | 0.35 | 45.0 | 26.0 | 21.0 | 17.3 | 14.9 | 13.0 | 11.6 | 10.4 | 8.7 |
| | 40 | 0.40 | 51.0 | 30.0 | 24.0 | 19.8 | 17.0 | 14.9 | 13.2 | 11.9 | 9.9 |
| | 50 | 0.45 | 58.0 | 33.0 | 27.0 | 22.0 | 19.1 | 16.7 | 14.9 | 13.4 | 11.1 |
| | 60 | 0.49 | 63.0 | 36.0 | 29.0 | 24.0 | 21.0 | 18.2 | 16.2 | 14.6 | 12.1 |
| | 75 | 0.55 | 70.7 | 40.4 | 32.6 | 27.0 | 23.6 | 20.4 | 18.2 | 16.4 | 13.6 |
| 90.080.005-CSK | 30 | 0.43 | 55.0 | 32.0 | 26.0 | 21.0 | 18.2 | 16.0 | 14.2 | 12.8 | 10.6 |
| | 40 | 0.50 | 64.0 | 37.0 | 30.0 | 25.0 | 21.0 | 18.6 | 16.5 | 14.9 | 12.4 |
| | 50 | 0.56 | 72.0 | 42.0 | 33.0 | 28.0 | 24.0 | 21.0 | 18.5 | 16.6 | 13.9 |
| | 60 | 0.61 | 78.0 | 45.0 | 36.0 | 30.0 | 26.0 | 23.0 | 20.0 | 18.1 | 15.1 |
| | 75 | 0.67 | 86.0 | 49.6 | 39.7 | 33.1 | 28.7 | 25.4 | 22.1 | 20.0 | 16.7 |
| 90.080.006-CSK | 30 | 0.43 | 55.0 | 32.0 | 26.0 | 21.0 | 18.2 | 16.0 | 14.2 | 12.8 | 10.6 |
| | 40 | 0.50 | 64.0 | 37.0 | 30.0 | 25.0 | 21.0 | 18.6 | 16.5 | 14.9 | 12.4 |
| | 50 | 0.56 | 72.0 | 42.0 | 33.0 | 28.0 | 24.0 | 21.0 | 18.5 | 16.6 | 13.9 |
| | 60 | 0.61 | 78.0 | 45.0 | 36.0 | 30.0 | 26.0 | 23.0 | 20.0 | 18.1 | 15.1 |
| | 75 | 0.67 | 86.0 | 49.6 | 39.7 | 33.1 | 28.7 | 25.4 | 22.1 | 20.0 | 16.7 |
| 90.080.008-CSK | 30 | 0.69 | 88.0 | 51.0 | 41.0 | 34.0 | 29.0 | 26.0 | 23.0 | 20.0 | 17.1 |
| | 40 | 0.80 | 102.0 | 59.0 | 48.0 | 40.0 | 34.0 | 30.0 | 26.0 | 24.0 | 19.8 |
| | 50 | 0.89 | 114.0 | 66.0 | 53.0 | 44.0 | 38.0 | 33.0 | 29.0 | 26.0 | 22.0 |
| | 60 | 0.98 | 125.0 | 73.0 | 58.0 | 49.0 | 42.0 | 36.0 | 32.0 | 29.0 | 24.0 |
| | 75 | 1.09 | 140.0 | 81.8 | 65.0 | 54.9 | 47.0 | 40.3 | 35.8 | 32.5 | 26.9 |

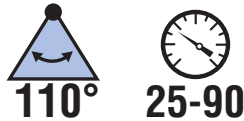

LARGER DROPLETS TO CUT DRIFT

Delivers larger droplets and greatly reduces drift compared to standard. Medium drop size with low drift hazard. Best performance between 25-90 PSI. 20" suggested spray height.

AIR INDUCTION NOZZLES 110°



| 110° Air Induction Nozzles | PSI | Capacity Per Nozzle | | Gallons/Acre 20" Spacing | | | | | | |
|----------------------------|-----|---------------------|--------|-----------------------------|------|------|------|-------|-------|-------|
| | | GPM | Oz/Min | 4MPH | 5MPH | 6MPH | 8MPH | 10MPH | 12MPH | 15MPH |
| G-8259492-CSK | 30 | 0.17 | 22 | 12.6 | 10.1 | 8.4 | 6.3 | 5 | 4.2 | 3.4 |
| | 40 | 0.2 | 26 | 14.9 | 11.9 | 9.9 | 7.4 | 5.9 | 5 | 4 |
| | 50 | 0.22 | 28 | 16.3 | 13.1 | 10.9 | 8.2 | 6.5 | 5.4 | 4.4 |
| | 60 | 0.24 | 31 | 17.8 | 14.3 | 11.9 | 8.9 | 7.1 | 5.9 | 4.7 |
| | 75 | 0.27 | 35 | 20 | 16 | 13.4 | 10 | 8 | 6.7 | 5.3 |
| G-8259493-CSK | 90 | 0.3 | 38 | 22 | 17.8 | 14.9 | 11.1 | 8.9 | 7.4 | 5.9 |
| | 30 | 0.22 | 28 | 16.3 | 13.1 | 10.9 | 8.2 | 6.5 | 5.4 | 4.4 |
| | 40 | 0.25 | 32 | 18.6 | 14.9 | 12.4 | 9.3 | 7.4 | 6.2 | 5 |
| | 50 | 0.28 | 36 | 21 | 16.6 | 13.9 | 10.4 | 8.3 | 6.9 | 5.5 |
| | 60 | 0.31 | 40 | 23 | 18.4 | 15.3 | 11.5 | 9.2 | 7.7 | 6.1 |
| G-8259494-CSK | 75 | 0.34 | 44 | 25 | 20 | 16.8 | 12.6 | 10.1 | 8.4 | 6.7 |
| | 90 | 0.38 | 49 | 28 | 23 | 18.8 | 14.1 | 11.3 | 9.4 | 7.5 |
| | 30 | 0.26 | 33 | 19.3 | 15.4 | 12.9 | 9.7 | 7.7 | 6.4 | 5.1 |
| | 40 | 0.3 | 38 | 22 | 17.8 | 14.9 | 11.1 | 8.9 | 7.4 | 5.9 |
| | 50 | 0.34 | 44 | 25 | 20 | 16.8 | 12.6 | 10.1 | 8.4 | 6.7 |
| G-8259495-CSK | 60 | 0.37 | 47 | 27 | 22 | 18.3 | 13.7 | 11 | 9.2 | 7.3 |
| | 75 | 0.41 | 52 | 30 | 24 | 20 | 15.2 | 12.2 | 10.1 | 8.1 |
| | 90 | 0.45 | 58 | 33 | 27 | 22 | 16.7 | 13.4 | 11.1 | 8.9 |
| | 30 | 0.35 | 45 | 26 | 21 | 17.3 | 13 | 10.4 | 8.7 | 6.9 |
| | 40 | 0.4 | 51 | 30 | 24 | 19.8 | 14.9 | 11.9 | 9.9 | 7.9 |
| G-8259496-CSK | 50 | 0.45 | 58 | 33 | 27 | 22 | 16.7 | 13.4 | 11.1 | 8.9 |
| | 60 | 0.49 | 63 | 36 | 29 | 24 | 18.2 | 14.6 | 12.1 | 9.7 |
| | 75 | 0.55 | 70 | 41 | 33 | 27 | 20 | 16.3 | 13.6 | 10.9 |
| | 90 | 0.6 | 77 | 45 | 36 | 30 | 22 | 17.8 | 14.9 | 11.9 |
| | 30 | 0.43 | 55 | 32 | 26 | 21 | 16 | 12.8 | 10.6 | 8.5 |
| G-8259497-CSK | 40 | 0.5 | 64 | 37 | 30 | 25 | 18.6 | 14.9 | 12.4 | 9.9 |
| | 50 | 0.56 | 72 | 42 | 33 | 28 | 21 | 16.6 | 13.9 | 11.1 |
| | 60 | 0.61 | 78 | 45 | 36 | 30 | 23 | 18.1 | 15.1 | 12.1 |
| | 75 | 0.68 | 87 | 50 | 40 | 34 | 25 | 20 | 16.8 | 13.5 |
| | 90 | 0.75 | 96 | 56 | 45 | 37 | 28 | 22 | 18.6 | 14.9 |
| G-8259557-CSK | 30 | 0.52 | 67 | 39 | 31 | 26 | 19.3 | 15.4 | 12.9 | 10.3 |
| | 40 | 0.6 | 77 | 45 | 36 | 30 | 22 | 17.8 | 14.9 | 11.9 |
| | 50 | 0.67 | 86 | 50 | 40 | 33 | 25 | 19.9 | 16.6 | 13.3 |
| | 60 | 0.73 | 93 | 54 | 43 | 36 | 27 | 22 | 18.1 | 14.5 |
| | 75 | 0.82 | 105 | 61 | 49 | 41 | 30 | 24 | 20 | 16.2 |
| 90 | 0.9 | 115 | 67 | 53 | 45 | 33 | 27 | 22 | 17.8 | |

| Part# | Color |
|---------------|--------|
| G-8259492-CSK | Yellow |
| G-8259493-CSK | Purple |
| G-8259494-CSK | Blue |
| G-8259495-CSK | Red |
| G-8259557-CSK | Gray |

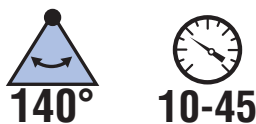

LARGER DROPLETS, CLOG RESISTANT

Deflecting design creates wide angle spray. Larger orifice for clog resistance. Best performance between 10-45 PSI. Medium drop size with low drift hazard. 20" suggested spray height.

DEFLECTOR NOZZLES 140°



| Part# | PSI | Capacity Per Nozzle | | Gallons/Acre | | | | | | | |
|------------|-----|---------------------|--------|--------------|------|------|------|-------------|------|------|------|
| | | GPM | Oz/Min | 30" Spacing | | | | 40" Spacing | | | |
| | | | | 5MPH | 6MPH | 7MPH | 8MPH | 5MPH | 6MPH | 7MPH | 8MPH |
| DF2.0-CSK | 10 | 0.20 | 26 | 7.9 | 6.6 | 5.7 | 5.0 | 5.9 | 5.0 | 4.2 | 3.7 |
| | 20 | 0.28 | 36 | 11.1 | 9.2 | 7.9 | 6.9 | 8.3 | 6.9 | 5.9 | 5.2 |
| | 30 | 0.35 | 45 | 13.9 | 11.6 | 9.9 | 8.7 | 10.4 | 8.7 | 7.4 | 6.5 |
| | 40 | 0.40 | 51 | 15.8 | 13.2 | 11.3 | 9.9 | 11.9 | 9.9 | 8.5 | 7.4 |
| DF2.5-CSK | 10 | 0.25 | 32 | 9.9 | 8.3 | 7.1 | 6.2 | 7.5 | 6.2 | 5.3 | 4.7 |
| | 20 | 0.36 | 46 | 14.0 | 11.5 | 10.0 | 8.8 | 10.5 | 8.8 | 7.6 | 6.6 |
| | 30 | 0.44 | 56 | 17.0 | 14.5 | 12.5 | 11.0 | 13.0 | 11.0 | 9.3 | 8.1 |
| | 40 | 0.50 | 64 | 20.0 | 16.5 | 14.0 | 12.5 | 15.0 | 12.5 | 10.5 | 9.3 |
| DF3.0-CSK | 10 | 0.30 | 39 | 11.9 | 9.9 | 8.6 | 7.5 | 8.9 | 7.5 | 6.3 | 5.6 |
| | 20 | 0.42 | 54 | 16.7 | 13.8 | 11.9 | 10.4 | 12.5 | 10.4 | 8.9 | 7.8 |
| | 30 | 0.53 | 68 | 20.9 | 17.4 | 14.9 | 13.1 | 15.6 | 13.1 | 11.1 | 9.8 |
| | 40 | 0.60 | 77 | 23.7 | 19.8 | 17.0 | 14.9 | 17.9 | 14.9 | 12.8 | 11.1 |
| DF4.0-CSK | 10 | 0.40 | 52 | 15.8 | 13.2 | 11.4 | 10.0 | 11.8 | 10.0 | 8.4 | 7.4 |
| | 20 | 0.56 | 72 | 22.2 | 18.4 | 15.8 | 13.8 | 16.6 | 13.8 | 11.8 | 10.4 |
| | 30 | 0.70 | 90 | 27.8 | 23.2 | 19.8 | 17.4 | 20.8 | 17.4 | 14.8 | 13.0 |
| | 40 | 0.80 | 102 | 32 | 26.4 | 22.6 | 19.8 | 23.8 | 19.8 | 17.0 | 14.8 |
| DF5.0-CSK | 10 | 0.50 | 64 | 20 | 16.5 | 14.1 | 12.4 | 14.9 | 12.4 | 10.6 | 9.3 |
| | 20 | 0.71 | 91 | 28 | 23 | 20 | 17.6 | 21 | 17.6 | 15.1 | 13.2 |
| | 30 | 0.87 | 111 | 34 | 29 | 25 | 22 | 26 | 22 | 18.5 | 16.1 |
| | 40 | 1.00 | 128 | 40 | 33 | 28 | 25 | 30 | 25 | 21.0 | 18.6 |
| DF7.5-CSK | 10 | 0.75 | 96 | 30 | 25 | 21 | 19 | 22 | 19 | 15.9 | 14.0 |
| | 20 | 1.07 | 137 | 42 | 35 | 30 | 26 | 32 | 26 | 23 | 19.8 |
| | 30 | 1.31 | 167 | 51 | 44 | 38 | 33 | 39 | 33 | 28 | 24 |
| | 40 | 1.50 | 192 | 60 | 50 | 42 | 38 | 45 | 38 | 32 | 28 |
| DF10.0-CSK | 10 | 1.00 | 128 | 40 | 33 | 28 | 25 | 30 | 25 | 21 | 19 |
| | 20 | 1.42 | 182 | 56 | 46 | 40 | 35 | 42 | 35 | 30 | 26 |
| | 30 | 1.74 | 222 | 68 | 58 | 50 | 44 | 52 | 44 | 37 | 32 |
| | 40 | 2.00 | 256 | 80 | 66 | 56 | 50 | 60 | 50 | 42 | 37 |

| Part# | Color |
|------------|-------|
| DF2.0-CSK | Red |
| DF2.5-CSK | Brown |
| DF3.0-CSK | Gray |
| DF4.0-CSK | White |
| DF5.0-CSK | Blue |
| DF7.5-CSK | Green |
| DF10.0-CSK | Black |



ADAPTERS & PLUMBING

INLET STRAINER



| Part# | Connection Size | Packaging |
|---------------|-----------------|-------------|
| 33-103121 | 3/8" HB | Bulk |
| 33-103121-CSK | 3/8" HB | Clamshelled |
| 33-103122 | 1/2" HB | Bulk |
| 33-103122-BC | 1/2" HB | Barcoded |

MANIFOLD



| Part# | Description |
|---------------|-------------------------------|
| 34-140068-CSK | Manifold with 1/4" Gauge Port |

QUICK CONNECT FITTINGS 4-PIECE KIT



| Part# | Description |
|------------|--|
| EF-QC-KIT1 | Add Quick Connect Ports to Most Manufacturer's 12 Volt Diaphragm Pumps |

PRESSURE VARIABLE REGULATOR



| Part# | Description |
|---------------|--|
| 34-140118 | Sprayer Regulator w/QC Adapter - Bulk |
| 34-140118-CSK | Sprayer Regulator w/QC Adapter - Clamshelled |
| 34-140162 | 200 PSI Sprayer regulator w/QC Adapter |

ON/OFF VALVE UNIVERSAL



| Part# | Connection Size |
|----------------|-----------------------------------|
| 34-140141 | Male QC x Female QC - Bulk |
| 34-140141-CSK* | Male QC x Female QC - Clamshelled |

*Includes QC x 3/4" MGHT & QC x 3/8" Hose Barb Adapters

QUICK CONNECT FITTINGS



| Part# | Type | Connection Size |
|---------------|-----------|-----------------------|
| EF-QC-M12 | Adapter | 1/2" MNPT x QC |
| EF-QC-E34 | Adapter | 3/4" MGHT x QC |
| EF-QC-FQA/M38 | Adapter | 3/8" MNPT x Female QC |
| EF-QC-A38 | Hose Barb | 3/8" HB x QC |
| EF-QC-A12 | Hose Barb | 1/2" HBx QC |
| EF-QC-A34 | Hose Barb | 3/4" HB x QC |
| EF-QC-EL38 | Elbow | 3/8" HB x QC |
| EF-QC-EL12 | Elbow | 1/2" HB x QC |
| EF-QC-50EL12 | 50° Elbow | 1/2" HB x QC |
| EF-QC-EL34 | Elbow | 3/4" x QC |

** Add -CSK suffix for clamshell retail packaging.

SPRAYER

ACCESSORIES

DRAIN CAP KIT



| Part# | Includes |
|-----------|--|
| 34-140007 | Drain Plug Cap, Drain Plug Cap Tether, Drain Plug Gasket |

SPOT SPRAYER REPLACEMENT KIT



| Part# | Includes |
|---------------|---|
| 34-140029-CSK | Replace common wear items with this kit. Includes: (2) Spray Gun Mounting Clips, (1) Drain Plug Cap with Tether, (1) 3/8" Hose Barb x 3/8" MPT for Connecting Hose to Pump |

INLINE STRAINER CLEAR BOWL



| Part# | Connection Size | Packaging |
|---------------|------------------------|-------------|
| 34-140164 | 1/2" HB x Quick Attach | Bulk |
| 34-140164-CSK | 1/2" HB x Quick Attach | Clamshelled |

HOOK & LOOP HOSE STRAP



| Part # | Features |
|----------------|---|
| HOSE-STRAP-CSK | Organizes spray gun hose. Includes self-tapping screw. Installs on most manufacturer's tanks. |

APPLICATIONS

- Industrial
- Agriculture
- Automotive
- Lawn Care
- Household



MEASURING PITCHERS POLYPROPYLENE

Chemical resistant polypropylene measuring pitchers featuring an ergonomic handle and black, debossed graduations.

| Part# | Size |
|--------|----------------|
| MP-08 | 8oz / 250ml |
| MP-16 | 16oz / 500ml |
| MP-32 | 32oz / 1000ml |
| MP-64 | 64oz / 2000ml |
| MP-128 | 128oz / 4000ml |



HOSE CLAMPS

WORM GEAR HOSE CLAMPS STEEL



| Series# | Description |
|----------|--|
| 300, 600 | Stainless steel band & housing, plated screw |
| 350, 620 | Stainless steel band, housing & screw |

| 5/16" Band | | |
|-------------|--------|-------------|
| Part# | Size | Packaging |
| 300-004-CSK | 1/4" | Clamshelled |
| 350-004 | 1/4" | |
| 350-005 | 9/16" | |
| 300-006 | 3/8" | |
| 300-006-CSK | 3/8" | Clamshelled |
| 350-006 | 3/8" | |
| 350-008 | 1/2" | |
| 350-010 | 5/8" | |
| 350-012 | 3/4" | |
| 350-016 | 1" | |
| 1/2" Band | | |
| 620-006 | 3/8" | |
| 620-008 | 1/2" | |
| 620-010 | 5/8" | |
| 600-012-CSK | 3/4" | Clamshelled |
| 620-012 | 3/4" | |
| 620-016 | 1" | |
| 600-020-CSK | 1 1/4" | Clamshelled |
| 620-020 | 1 1/4" | |

| 1/2" Band (continued) | | |
|-----------------------|--------|-------------|
| Part# | Size | Packaging |
| 620-024 | 1 1/2" | |
| 620-028 | 1 3/4" | |
| 620-032 | 2" | |
| 620-036 | 2 1/4" | |
| 620-040 | 2 1/2" | |
| 620-044 | 2 3/4" | |
| 620-048 | 3" | |
| 620-052 | 3 1/4" | |
| 620-056 | 3 1/2" | |
| 620-060 | 3 3/4" | |
| 600-064 | 4" | |
| 600-064-CSK | 4" | Clamshelled |
| 620-064 | 4" | |
| 620-072 | 4 1/2" | |
| 620-080 | 5" | |
| 620-088 | 5 1/2" | |
| 620-096 | 6" | |
| 620-104 | 6 1/2" | |
| 620-128 | 8" | |

SNAPPER HOSE CLAMPS PLASTIC



Features
Double Tooth Locking System



* -CSK are Clamshelled 6 Packs

| Part# | Fits | Min Diameter | Max Diameter |
|------------|-----------|--------------|--------------|
| SHC-A | | 0.228" | 0.356" |
| SHC-AA | | 0.256" | 0.319" |
| SHC-B | | 0.311" | 0.378" |
| SHC-BB | | 0.351" | 0.394" |
| SHC-C | | 0.402" | 0.485" |
| SHC-D | 1/4" Hose | 0.449" | 0.511" |
| SHC-D-CSK | 1/4" Hose | 0.449" | 0.511" |
| SHC-E | | 0.516" | 0.619" |
| SHC-F | 3/8" Hose | 0.616" | 0.707" |
| SHC-F-CSK* | 3/8" Hose | 0.616" | 0.707" |
| SHC-G | | 0.666" | 0.784" |
| SHC-H | | 0.702" | 0.801" |
| SHC-J | 1/2" Hose | 0.779" | 0.899" |
| SHC-J-CSK* | 1/2" Hose | 0.779" | 0.899" |
| SHC-K | | 0.900" | 1.000" |
| SHC-L | | 0.985" | 1.135" |
| SHC-M | 3/4" Hose | 1.044" | 1.198" |
| SHC-M-CSK* | 3/4" Hose | 1.044" | 1.198" |
| SHC-N | | 1.123" | 1.296" |
| SHC-P | | 1.261" | 1.403" |
| SHC-Q | | 1.351" | 1.525" |
| SHC-R | | 1.338" | 1.566" |
| SHC-V | | 1.730" | 2.010" |

BOOM ACCESSORIES

NOZZLE BODY BOOM CLAMPS SQUARE



| Part# | Size | Type | Packaging |
|---------------|------|------------|-------------|
| BCS-100 | 1" | Standard | Bulk |
| BCS-100-CSK | 1" | Standard | Clamshelled |
| BCS-114-CSK | 1¼" | Standard | Clamshelled |
| G-8235037 | ¾" | Vari-Space | Bulk |
| G-8235037-CSK | ¾" | Vari-Space | Clamshelled |
| G-8235039 | 1" | Vari-Space | Bulk |
| G-8235039-CSK | 1" | Vari-Space | Clamshelled |
| G-8235041 | 1¼" | Vari-Space | Bulk |
| G-8235041-CSK | 1¼" | Vari-Space | Clamshelled |
| G-8235043 | 1½" | Vari-Space | Bulk |
| G-8235043-CSK | 1½" | Vari-Space | Clamshelled |

NOZZLE BODY BOOM CLAMPS ROUND



| Part# | Size | Type | Packaging |
|---------------|------|------------|-------------|
| BCR-34 | ¾" | Standard | Bulk |
| BCR-34-CSK | ¾" | Standard | Clamshelled |
| BCR-100 | 1" | Standard | Bulk |
| BCR-100-CSK | 1" | Standard | Clamshelled |
| G-8235036 | ¾" | Vari-Space | Bulk |
| G-8235036-CSK | ¾" | Vari-Space | Clamshelled |
| G-8235038 | 1" | Vari-Space | Bulk |
| G-8235038-CSK | 1" | Vari-Space | Clamshelled |

DIAPHRAGM CHECK NOZZLE BODIES ELBOW & TEE



| Part# (Bulk) | Part# (Clamshell) | Type | Connection Size |
|--------------|-------------------|-------|-----------------|
| 4240N-B1215 | G-8235019-CSK | Elbow | 3/8" HB x QA |
| G-8235021 | G-8235021-CSK | Elbow | 1/2" HB x QA |
| G-8235023 | G-8235023-CSK | Elbow | 3/4" HB x QA |
| G-8235025 | G-8235025-CSK | Tee | 3/8" HB x QA |
| G-8235027 | G-8235027-CSK | Tee | 1/2" HB x QA |
| G-8235029 | G-8235029-CSK | Tee | 3/4" HB x QA |

NO CHECK NOZZLE BODIES ELBOW, TEE & CROSS



| Part# (Bulk) | Part# (Clamshell) | Type | Connection Size |
|--------------|-------------------|-------|-----------------|
| 31-400008 | G-8231001-CSK | Elbow | 3/8" HB x QA |
| G-8231003 | G-8231003-CSK | Elbow | 1/2" HB x QA |
| G-8231005 | G-8231005-CSK | Elbow | 3/4" HB x QA |
| 31-400009 | G-8231007-CSK | Tee | 3/8" HB x QA |
| G-8231009 | G-8231009-CSK | Tee | 1/2" HB x QA |
| G-8231011 | G-8231011-CSK | Tee | 3/4" HB x QA |
| G-8231013 | G-8231013-CSK | Cross | 3/8" HB x QA |

NOZZLE ACCESSORIES

CHECK VALVE NOZZLE HOLDERS



| Part# | Description |
|---------------|--------------------------|
| G-8234037 | 1/4" NPT F Nozzle Holder |
| G-8234040-8 | 1/4" FNPT x 1/4" MNPT |
| G-8234043-CSK | Check Valve |

NOZZLE SWIVEL



| Part# | Connection Size |
|---------------|-----------------|
| G-8247015-CSK | 1/4" FNPT |

NOZZLE CAPS QUICK ATTACH



| Part# | Color | Nozzle Style |
|---------------|--------|--------------|
| 34-140042-CSK | Yellow | Flat Fan |
| G-8253000-CSK | Red | Flat Fan |
| G-8253051-CSK | Black | Deflector |

NOZZLE CAP SHUT-OFF



| Part# | Features |
|---------------|---|
| G-8253040-CSK | Replacement for Master MFG spray boom SSBK-PNB. |

FPTxQA ADAPTER



| Part# | Connection Size |
|---------------|-----------------|
| G-8230021-CSK | 1/4" FNPT |

GASKET & DIAPHRAGM EPDM



| Part# | Type | Qty |
|-----------------|-----------|-----|
| G-M00100000-CSK | Diaphragm | 12 |
| G-00002020-CSK | Gasket | 12 |

NOZZLE CAPS FNPT



| Part# | Connection Size | Color |
|---------------|-----------------|-------|
| G-8253048-CSK | 1/4" FNPT | Black |

NOZZLE BODY QUICK CLIP NYLON



| Part# | FEATURES |
|---------------|--|
| 31-400010-CSK | Replacement for Master MFG spray booms Comes in four pack |

NYLON DROP HOSE



| Part# | Length |
|---------------|--------|
| G-8251000-CSK | 15" |
| G-8251002-CSK | 24" |

BULK TANKS

15 GALLON



| Part# | Color | Features |
|-----------------------------------|--------|----------------|
| T-015-WWNA-XL | White | Standard |
| T-015-YYNA-XL | Yellow | Standard |
| Dimensions: 34" x 15.69" x 12.75" | | Pallet Qty: 18 |

25 GALLON



| Part# | Color | Features |
|--------------------------------------|--------|----------------|
| T-025-WWNA-XL | White | Standard |
| T-025-YYNA-XL | Yellow | Standard |
| Dimensions: 35.50" x 17.58" x 16.25" | | Pallet Qty: 15 |

40 GALLON



| Part# | Color | Sump |
|-------------------------------|--------|---------------|
| T-040-WWNA-XL | White | No |
| T-040-WWSA-XL | White | Yes |
| T-040-YYNA-XL | Yellow | No |
| T-040-YYSA-XL | Yellow | Yes |
| Dimensions: 36" x 24" x 18.5" | | Pallet Qty: 6 |

60 GALLON



| Part# | Color | Sump |
|-------------------------------|--------|---------------|
| T-060-WWNA-XL | White | No |
| T-060-WWSA-XL | White | Yes |
| T-060-YYNA-XL | Yellow | No |
| T-060-YYSA-XL | Yellow | Yes |
| Dimensions: 36" x 24" x 24.5" | | Pallet Qty: 6 |

- 15, 25, 40, and 60 Gallon Capacities
- Chemical Resistant Polyethylene Construction
- Mold-in Drain Port with Tethered Cap
- Translucent Tank Walls for Viewing Fluid Levels
- Glyphosate Compatible
- Standard Pump & Component Mount Inserts
- Tethered, Screw-on Fill Lid
- UV Stabilized Colors
- Boxed and Barcoded

Other color options available. Minimum Order Quantities required.

BULK TANK FEATURES

WIRE HARNESSSES & SPRAY GUN REPAIR KITS

WIRE HARNESS WITH CLAMPS



| Part# | Length | Gauge | Amps |
|---------------|--------|-------|------|
| 33-103233 | 10' | 16 | 7 |
| 33-103233-CSK | 10' | 16 | 7 |

WIRE HARNESS WITH DC PLUG



| Part# | Length | Gauge | Amps |
|---------------|--------|-------|------|
| 33-103260 | 8' | 18 | 7 |
| 33-103260-CSK | 8' | 18 | 7 |

HEAVY DUTY WIRE HARNESS WITH CLAMPS



| Part# | Length | Gauge | Amps |
|---------------|--------|-------|------|
| 33-103351 | 8' | 12 | 20 |
| 33-103351-CSK | 8' | 12 | 20 |

12 VOLT WIRELESS REMOTE CONTROL



| Part# | Description |
|---------------|---|
| 33-103343-CSK | Features Enlarged Power Button. Includes Remote Box. 100' Range. 20 Max Amps. |

WIRE HARNESS EXTENSION



| Part# | Length | Gauge | Amps |
|---------------|--------|-------|------|
| WHE-14-72-CSK | 6' | 14 | 20 |

REPLACEMENT SPRAY TIPS



| Part# | Compatible Spray Guns |
|------------------|-----------------------|
| SG-45ASSY-18 | SG-4507F, SG-500T |
| SG-45ASSY-18-CSK | SG-4507F, SG-500T |
| SG-4200TIP-CSK | SG-4200 |

SPRAY GUN MOUNTING KITS



GC-100



GC-2255

| Part# | Description |
|------------|---|
| GC-100-KIT | Includes Two Clips, & Two 10-24 x 1/2" Machine Screws |
| GC-100 | Same as above, bulk. |
| GC-2255 | Clip to Hold 3/8-5/8" Diameter Gun Lances |

-CSK suffix denotes retail-ready clamshell packaging.

SPRAY GUNS

SPRAY GUN REPAIR KIT 1700 SERIES



| Part# | Repair Kit |
|----------------|---------------|
| SG-1700-NZLKIT | Spray Nozzle |
| SG-1700-INTKIT | Gun Internals |
| SG-1700-TRGKIT | Gun Trigger |

SPRAY GUN REPAIR KIT 2200 SERIES



| Part# | Compatible Spray Guns |
|----------------|-----------------------|
| SG-2200KIT-CSK | SG-2200 |

SPOT SPRAY GUN ADJUSTABLE



| Part# |
|---------------|
| SG-4200-18 |
| SG-4200-18-CB |

FEATURES

Ideal for up to 100 PSI & 2.2 GPM #18 orifice
 Trigger lock for continuous use Filter in handle
 30" overall length 3/8" hose barb inlet

Compatible Replacement Parts

| | |
|------------|------------|
| GC-100 | GC-100-KIT |
| SG-4200TIP | GC-2255 |

SPOT SPRAY GUN ADJUSTABLE



| Part# |
|-------------|
| SG-4507F |
| SG-4507F-CB |

FEATURES

Ideal for up to 100 PSI & 2.2 GPM #18 orifice
 Trigger lock for continuous use Filter in handle
 30" overall length 3/8" hose barb inlet

Compatible Replacement Parts

| | |
|--------------|------------|
| GC-100 | GC-100-KIT |
| SG-45ASSY-18 | GC-2255 |

TELESCOPING SPOT SPRAY GUN ADJUSTABLE



| Part# |
|------------|
| SG-500T |
| SG-500T-CB |

FEATURES

Ideal for up to 100 PSI & 2.2 GPM #18 orifice
 Trigger lock for continuous use Filter in handle
 40" overall length 3/8" hose barb inlet

Compatible Replacement Parts

| | |
|--------------|------------|
| GC-100 | GC-100-KIT |
| SG-45ASSY-18 | GC-2255 |

PISTOL SPOT SPRAY GUN ADJUSTABLE



| Part# | Spray Gun Length |
|---------------|------------------|
| SG-5518-09 | 9" |
| SG-5518-09-CB | 9" |
| SG-5518-18 | 18" |
| SG-5518-18-CB | 18" |
| SG-5518-24 | 24" |

FEATURES

Ideal for up to 350 PSI and 7.0GPM #18 orifice size
 3/8" brass hose barb inlet Heavy-duty brass nozzle
 Trigger lock to prevent unwanted spray

-CB suffix denotes retail-ready, feature wrap packaging.

SPRAY

DELUXE ADJUSTABLE SPRAY GUNS PISTOL GRIP



| Part# | Length | Color |
|---------------|--------|-------|
| SG-2218-18 | 18" | Blue |
| SG-2218-18-CB | 18" | Blue |
| SG-2218-18-R | 18" | Red |
| SG-2218-24 | 24" | Red |
| SG-2218-24-CB | 24" | Red |

FEATURES

Ideal for up to 250 PSI and 7.0GPM #18 orifice size
 Trigger lock for continuous use Heavy-duty brass nozzle
 3/8" hose barb inlet

DELUXE ADJUSTABLE SPRAY GUN WANDLESS PISTOL GRIP



Part#

SG-5524-00

FEATURES

Ideal for up to 350 PSI #24 orifice size
 3/8" FNPT inlet Nozzle twists from stream to mist
 Heavy-duty brass nozzle Trigger lock prevents unwanted spray

FLASH SPRAY GUN ADJUSTABLE



| Part# | Length |
|--------------|--------|
| SG-2200 | 16" |
| SG-2200-CSK* | 16" |

FEATURES

Ideal for up to 400 PSI and 5.0 GPM.
 Adjustable lever that provides steady stream or atomized mist.
 No-drip shut-off at end of barrel.
 Trigger lock for continuous use.
 3/8" brass hose barb inlet.
 *Includes interchangeable #2 and #2.5 orifice nozzles and 1/2" hose barb.

SPRAY GUN SWIVEL BRASS



| Part# | Description |
|---------|-------------------------|
| SW-12BS | 1/2" MBSPT x 1/2" FBSPT |

RETAIL PACKAGING FOR SPRAY GUNS INCLUDES:



- Plastic Peghook Hole for Hanging
- Full Color, Two-Sided Feature Wrap



LONG RANGE SPRAY GUN ADJUSTABLE



| Part# | Length |
|---------|--------|
| SG-3200 | 26.5" |

FEATURES

Ideal for up to 800 PSI and 25.0 GPM.
 Adjustable handle that provides steady stream or atomized mist.
 No-drip shut-off at end of barrel.
 Trigger lock for continuous use.
 1/2" brass hose barb inlet.

-CSK suffix denotes retail-ready clamshell packaging.

-CB suffix denotes retail-ready, feature wrap packaging.

GUNS

JETSTREAM

Made with aluminum barrels, Jetstream Spray Guns are designed for more intensive sprayer applications that require higher volumes of liquid.

JETSTREAM PISTOL SPRAY GUN 13" OR 22" BARREL



| Part# | Barrel Length |
|------------|---------------|
| SG-1700-13 | 13" |
| SG-1700-22 | 22" |

FEATURES

Ideal for up to 800 PSI.
Goes from stream to mist during trigger pull.
No-drip shut-off at end of barrel.
Chemical-resistant plastic handle for increased durability.
1/2" FNPT inlet.

JETSTREAM TWIST SPRAY GUN 23" BARREL



| Part# | Barrel Length |
|---------|---------------|
| SG-1005 | 23" |

FEATURES

Ideal for up to 400 PSI.
Goes from stream to mist with a twist of the handle.
No-drip shut-off at end of barrel.
Chemical-resistant plastic handle for increased durability.
3/4" FGHT inlet.

PEST CONTROL SPRAY GUN ADJUSTABLE JET



Part#
SG-PC-025

FEATURES

Durable Teflon Seals
2.5MM Spray Nozzle
Adjustable Mist-Jet

Brass 1/2" FNPT Inlet
Locking spray grip
800 PSI Max

REPLACEMENT NOZZLES



| Part# | Size | Dia. | GPM |
|------------|-------|------|----------|
| SG-PCN-008 | Small | 0.8 | 0.3-0.5 |
| SG-PCN-015 | Med | 1.5 | 0.5-2.0 |
| SG-PCN-025 | Large | 2.5 | 2.0-5.0 |
| SG-PCN-030 | XL | 3.0 | 3.0-7.0 |
| SG-PCN-040 | 2XL | 4.0 | 6.0-11.0 |
| SG-PCN-045 | 3XL | 4.5 | 8.0-13.5 |

BRASS SPRAY TIP ADJUSTABLE



| Part# | Orifice Size |
|----------------|--------------|
| 900.054-8 | #8 |
| 900.054-8-CSK | #8 |
| 900.054-18 | #18 |
| 900.054-18-CSK | #18 |
| 900.054-24 | #24 |

HOSE REELS

75-200 FOOT HOSE REELS MANUAL



| Part# | Hose Capacity |
|--------|---------------|
| HR-75 | 75' |
| HR-100 | 100' |
| HR-200 | 200' |

FEATURES

3/8" ID Spray Hose
Swivel included

Powder coated steel frame
3000 PSI Max.

HOSE REEL SWIVELS



| Part# | Connection Size | PSI |
|-----------|-----------------------|------|
| 33-201018 | 1/2" MNPT x 1/2" FNPT | 725 |
| 33-201078 | 1/2" FNPT x 1/2" FNPT | 725 |
| HRS-6M6F | 3/8" MNPT x 3/8" FNPT | 4000 |
| HRS-8M8F | 1/2" MNPT x 1/2" FNPT | 4000 |
| 33-103831 | 1/2" MNPT x 1/2" FNPT | 5000 |
| 33-201035 | 1/2" FNPT x 1/2" FNPT | 5000 |

12" & 18" ALUMINUM HOSE REELS HEAVY-DUTY MANUAL

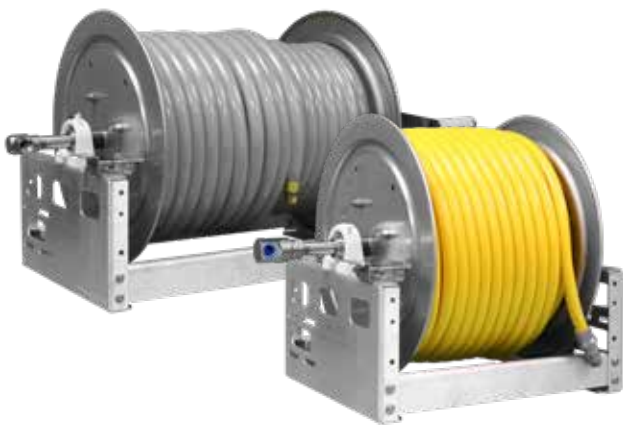

| Part# | Size | Type | PSI |
|------------|------|---------------|------|
| HR-12AF-SW | 12" | Soft Wash | 750 |
| HR-18AF-SW | 18" | Soft Wash | 750 |
| HR-12AF-HP | 12" | High Pressure | 5000 |
| HR-18AF-HP | 18" | High Pressure | 5000 |

FEATURES

3/4" ID Spray Hose
HARDCORE Technology
1/2" NPT threads

Aircraft aluminum frame
Bolt-on construction
Lightweight & durable

12" & 18" ALUMINUM HOSE REELS HEAVY-DUTY ELECTRIC



| Part# | Size | Type | PSI |
|--------------|------|---------------|------|
| HR-12AF-E-SW | 12" | Soft Wash | 750 |
| HR-18AF-E-SW | 18" | Soft Wash | 750 |
| HR-12AF-E-HP | 12" | High Pressure | 5000 |
| HR-18AF-E-HP | 18" | High Pressure | 5000 |

FEATURES

3/4" ID Spray Hose
HARDCORE Technology
1/2" NPT threads

Aircraft aluminum frame
Heavy-duty electric motor
Includes chain guard

SPRAYERS

HANDHELD



SPRAYER FEATURES

- Lightweight and Easy to Use
- Single Conical Spray Tip
- Pressure Relief Valve
- Handle-Action Piston Pump
- Large Mouth for Easy Filling
- Ergonomic Handle

1.2 & 2.0 LITER SPRAYERS HANDHELD



| Part# | Capacity |
|----------|------------------------|
| 90700012 | 1.2 Liter (.32 Gallon) |
| 90700002 | 2.0 Liter (.51 Gallon) |

ALUMINUM STACKING KITS HEAVY-DUTY

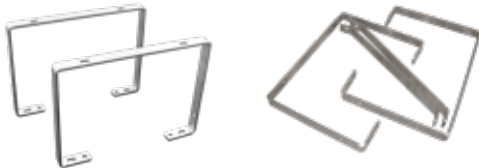

| Part# | Compatible Valley Hose Reels |
|--------------|------------------------------|
| HR-AFST-KIT | Manual |
| HR-AFEST-KIT | Electric |

ALUMINUM HOSE GUIDES HEAVY-DUTY



| Part# | Size | Compatible Valley Hose Reels |
|----------|------|------------------------------|
| HG-12-AL | 12" | Manual & Electric |
| HG-18-AL | 18" | Manual & Electric |

6.5 & 8.0 LITER SPRAYERS HANDHELD



| Part# | Capacity |
|----------|--------------------------|
| 90700065 | 6.5 Liter (1.72 Gallons) |
| 90700008 | 8.0 Liter (2.11 Gallons) |

BACKPACK

4 GALLON BACKPACK SPRAYER HAND PUMPED



FEATURES

- Fan, Conical, 4-Hole Adjustable & Dual Conical Spray Tips Included
- Ergonomically Designed Tank.
- Wide-Mouthed Tank Lid Opening for Less Spillage
- Easily Convert from Left to Right Hand Operation
- Lever Action Piston Pump Offers 15-90 PSI
- Built-In Carry Handle Lid for Easy Transport
- Lance Clips to the Tank for Convenient Storage
- Built-In Strainer & Screen to Prevent Clogging
- Quick Fitting Shoulder Harness
- Quality Viton Seals
- Complete Spare Parts Kit

BPS-405



INCLUDED SPRAY TIPS

FLAT FAN



CONICAL



4-HOLE ADJUSTABLE



DUAL CONICAL



INCLUDED REPAIR KIT BPS-405-9



| Part# | Description |
|-----------|--|
| BPS-405-9 | Complete seal and parts kit included with sprayer. |

SPRAYERS



FEATURES

- No Pumping & No Wires Required
- 14.4 Volt Lithium-Ion Rechargeable Battery
- Internal Battery Compartment
- 1.0 GPM Everflo Diaphragm Pump Offers 40 PSI
- Adjustable Spray Gun Goes from Mist to Stream
- 5' Braided Nylon Hose to Spray Gun
- Ergonomically Designed Tank
- 6" Screw-On Fill Lid for Less Spillage
- Built-In Carry Handle Lid for Easy Transport
- Lance Clips to Lid for Convenient Storage
- Fill-Lid Screen to Prevent Clogging
- Adjustable, Padded Shoulder Straps
- Battery Charger Included
- Up To 30 Gallons on a Single Charge
- Comes in Full Color Retail Box

BPS-REV401



REVOLT 14.4 VOLT CONVERSION (SOLD SEPARATELY)



| Part# | Description |
|--------------|---|
| REVOLT-144-1 | Lithium-Ion Rechargeable Sprayer Conversion Kit |



FEATURES

- Convert a 1.0 GPM sprayer to lithium-ion power.
- All-steel, powder coated battery dock with lighted power indicator switch.
- Rechargeable Revolt 14.4v lithium-ion battery.
- Includes charging cable in retail windowed box.



4 GALLON BACKPACK SPRAYER LI-ION BATTERY



REPLACEMENT BATTERY (SOLD SEPARATELY)

| Part# | Description |
|------------------|--|
| REVOLT-144-B-CSK | 14.4 Volt Battery for Revolt Sprayers & Kits |



www.Valleyind.com
Toll Free 1.800.864.1649
Sales@Valleyind.com

HITCH

GRADE 2 HARDNESS HITCH PINS

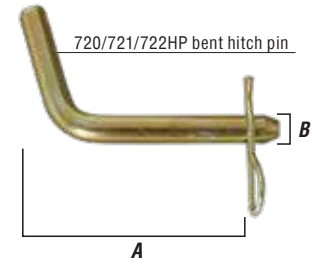
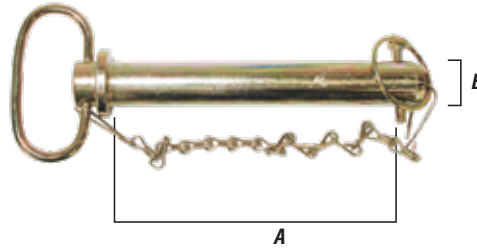

720/721/722HP bent hitch pin

| Part# | Case# | JD# | Farmex# | HH# | Speeco# | Tisco# | A Length | B Pin Dia. |
|--------|---------|---------|---------|-------|----------|--------|----------|------------|
| 700HP | B500176 | TY4012 | 14891 | 29836 | P71032CL | PS7506 | 6¼" | ¾" |
| 701HP | B500177 | TY4013 | 17881 | 29843 | P71042CL | PS8756 | 6¼" | ⅞" |
| 702HP | N/A | TY4009 | 15201 | 29821 | P71021CL | PS6254 | 4¼" | ⅝" |
| 703HP | B500175 | TY4010 | 15211 | 29832 | P71031CL | PS7504 | 4¼" | ¾" |
| 704HP | B500174 | TY15737 | 14881 | 29826 | P71022CL | PS6256 | 6¼" | ⅝" |
| 705HP | B500172 | TY15736 | 22131 | 29810 | P71011CL | PS5004 | 3½" | ½" |
| 706HP | B500178 | N/A | 17891 | 29854 | P71052CL | PS1006 | 6¼" | 1" |
| 707HP | B500179 | N/A | 17901 | 29865 | P71062CL | PS1126 | 6¼" | 1⅞" |
| 708HP | B500180 | N/A | 18001 | 29876 | P71072CL | PS1256 | 6¼" | 1¼" |
| 709HP | N/A | N/A | N/A | N/A | N/A | N/A | 4¼" | ⅞" |
| 713HP* | N/A | N/A | 01789 | 25653 | P71052C | P51006 | 6¼" | 1" |
| 715HP | N/A | N/A | N/A | 29808 | P71010C | N/A | 4¼" | ⅜" |
| 720HP | N/A | N/A | 01410 | 10312 | P71111 | N/A | 3" | ½" |
| 721HP | N/A | N/A | N/A | N/A | N/A | N/A | 3½" | ¾" |
| 722HP | N/A | N/A | 33108 | N/A | P7922 | N/A | 3" | ⅝" |

All of the above hitch pins are Grade 2 hardness. *713HP does not include pin.

RUBBER HANDLED HITCH PINS GRADE 5 & 8 HARDNESS

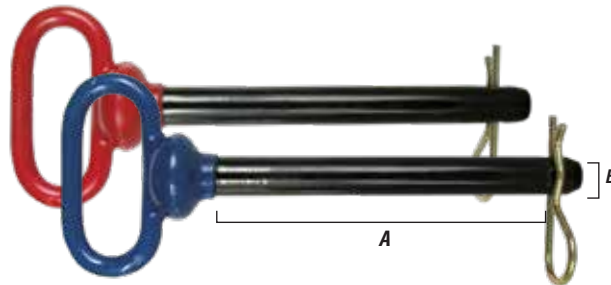

| Part# Red | Part# Blue | Case# | Farmex# | Speeco# | HH# | A Length | B Pin Dia. |
|-----------|------------|---------|---------|---------|-------|----------|------------|
| 705HPR | 705HPBLU | B504050 | 1500 | P700511 | 00113 | 3⅝" | ½" |
| 702HPR | 702HPBLU | B504051 | 1501 | P700521 | 00223 | 4" | ⅝" |
| 703HPR | 703HPBLU | B504053 | 1503 | P700531 | 00233 | 4" | ¾" |
| 700HPR | 700HPBLU | B504054 | 1504 | P700532 | 00133 | 6½" | ¾" |
| 701HPR | 701HPBLU | B504055 | 1506 | P700542 | 00143 | 6½" | ⅞" |
| 706HPR | 706HPBLU | B504056 | 1508 | P700552 | 00153 | 7" | 1" |
| 707HPR | N/A | 8504057 | 1510 | P700562 | 00163 | 8½" | 1⅞" |
| N/A | 707HPBLU | N/A | N/A | N/A | N/A | 7" | 1⅞" |
| 708HPR | 708HPBLU | N/A | 1512 | P700572 | 00173 | 8½" | 1¼" |
| 710HPR | N/A | N/A | N/A | P700522 | N/A | 5½" | ⅝" |
| 715HPR | N/A | N/A | N/A | P700582 | N/A | 8½" | 1½" |

All include rubber coated handle. Red handled are Grade 5 hardness. Blue handled pins are Grade 8 hardness.

PINS

FORGED HITCH PINS

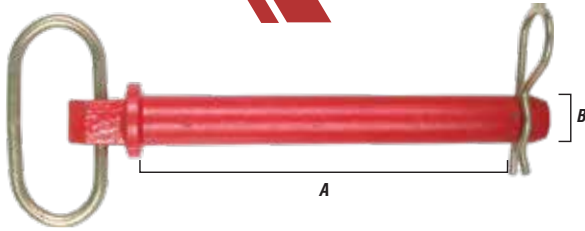

| Part# | A (Length) | B (Pin Dia.) | Part# | A (Length) | B (Pin Dia.) |
|--------|------------|--------------|--------|------------|--------------|
| 700FHP | 6¼" | ¾" | 705FHP | 3½" | ½" |
| 701FHP | 6½" | ⅞" | 706FHP | 6¾" | 1" |
| 702FHP | 3⅝" | ⅝" | 707FHP | 7" | 1⅛" |
| 703FHP | 4" | ¾" | 708FHP | 7" | 1¼" |

SPRING SNAP-LOCK HITCH PINS

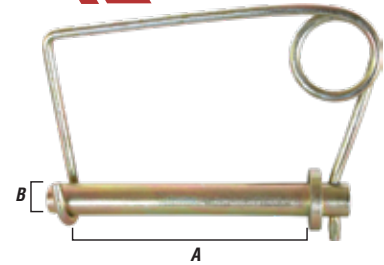

| Part# | A | B |
|-------|------|----|
| 710HP | 4 ½" | ½" |
| 711HP | 4 ½" | ⅝" |
| 712HP | 4¼" | ¾" |

CLEVIS PINS

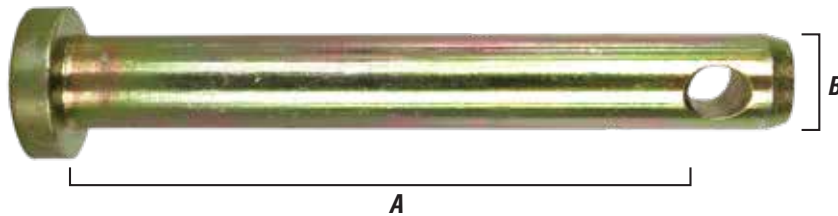

| Part# | OEM# | HH# | A Length | B Pin Diameter |
|-------|-------|-------|----------|----------------|
| 6043 | 17102 | 63797 | 5½" | ¾" |
| 6044 | 17103 | 63836 | 5½" | ⅞" |
| 6045 | 17104 | 63861 | 5¾" | 1" |
| 6046 | 17105 | 63882 | 5¾" | 1⅛" |

TOP LINKS

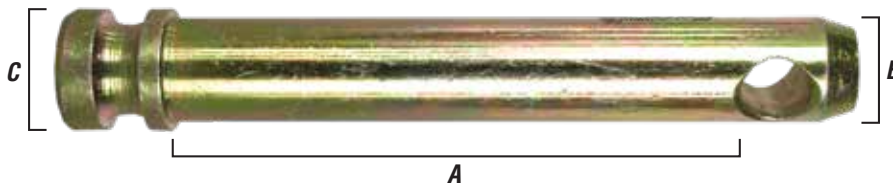

| Part# | Case# | Farmex# | HH# | Speeco# | Tisco# | Model | A Length | B Pin Dia | C Head Size |
|-------|---------|---------|-------|---------|--------|-------|----------|-----------|-------------|
| 104P | B500183 | 03173 | 21250 | P776 | P70706 | Cat 0 | 2¾" | ⅝" | ¾" |
| 105P | B500184 | 00073 | 21252 | P771 | P1010 | Cat 1 | 2¾" | ¾" | ⅞" |
| 106P | B500187 | 00076 | 21260 | P7719 | P12325 | Cat 2 | 3⅜" | 1" | 1⅛" |
| 107P | B500186 | 00074 | 21256 | P773 | P1500 | Cat 3 | 3⅞" | ¾" | ⅞" |
| 108P | B500188 | 03011 | 21262 | P774 | P2450 | Cat 2 | 4⅝" | 1" | 1⅛" |
| 109P | B500189 | 03026 | 21270 | P7711 | P7711 | Cat 3 | 4⅞" | 1¼" | 1⅜" |
| 110P | N/A | 00074 | 21257 | P7715 | N/A | Cat 1 | 4¾" | ¾" | |

IMPLEMENT &

DOUBLE CHAIN CLEVIS



| Part # | Chain Size |
|------------|---------------|
| 64.000.003 | 3/8" |
| 64.000.004 | 1/4" to 5/16" |
| 64.000.005 | 7/16" to 1/2" |

UTILITY CLEVIS



| Part # | Body Size | Pin Dia | Usable Length |
|------------|-----------|---------|---------------|
| 64.400.038 | 3/8" | 7/16" | 1 1/4" |
| 64.400.716 | 7/16" | 1/2" | 1 1/2" |

TWISTED CLEVIS



| Part # | Body Size | Pin Dia | Usable Length |
|------------|-----------|---------|---------------|
| 64.200.058 | 5/8" | 1/2" | 2 1/4" |
| 64.200.075 | 3/4" | 5/8" | 3" |
| 64.200.078 | 7/8" | 3/4" | 3 1/4" |
| 64.201.516 | 15/16" | 7/8" | 3 3/4" |
| 64.200.001 | 1" | 1" | 4 1/4" |

STRAIGHT CLEVIS



| Part # | Body Size | Pin Dia | Usable Length |
|------------|-----------|---------|---------------|
| 64.300.058 | 5/8" | 1/2" | 2 1/4" |
| 64.300.075 | 3/4" | 5/8" | 3" |
| 64.300.078 | 7/8" | 3/4" | 3 1/4" |
| 64.301.516 | 15/16" | 7/8" | 3 3/4" |
| 64.300.001 | 1" | 1" | 4 1/4" |

DRAW BAR HOOK



| Part # | Working Load Limit |
|------------|--------------------|
| 64.038.002 | 9,500 lbs |

IMPLEMENT PINS

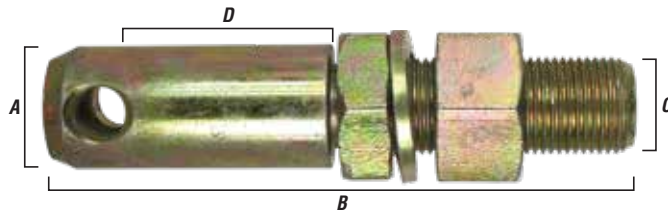

| Part# | Case# | Farmex# | HH# | Speeco# | Tisco# | Size | A Pin Dia. | B Overall Length | C UNF Thread | D Usable Length |
|-------|---------|---------|-------|---------|---------|-----------------------------|------------------|------------------------|--------------------|-----------------------|
| 149IP | B500195 | 03137 | 21210 | P7220 | N/A | Cat 0 Adjustable | 5/8" | 37/8" | 5/8" | 13/16" |
| 150IP | B504050 | 3133 | 21212 | P7221 | N/A | Cat 1-0 Adjustable | 7/8" | 45/8" | 5/8" | 13/16" |
| 151IP | B500196 | 00211 | 21222 | P722 | P2009 | Cat 1 Adjustable | 7/8" | 55/16" | 7/8" | 17/8" |
| 154IP | B500199 | 3001 | 21230 | P724 | P2009XL | Cat 2 Adjustable | 11/8" | 53/16" | 7/8" | 13/16" |
| 159IP | N/A | 3000 | 21233 | P7219 | N/A | Cat 1 Extra Long Adjustable | 7/8" | 61/4" | 7/8" | 2" |
| 161IP | N/A | 3002 | N/A | P721 | N/A | Cat 1 Adjustable | 7/8" | 63/8" | 11/8" | 13/4" |
| 160IP | N/A | 3002 | 21241 | P7249 | P2059 | Cat 2 Adjustable | 11/8" | 53/8" | 11/8" | 21/8" |

CLEVIS PINS

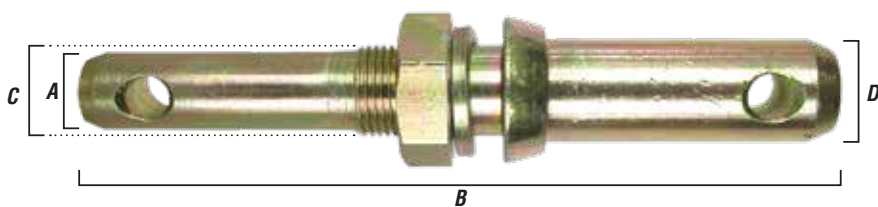

| Part# | Speeco# | Size | HH# | A Pin Dia | B OAL | C UNF Thread | D Pin Dia |
|-------|---------|-----------|-------|--------------|----------|-----------------|--------------|
| 162IP | P726 | Cat 1 & 2 | 21235 | 7/8" | 7 1/2" | 1" | 1 1/8" |

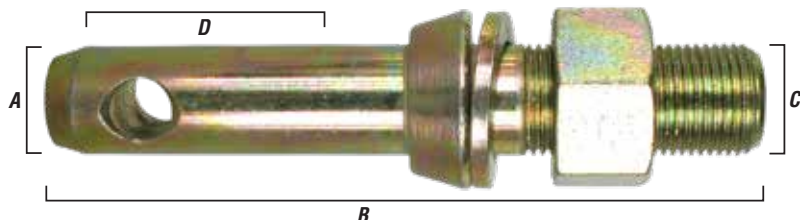

| Part# | Case# | Farmex# | HH# | Speeco# | Tisco# | Size | A Pin Dia. | B OAL | C UNF Thread | D Usable Length |
|-------|---------|---------|-------|---------|---------|-------------------------|---------------|----------|-----------------|--------------------|
| 152IP | B500197 | 00200 | 21226 | P728 | P2000 | Cat 1 Forged | 7/8" | 5 1/2" | 7/8" | 1 3/4" |
| 153IP | B500199 | 3004 | 21224 | P7245 | P2000XL | Cat 1 Extra Long Forged | 7/8" | 6 1/2" | 7/8" | 2 1/4" |
| 155IP | N/A | 00202 | 21232 | P7240 | N/A | Cat 2 Forged | 1 1/8" | 5 1/4" | 7/8" | 1 5/8" |
| 156IP | B500201 | 3178 | 21240 | P7246 | P6502 | Cat 2 Extra Long Forged | 1 1/8" | 6 5/16" | 7/8" | 2 1/4" |
| 157IP | B500202 | 3006 | 21242 | P7212 | N/A | Cat 2 Forged | 1 1/8" | 6 1/4" | 1 1/8" | 1 3/4" |

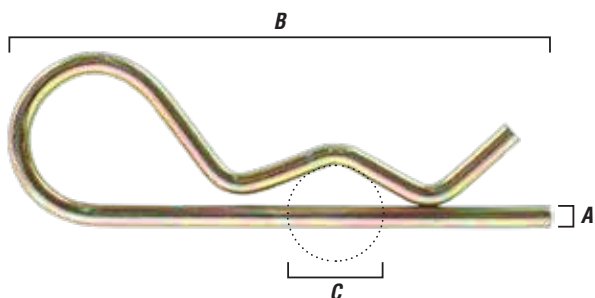

| Part# | Case# | Farmex# | HH# | A Wire Dia | B OAL | C Diameter |
|--------|---------|---------|-------|---------------|--------------|-----------------------|
| P-7922 | N/A | 33108 | 68821 | 2 (1/16") | 42 (1 3/4") | 6-11 (5/16" - 7/16") |
| P-7923 | 00009 | 33109 | 68838 | 2.5 (3/32") | 43 (1 3/4") | 8-12 (7/16" - 9/16") |
| P-7924 | B504905 | 33110 | 68860 | 3 (1/8") | 64 (2 1/2") | 10-18 (9/16" - 3/4") |
| P-7925 | B504906 | 33112 | 68870 | 4 (3/32") | 76 (3") | 12-22 (3/4" - 7/8") |
| P-7927 | B504907 | 33113 | 68880 | 5 (3/16") | 105 (4") | 10-18 (7/8" - 1") |
| P-7928 | N/A | 33114 | 68884 | 6 (7/32") | 123 (4 3/4") | 16-27 (7/8" - 1 1/8") |



LYNCH & LOCK PINS

SQUARE LOCK PINS FOR PTO ADAPTERS

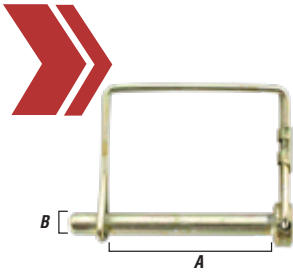

ROUND LOCK PINS FOR PTO ADAPTERS

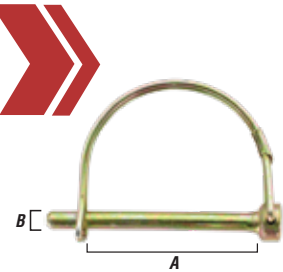

| Part# | Farmex# | Speeco# | HH# | A Length | B Pin Dia. |
|-------|---------|---------|-------|-------------|---------------|
| 904PA | 32276 | P7939 | 21980 | 2 1/4" | 5/16" |
| 905PA | 32275 | P7964 | 21984 | 2 1/4" | 3/8" |

| Part# | Farmex# | Speeco# | HH# | A Length | B Pin Dia. |
|-------|-------------|---------|-------|-------------|---------------|
| 908PA | 32263 | P7938 | 21970 | 1 3/4" | 1/4" |
| 903PA | 00264/32263 | P7951 | 21973 | 2 1/4" | 1/4" |
| 906PA | 32265 | P7941 | 21986 | 2 1/4" | 3/8" |
| 900PA | 00266 | P7940 | 21982 | 2 1/4" | 5/16" |

LYNCH PINS



| | Part# | Case# | Farmex# | Speeco# | HH# | Type | Pin Dia. |
|----------|-------|-----------------------|--------------|---------|-------|-------------------------|----------|
| | 804LP | <i>Replaces 03548</i> | 32204 | N/A | 21910 | Standard Pin | 3/16" |
| | 800LP | B500169 | 32207 | P794 | 21920 | Standard Pin | 1/4" |
| | 802LP | B504901 | 32205 | P7915 | 21930 | Standard Pin | 5/16" |
| 1 | 801LP | B500170 | 2703 | P791 | 21940 | Standard Pin | 7/16" |
| | 803LP | B500171 | 33027 | P7913 | 21960 | Black Ring H.D. | 7/16" |
| | 805LP | N/A | N/A | P7916 | | Standard Pin | 3/8" |
| 2 | 806LP | N/A | N/A | P792 | 21945 | Standard Pin with Chain | 7/16" |

TOP LINKS

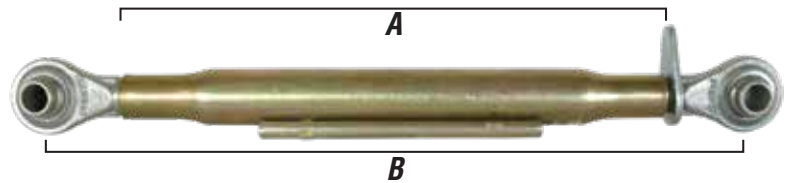

| Part# | Case# | Farmex# | Speeco# | HH# | Size | A Tube Length | B (min) Adj Length | C (max) Adj Length |
|----------|---------|---------|---------|-------|------------------|------------------|-----------------------|-----------------------|
| 204TL | B500219 | 03470 | TL199 | 22506 | Cat 0 | 7 1/2" | 10 1/2" | 16" |
| 205TL | B500219 | 00480 | TL199 | 22508 | Cat 1 Short Tube | 13" | 17 1/2" | 24" |
| 206TL | B500220 | 00332 | TL165 | 22510 | Cat 1 | 16" | 20 1/2" | 31" |
| 206TL-1* | B500220 | 00331 | TL165 | | Cat 1 | 16" | 20 1/2" | 31" |
| 207TL | N/A | 00335 | TL166 | 22512 | Cat 1 | 20" | 24 1/2" | 35" |
| 208TL | N/A | 00338 | TL1670 | 22515 | Cat 1, 2 | 16" | 21 3/4" | 31" |
| 209TL | B500222 | 00340 | TL174 | 22520 | Cat 2 | 16" | 21" | 31 1/2" |
| 209TLHD | N/A | 03473 | N/A | 22525 | Cat 2 Heavy Duty | 15" | 20 1/2" | 31 1/2" |
| 210TL | N/A | 00337 | TL176 | 22522 | Cat 2 | 20" | 25" | 36 1/2" |

* Comes with hex adjuster

BUSHINGS

& PTO ADAPTERS



HITCH BUSHING

Part#

473RB Replaces 03015
Cat 2, 3 reducer. Mounts on Hitch Pin

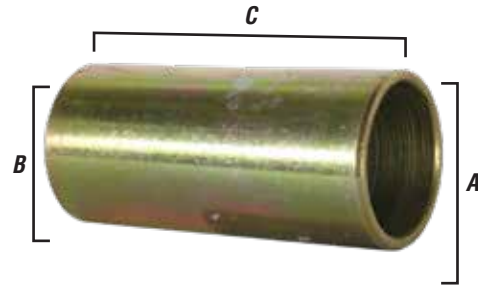

REDUCER BUSHINGS

| Part# | Link | Farmex# | HH# | Speeco# | Tisco# | Size | A Out Dia. | B In Dia. | C Length |
|-------|--------|---------|-------|---------|--------|---------|---------------|--------------|-------------|
| 474RB | Top | N/A | 2118 | B-829 | N/A | Cat 1-0 | 3/4" | 5/8" | 15/8" |
| 478RB | Top | 32250 | 21190 | B-831 | P2007 | Cat 2-1 | 1" | 3/4" | 15/16" |
| 476RB | Top | 33008 | 21192 | B-833 | N/A | Cat 3-2 | 1 1/4" | 1" | 1 3/4" |
| 475RB | Bottom | N/A | 21189 | B-828 | N/A | Cat 1-0 | 7/8" | 5/8" | 1 3/8" |
| 477RB | Bottom | 32252 | 21194 | B-821 | P2007 | Cat 2-1 | 1 1/8" | 7/8" | 1 3/4" |
| 479RB | Bottom | 33009 | 21195 | B-832 | N/A | Cat 3-2 | 1 7/16" | 1 1/8" | 1 3/4" |

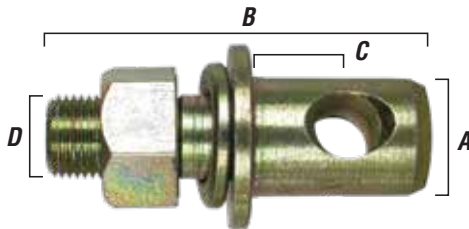

STABILIZER STUB PINS

| Part# | Farmex# | Speeco# | Ford# | HH# | A Hole Size | B OAL | C Usable Length | D UNF Thread |
|-------|---------|---------|--------|-------|----------------|----------|--------------------|-----------------|
| 780P | N/A | P711 | N/A | 21284 | 7/8" | 3 1/4" | 1/2" | 7/8" |
| 781P | 32260 | P781 | 230044 | 21281 | 7/8" | 2 5/8" | 3/8" | 5/8" |
| 785P | 03107 | P785 | 141185 | 21283 | 7/8" | 3 1/8" | 1 1/4" | 5/8" |

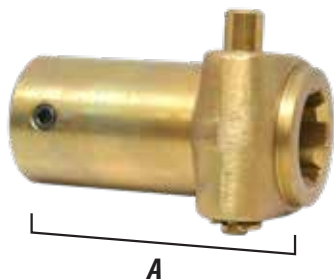

PTO ADAPTERS

| Part# | A | (F)emale | Key | Replacement Pin |
|-------|----------|--------------------------|-------|-----------------|
| 602PA | 4 11/32" | 1 3/8" 6 Spline x 5/8" | 3/16" | 610PA |
| 603PA | 4 11/32" | 1 3/8" 6 Spline x 3/4" | 3/16" | 610PA |
| 605PA | 4 11/32" | 1 3/8" 6 Spline x 15/16" | 1/4" | 610PA |

STABILIZERS & DRAW BARS

LOWER LINK & STABILIZER ARMS

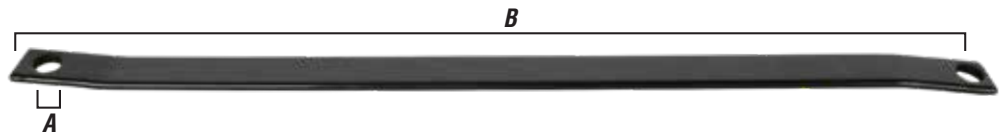

| Part# | Farmex# | HH# | Speeco# | A (Hole Diameter) | B (Length from center) |
|-------|---------|-------|---------|-------------------|------------------------|
| 301S | 00176 | 24176 | SA621 | 7/8" | 31 1/16" |
| 302S | 00177 | 24177 | SA622 | 7/8" | 33 3/8" |

ADJUSTABLE STABILIZER

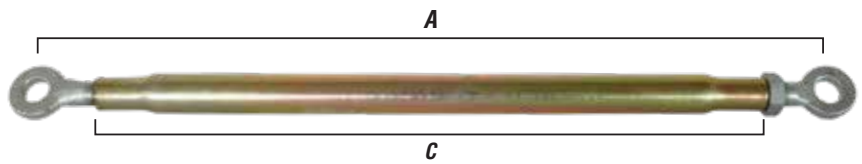

| Part# | Case# | HH# | Speeco# | Tisco# | A min (Adjustable) | B max (Adjustable) | C Tube Length |
|-------------------|---------|-------|--------------|---------|--------------------|--------------------|---------------|
| 300S | B504062 | 24159 | SA-6260 | JSA1003 | 27 1/2" | 35" | 21 7/8" |
| Replacement Parts | | | 72-04-A (LH) | | 72-04-B (RH) | | |

DRAW BARS

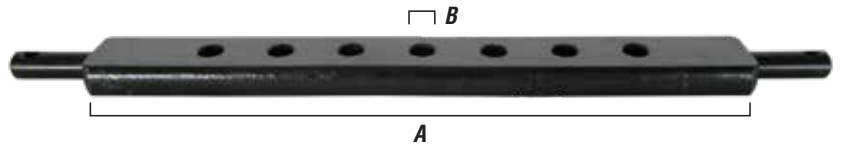

| Part# | Case# | Farmex# | Speeco# | HH# | Size | A Usable Length | B Hole Dia. | C # of Holes |
|--------|---------|---------|---------|-------|------------------|-----------------|-------------|--------------|
| 1005DB | N/A | 10419 | DB-418 | 22718 | Cat 0 | 20" | 5/8" | 7 |
| 1000DB | B500235 | 10419 | DB-419 | 22719 | Cat 1 | 20" | 3/4" | 7 |
| 1002DB | B500236 | 10411 | DB-411 | 22711 | Cat 1 | 26" | 3/4" | 11 |
| 1001DB | B500238 | 10432 | DB-422 | 22732 | Cat 2 | 32" | 3/4" | 13 |
| 1003DB | B500237 | 10421 | DB-421 | 22721 | Cat 2 Heavy Duty | 26" | 3/4" | 11 |

STEERING WHEEL SPINNERS



| Part# | HH# | Description |
|------------|-------|--|
| 67.094.060 | 26951 | Ball bearing style spinner, comes with mounting bracket. |
| 67.095.060 | N/A | Wooden Steering Wheel Spinner |

Wheel Spinners are prepackaged in blister pack.

UNIVERSAL STROKE CONTROL SEGMENTS

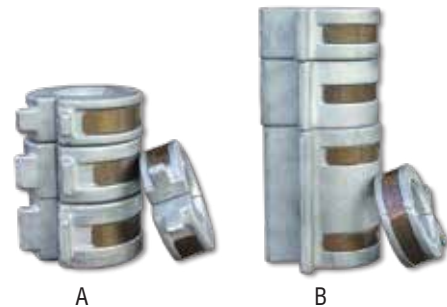

| Part # | Segment Sizes | Cylinder Shaft Sizes | Type |
|------------|----------------------------|----------------------|------|
| 46.999.002 | 7/8", 1", 1-1/4", 1-1/2" | 1-1/8", 1-1/4" | A |
| 46.999.003 | 7/8", 1", 1-1/4", 1-1/2" | 1-3/8", 1-1/2" | A |
| 46.999.004 | 1", 1-1/4", 1-1/2", 1-3/4" | 1-3/4", 1-7/8", 2" | B |

ACCESSORIES

& SECURING PINS

LEVELING LIFT ARM ASSEMBLY



| | |
|--|---------|
| Part# | 350JA |
| Farmex# | 1542 |
| Speeco# | TL175 |
| HH# | 22590 |
| Case# | B504067 |
| Additional Information | |
| 1" Pin, 20" Min Length, 28" Max Length | |

SECURING PIN



| | |
|--------------------------------------|--------|
| Part# | P-7910 |
| Farmex# | 00017 |
| Tisco# | P7910 |
| HH# | 30888 |
| Additional Information | |
| Fits P-7712, P-7713 and 1" hydraulic | |

SECURING PINS

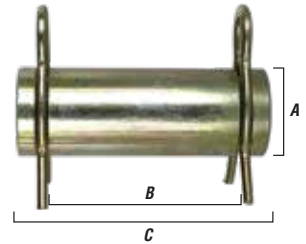

| | | |
|-----------------|----------|----------------|
| Part# | P-7712 | P-7713 |
| Case# | B504952 | N/A |
| Farmex# | 1544 | N/A |
| HH# | 10200 | 10210 |
| Fits | BE350JA | Most 3/8" hyd. |
| Clevis Pin Dia. | A 1" | 1" |
| Usable Length | B 2" | 3 7/8" |
| Overall Length | C 2 3/4" | 3 5/16" |

HEAVY HAULER 3-POINT CARGO BOX

NEW



FEATURES

- Holds up to 750lbs of supplies and materials
- Drop-down legs for smooth mobility in shop or garage
- 2" receiver hitch for additional towing
- Quick hitch & I-match compatible setup

Part# CB-3P-750



9 UNIQUE TOOL HOLDERS
AVAILABLE. VISIT OUR WEBSITE
FOR MORE INFORMATION!

www.Valleyind.com
Toll Free 1.800.864.1649
Sales@Valleyind.com

TRAILER

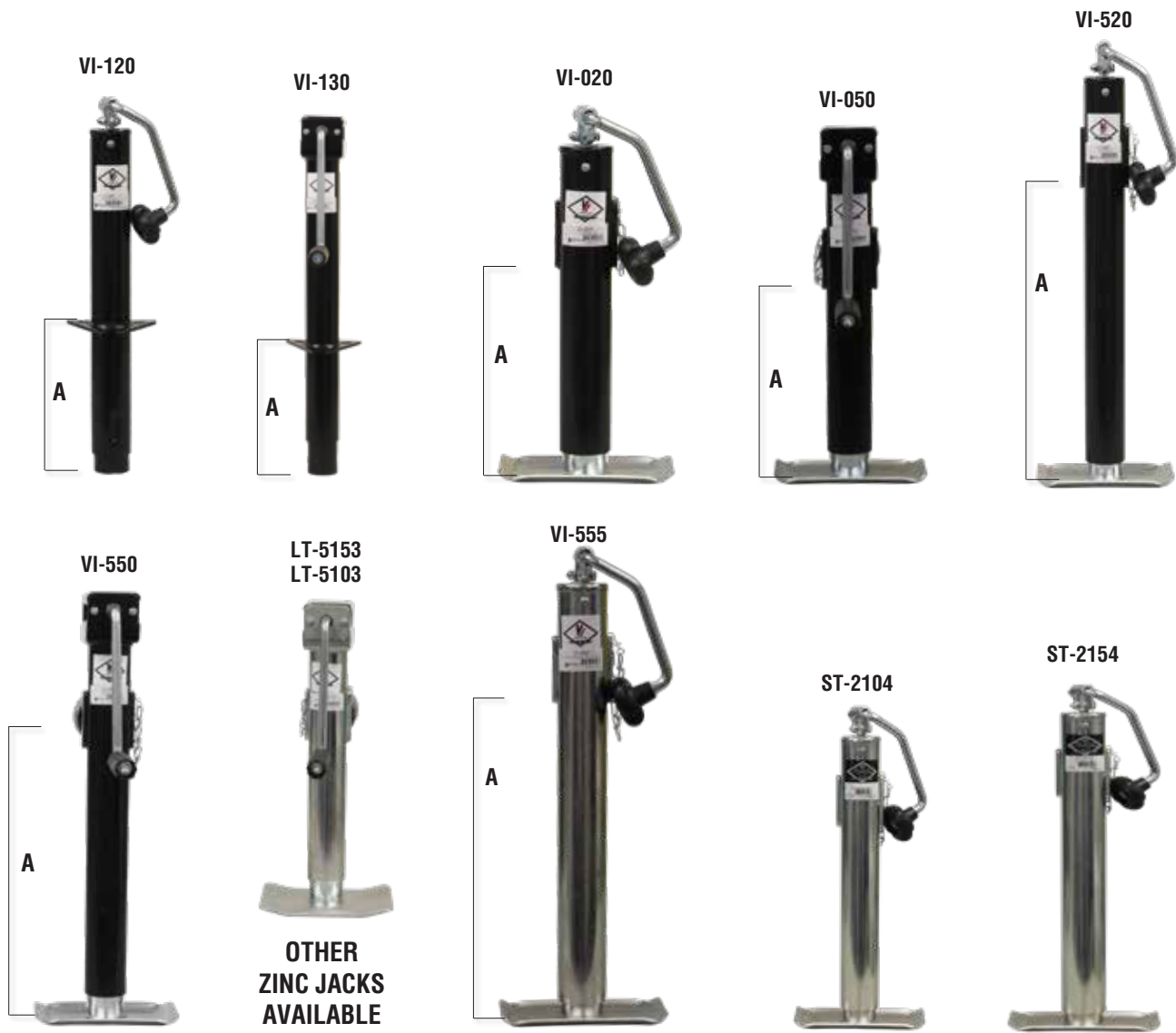

A-FRAME & WELD COLLAR TRAILER JACKS

| Part# | Jack Type | Wind Style | Max Weight | Lift | A (Height) |
|---------|-------------------------|------------|------------|---------|------------|
| VI-120 | A-Frame 3 Hole Flange | Top | 2000 Lbs | 13 1/2" | 7" |
| VI-130 | A-Frame 3 Hole Flange | Side | 2000 Lbs | 13 1/2" | 7" |
| VI-140 | A-Frame, 3 Hole Flange | Top | 5000 Lbs | 13 1/2" | 7" |
| VI-020 | 10" Weld Collar | Top | 2000 Lbs | 10" | 11 1/4" |
| VI-050 | 10" Weld Collar | Side | 5000 Lbs | 10" | 11" |
| VI-520 | 5" Weld Collar | Top | 2000 Lbs | 15" | 15 1/2" |
| VI-550 | 15" Weld Collar | Side | 5000 Lbs | 15" | 15 1/2" |
| VI-555 | Zinc Plated Weld Collar | Top | 5000 Lbs | 15" | 15 1/2" |
| LT-5103 | Zinc Plated Weld Collar | Side | 8000 Lbs | 10" | |
| LT-5153 | Zinc Plated Weld Collar | Side | 8000 Lbs | 15" | |
| ST-2104 | Zinc Plated Weld Collar | Top | 2000 Lbs | 10" | |
| ST-2154 | Zinc Plated Weld Collar | Top | 2000 Lbs | 15" | |

JACKS

FJ-530

FJ-020



TJ-06-01K



TJ-06-02K



TJ-06-06K



TJ-07-51L



VI-720



VI-700



VI-800-EL



VI-1200



VI-1220



FLANGE, WHEEL & HEAVY DUTY TRAILER JACKS

| Part# | Jack Type | Wind Style | Max Weight | Lift |
|------------------|---|------------|------------|--------|
| FJ-020 | Flange | Top | 2000 Lbs | 10" |
| FJ-530 | Flange | Top | 2000 Lbs | 15" |
| TJ-06-01K | Single Wheel | Side | 1200 Lbs | 10" |
| TJ-06-02K | 6" Dual Wheel | Side | 1500 Lbs | 10" |
| TJ-06-06K | 8" HD Wheel | Side | 1500 Lbs | 10" |
| TJ-07-51L | Bolt On, Wheeled, Side Wind, Zinc Plated | Side | 1200 Lbs | 15" |
| HEAVY DUTY JACKS | | Wind Style | Max Weight | Lift |
| VI-720 | HD Square Tubing, with Telescoping Leg | Top | 8000 Lbs | 26" |
| VI-700 | HD Square Tubing, with Telescoping Leg | Side | 8000 Lbs | 26" |
| VI-800-EL | 12V Electric, 18" Lift (24" Lift w/Drop Foot) Boxed | Electric | 3500 Lbs | 18/24" |
| VI-1200 | HD Square Tubing, Telescoping Leg, Includes Handle | Side | 12,000 Lbs | 26" |
| VI-1220 | HD Square Tubing, Telescoping Leg, Includes Handle | Top | 12,000 Lbs | 26" |

TRAILER JACK

COLLAR MOUNT PINS



| Part# | Diameter |
|-----------|----------|
| VI-025-CS | 9/16" |
| VI-027-CS | 5/8" |

REPLACEMENT WHEEL 6" DIAMETER



| Part# | Max Weight | Compatible Valley Jacks |
|-------------|------------|-------------------------|
| TJ-06-04 | 1000 lbs | TJ-06-01K |
| TJ-06-04-CS | 1000 lbs | TJ-06-01K |

A-FRAME WHEEL 6" DIAMETER



| Part# | Max Weight | Compatible Valley Jacks |
|-------------|------------|-------------------------|
| TJ-06-05 | 1000 lbs | All A-Frame Jacks |
| TJ-06-05-CS | 1000 lbs | All A-Frame Jacks |

WELD-ON BRACKET



| Part# | Compatible Valley Jacks |
|-----------|-------------------------|
| VI-701 | VI-700 and VI-720 |
| VI-701-CS | VI-700 and VI-720 |

A-FRAME WHEEL 6" DIAMETER



| Part# | Max Weight | Compatible Valley Jacks |
|-------------|------------|-------------------------|
| TJ-06-02 | 1000 lbs | All A-Frame Jacks |
| TJ-06-02-CS | 1000 lbs | All A-Frame Jacks |

REPLACEMENT HANDLE TOP WIND



| Part# | Compatible Valley Jacks |
|---------------|-------------------------|
| XA.003.999 | All Top Wind Jacks |
| XA.003.999-CS | All Top Wind Jacks |

-CS suffix denotes retail-ready clamshell packaging.

ACCESSORIES

REPLACEMENT HANDLE TOP WIND



| Part# | Compatible Valley Jacks |
|--------|-------------------------|
| VI-704 | VI-720 |

REPLACEMENT HANDLE SIDE WIND



| Part# | Compatible Valley Jacks |
|--------|-------------------------|
| VI-703 | VI-700 |

RETAINING RING



| Part# | Compatible Valley Jacks |
|-------------|-------------------------|
| TJ-06-07-CS | All Flange jacks |

A-FRAME BASE



| Part# | Compatible Valley Jacks |
|-------------|-------------------------|
| TJ-06-03 | VI-120 |
| TJ-06-03-CS | VI-120 |

INNER MOUNTING TUBES



| Part# | Hole Diameter |
|---------------|---------------|
| 64.002.000 | 9/16" |
| 64.002.000-CS | 9/16" |

OUTER MOUNTING TUBES



| Part# | Hole Diameter |
|---------------|---------------|
| 64.003.000 | 9/16" |
| 64.003.000-CS | 9/16" |
| 64.003.058 | 5/8" |
| 64.003.058-CS | 5/8" |

FLANGE MOUNTING KIT



| Part# | Kit Includes |
|--------------|-----------------------------|
| FJ-02-20B | Flange, Pin, Spring & Clips |
| FJ-02-20B-CS | Flange, Pin, Spring & Clips |

-CS suffix denotes retail-ready clamshell packaging.

WINCHES

TRAILER WINCHES 600-2500 LBS



FEATURES



Side Wind
Spring Loaded Hub Lock
Ideal for loading vehicles
and equipment

Bolt Mounted
Metal Tow Hook
Steel construction



TW-600-C08



TW-1000-C10



TW-1400-C10,
TW-1600-C10



TW-1600-S20



TW-2500-C10

REPLACEMENT PARTS



| Part# | Description |
|----------|-------------|
| TW-CAB10 | 10' Cable |
| TW-STP20 | 20' Strap |



RETAIL READY IN FULL COLOR BOXES

| Part# | Max Load | Handle | Ratio | Length |
|-------------|----------|--------|----------------|-----------|
| TW-600-C08 | 600 Lbs | 6.5" | 3.1:1 | 8' Cable |
| TW-1000-C10 | 1000 Lbs | 7.8" | 4.1:1 | 10' Cable |
| TW-1400-C10 | 1400 Lbs | 8.8" | 4.1:1 | 10' Cable |
| TW-1600-C10 | 1600 Lbs | 8.8" | 5.1:1 | 10' Cable |
| TW-1600-S20 | 1600 Lbs | 8.8" | 5.1:1 | 20' Strap |
| TW-2500-C10 | 2500 Lbs | 10.8" | 5.1:1 & 12.1:1 | 10' Cable |

ACCESSORIES

PUMPS, FITTINGS & UTILITY JUGS

3.0 GPM DIAPHRAGM RV PUMP FRESH WATER



| Part# | Port Size | Packaging |
|------------------------|---|-----------|
| EFRV3000-BOX | 1/2" NPSM | Boxed |
| 55 PSI | Polypropylene Housing & Valve Plate | |
| 9.5 Max Amps | Zinc Plated Steel Fasteners | |
| Self Priming to 10' | Painted Steel 5" Motor Shell | |
| CE Approved | Two 1/2" NPS HB Fittings & 1/2" NPS Inline Strainer | |
| Auto Shut-Off | Certified Safe for Drinking Water | |
| Inline Fuse Protection | DXS-3 Valves & Santoprene Diaphragm | |
| | 130° F Max Temperature Rating | |

5.0 GPM DIAPHRAGM RV PUMP FRESH WATER



| Part# | Port Size | Packaging |
|------------------------|---|-----------|
| EFRV5000-BOX | 1/2" NPSM | Boxed |
| 55 PSI | Polypropylene Housing & Valve Plate | |
| 16.0 Max Amps | Zinc Plated Steel Fasteners | |
| Self Priming to 10' | Painted Steel 5" Motor Shell | |
| CE Approved | Two 1/2" NPS HB Fittings & 1/2" NPS Inline Strainer | |
| Auto Shut-Off | Certified Safe for Drinking Water | |
| Inline Fuse Protection | DXS-3 Valves & Santoprene Diaphragm | |
| | 130° F Max Temperature Rating | |



INLINE STRAINER MPTx FPT

| Part# | Description |
|---------------|--------------------------------------|
| EFRV-IS12 | Inline Strainer, 1/2" Ports, 50 Mesh |
| EFRV-IS12-CSK | As above, clamshelled |

HOSE BARB SWIVELS



| Part# | Size | Type |
|-------------|------|----------|
| EFRV-SWA12 | 1/2" | Straight |
| EFRV-SWEL12 | 1/2" | Elbow |

Private Label Opportunity
Available, Call for Details!

UTILITY JUGS 5 GALLON



Pallet Qty: 72
Truck Qty: 1944

| Part# | Color | FEATURES |
|-----------|--------|-------------------------------|
| UJ-05-WHT | White | Vented for easy pouring |
| UJ-05-RED | Red | Chemical resistant HDPE |
| UJ-05-YLW | Yellow | Cap and o-ring seal |
| UJ-05-BLU | Blue | Convenient grip points |
| | | Raised fill markings (1G/5L) |
| | | Customized branding available |

DISCLAIMER: Not a portable fuel container as described by ASTM, EPA, ARB and other official agencies.

ACCESSORIES

NEW

| | |
|---------------|------------------------------|
| UJ-ACC-HB | 45° Angle Hose Bender |
| UJ-ACC-HB-CSK | As Above in Retail Clamshell |
| UJ-ACC-RH | 14" Replacement Hose |
| UJ-ACC-RH-BG | As Above, In Retail Bag |
| UJ-ACC-RL | Replacement Lid with Gasket |

REPLACEMENT PUMPS

PRODUCT PACKAGING LEGEND

The background color of each part number tells you how it is packaged, as shown here:

| |
|-------------------|
| Clamshelled |
| Barcoded or Boxed |
| Bulk Packed |
| Flag Tagged |

16 INCH WATER BROOM UNDER CAR



| | |
|--------------|----------------------------|
| Part# | PK-85400062 |
| Max Pressure | 4,000 PSI |
| Max Flow | 3 GPM |
| Connection | 1/4" Quick-Disconnect plug |
| Nozzles | 4 |

FEATURES

360° Rubber swivel wheels for easy movement.
Made of aluminum alloy and steel for increased durability.
Perfect for cleaning vehicle undercarriages.

12 INCH WATER BROOM THREE NOZZLE



| | |
|--------------|----------------------------|
| Part# | PK-85400060 |
| Max Pressure | 4,000 PSI |
| Max Flow | 3 GPM |
| Connection | 1/4" Quick-Disconnect plug |
| Nozzles | 3 |

FEATURES

360° rubber swivel wheels for easy movement.
Made of aluminum alloy and steel for increased durability.
Perfect for cleaning a wide range of flat surfaces.

PRESSURE WASHER PUMP AXIAL



| | | | |
|-------|-----------|-------|------|
| Part# | PK-AXPUMP | | |
| PSI | 3,100 | Shaft | 3/4" |
| RPM | 3,400 | HP | 4-7 |
| GPM | 2.3 | Motor | Gas |

FEATURES

Bolts-on a 3/4" gas engine shaft.
Pre-installed adjustable unloader and thermal relief valve.
Includes 3-feet of soap tubing with filter.
Made of anodized die-cast aluminum to prevent corrosion.
Includes adapters for universal connections to accessories.

PRESSURE WASHER PUMP TRIPLEX



| | | | |
|-------|------------|-------|------|
| Part# | PK-PSNPUMP | | |
| PSI | 3,700 | Shaft | 1" |
| RPM | 3,400 | HP | 8-13 |
| GPM | 4.0 | Motor | Gas |

FEATURES

Bolts-on a 1" gas engine shaft.
Pre-installed adjustable unloader and thermal relief valve.
Includes 3-feet of soap tubing with filter.
Made of anodized die-cast aluminum to prevent corrosion.
Includes adapters for universal connections to accessories.

SPECIALTY CLEANING

14" FLAT SURFACE CLEANER MULTI-USE



| | |
|---------------|------------------------------------|
| Part# | PK-1400WAW |
| Max. Flow | 4.0 GPM |
| Max .Pressure | 4,000 PSI (Optimal use < 2500 PSI) |
| Max. Temp. | 180°F |

APPLICATIONS

Attach to a long wand and clean hard to reach surfaces.

Attach to a gun and lance for cleaning flat surfaces.

Use a high pressure spray gun kit to clean walls.*



FEATURES

4,000 PSI maximum rotary head. (Optimal use < 2500 PSI)
Durable nylon brush skirt.
Heavy duty polypropylene cover.
Welded steel two arm rotary bar.
Zero wall clearance.

16" FLAT SURFACE CLEANER STAND-UP



| | |
|---------------|---------------------|
| Part# | 8102.2401.00 |
| Max. Flow | 8.0 GPM |
| Max. Pressure | 4,000 PSI |
| Max. Temp. | 180°F |

FEATURES

Easy to handle frame is designed for less operator fatigue.
Welded steel two arm rotary bar.
Heavy duty polypropylene cover.
Welded elbows and assembly.
Durable nylon brush skirt.
Zero wall clearance & water flow out eliminates water build-up.

SANDBLAST KIT WET



| | |
|--------------|----------------|
| Part# | SBK-400 |
| Max Pressure | 3,500 PSI |
| Max Flow | 10 GPM |

FEATURES

Sandblast without the dust of regular sandblasting.
Use to strip paint, remove rust, graffiti, & stains.
Use dry silica sand or #1 grit sand.
Comes with a carbide nozzle for increased durability.
Full color retail box included.

TELESCOPING

WAND & ACCESSORIES

TELESCOPING WANDS



Easily clean gutters, rooftops and hard to reach areas.



Threaded gun for quick removal and easy field repair.



Two aluminum poles and fiberglass outer pole for maximum strength.



Lever locks for firm hold while extended.



Screw type connection for a solid grip on accessories.



| Part# | Max Pressure | Max Flow | Max Temp. | Length | Hose | Weight |
|--------------|--------------|----------|-----------|------------------|------|----------|
| PK-85206012 | 4,000 PSI | 8 GPM | 200°F | 6ft. 6" to 12ft. | 1/4" | 6.5 lbs |
| PK-85206018 | 4,000 PSI | 8 GPM | 200°F | 6ft. 6" to 18ft. | 1/4" | 8.5 lbs |
| PK-85206024L | 4,000 PSI | 8 GPM | 200°F | 9ft. to 24ft. | 1/4" | 10.5 lbs |

TELESCOPING WAND BELT KIT



| Part# | Description |
|-------------|---|
| PK-85400019 | Fits all Valley Long Wands Used to support Long Wands, taking stress off the arms and body. For use with all Long Wands. Fits any size (adjustable). |

TELESCOPING WAND GUTTER CLEANER KITS



| Part# | 8102.1653.00 | | |
|--|-----------------|-----------------|-----------------|
| Part# | PK-85400033 | PK-85400007 | PK-15000002 |
| Max Pressure | 4,000 PSI | 4,000 PSI | 4,000 PSI |
| Outlet | 1/4" QC coupler | 1/4" QC coupler | 1/4" QC coupler |
| Inlet | Male M22 | 1/4" plug | 1/4" Plug |
| Turns wands into efficient gutter cleaners so that gutters can be cleaned from the ground. | | | |

PRESSURE WASHER

SPRAY GUNS



3200 PSI
SPRAY GUN
TRIGGER, FRONT ENTRY

| | |
|-----------------|-------------|
| Part# | PK-12000001 |
| Part# | SG-727 |
| Max Pressure | 3,200 PSI |
| Max Temperature | 210° F |
| Max Flow | 10.5 GPM |
| Outlet | 1/4" FNPT |
| Inlet | 3/8" FNPT |



5000 PSI
SPRAY GUN
TRIGGER, WITH FITTINGS

Use with
2,000 - 5,000 PSI
Pressure washers!

| | |
|-----------------|-------------|
| Part# | PK-85202108 |
| Max Pressure | 5,000 PSI |
| Max Temperature | 210° F |
| Max Flow | 10.5 GPM |
| Outlet | 1/4" FNPT |
| Inlet | 3/8" FNPT |



5000 PSI
SPRAY GUN
TRIGGER

| | |
|-----------------|--------------|
| Part# | PK-SG-970 |
| Part# | 8116.1600.00 |
| Max Pressure | 5,000 PSI |
| Max Temperature | 300° F |
| Max Flow | 10.5 GPM |
| Outlet | 1/4" FNPT |
| Inlet | 3/8" FNPT |



5000 PSI
SPRAY GUN
TRIGGER, WITH FITTINGS

| | |
|-----------------|-------------|
| Part# | PK-1200000M |
| Max Pressure | 5,000 PSI |
| Max Temperature | 210° F |
| Max Flow | 10.5 GPM |
| Outlet | 1/4" FNPT |
| Inlet | 3/8" FNPT |



8108.8617.00



SG-920V

4000 & 4050 PSI
SPRAY GUN
TRIGGER

| | | |
|--|--------------|------------|
| Part# | N/A | PK-SG-920V |
| Part# | 8108.8617.00 | SG-920V |
| Max Pressure | 4,050 PSI | 4,000 PSI |
| Max Temperature | 320° F | 210° F |
| Max Flow | 6.3 GPM | 10.5 GPM |
| Outlet | 1/4" FNPT | 1/4" FNPT |
| Inlet | 3/8" FNPT | 3/8" FNPT |
| Ideal for Hot and Cold water applications. | | |

PROFESSIONAL
SPRAY GUN
KIT



COMPLETE KIT COMES WITH NOZZLES & FITTINGS!

| | |
|---|-----------|
| Part# | PK-340002 |
| Two piece steel lance. | |
| 5,000 PSI rear entry spray gun. | |
| Size 030 - 0°, 15°, 40°, & chemical nozzle. | |
| Male screw-type socket for hose connection. | |
| 3/8" quick connect coupler for hose connection. | |

SPRAY GUN

4000 PSI SPRAY GUN LANCE & FITTINGS



| Part# | PK-SG-850XM |
|-----------------|-----------------|
| Max Pressure | 4,000 PSI |
| Max Temperature | 300° F |
| Max Flow | 8.0 GPM |
| Outlet | 1/4" QC Coupler |
| Inlet | 3/8" FNPT |

FEATURES

- Extended lance with quick connect coupler.
- Includes fittings for universal connection to pressure washer hose:
 - 3/8" QC x MNPT
 - M22 x 3/8" MNPT
 - 1/4" FBSPP x 3/8" MNPT

5000 PSI SPRAY GUN TRIGGER WITH FITTINGS



| Part# | SG-750XU-FT |
|-----------------|-----------------------|
| Max Pressure | 5,000 PSI |
| Max Temperature | 210° F |
| Max Flow | 10.5GPM |
| Outlet | M22 Screw-Type Socket |
| Inlet | 3/8" FNPT |

Comes with 3/8" male QC plug and male screw-type adapters.

PRESSURE WASHER SPRAY GUN KIT ELECTRIC



| Part# | PK-340000 |
|-----------------|---------------------|
| Max Pressure | 2,500 PSI |
| Max Temperature | 140° F |
| Outlet | Female M22 |
| Inlet | Male M22 Screw-Type |

FEATURES

- Extended lance with variable nozzle.
- 25-feet of reinforced steel-wire and fabric hose.
- Soap container also included.

PRESSURE WASHER SPRAY GUN KIT GAS



COMPLETE KIT COMES WITH THE FOLLOWING NOZZLES & FITTINGS!

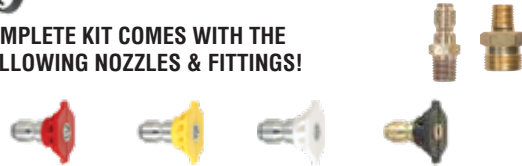

| Part# | PK-340001 |
|-----------------|-----------------|
| Max Pressure | 2,950 PSI |
| Max Temperature | 140° F |
| Outlet | 1/4" QC Coupler |
| Inlet | 3/8" FNPT |

FEATURES

- Extended lance with quick connect coupler.
- Comes complete with 0°, 15°, 40°, and soap nozzles.
- 3/8" QC coupler and M22 screw-type plug for hose connections.
- For gas pressure washers.

MOLDED WAND WITH COUPLER



| Part# | MG-18CA | MG-24CA | MG-36CA | MG-47CA | MG-58CA |
|--------|-----------------|-----------------|-----------------|-----------------|-----------------|
| Length | 18" (450 mm) | 24" (610 mm) | 36" (914 mm) | 47" (1200 mm) | 58" (1475 mm) |
| Outlet | 1/4" QC Coupler | 1/4" QC Coupler | 1/4" QC Coupler | 1/4" QC Coupler | 1/4" QC Coupler |
| Inlet | 1/4" MNPT | 1/4" MNPT | 1/4" MNPT | 1/4" MNPT | 1/4" MNPT |

FEATURES

- Plated steel lance with insulated grip.
- For use with hot or cold pressure washers.

Comes with quick connect coupler.

KITS & WANDS



MOLDED WAND 30° ANGLE WITH COUPLER

| Part# | MG-28BCA | MG-36BCA | MG-59BCA | MG-79BCA |
|--------|-----------------|-----------------|-----------------|-----------------|
| Length | 28" (700 mm) | 36" (900 mm) | 59" (1500 mm) | 79" (2000 mm) |
| Outlet | 1/4" QC Coupler | 1/4" QC Coupler | 1/4" QC Coupler | 1/4" QC Coupler |
| Inlet | 1/4" MNPT | 1/4" MNPT | 1/4" MNPT | 1/4" MNPT |

FEATURES

Plated steel lance with insulated grip
For use with hot or cold pressure washers.

30° angled end with quick connect coupler.



FLEX WAND

| Part# | PK-13000002 | 8102.1900.00 |
|--------|--------------------|---------------------|
| Length | 24" | 24" |
| Outlet | 1/4" MNPT | 1/4" MNPT |
| Inlet | 1/4" MNPT | 1/4" MNPT |
| Color | Blue Rubber Casing | Black Rubber Casing |

SPRAY GUN KIT PRESSURE WASHER 4000 PSI



| Part# | PK-85205026 |
|--------|-----------------|
| Length | 36" (900 mm) |
| Outlet | 1/4" QC Coupler |
| Inlet | 1/4" MNPT |
| PSI | 4,000 |

FEATURES

Plated steel lance w/insulated grip.
Comes with quick connect coupler.
For use with hot or cold water.
Trigger spray gun.

WAND & NOZZLE PRESSURE WASHER VARIABLE



| Part# | TP-VNW18-FT |
|--------|-----------------|
| Length | 18" (450 mm) |
| Outlet | Variable Nozzle |
| Inlet | Male M22 |
| PSI | 3,000 |

FEATURES

Chrome plated steel lance.
Comes with quick connect coupler.
For use with hot or cold water.
140° F maximum temperature.

EXTENSIONS WAND QCxM22



| Part# | TP-QCW16-FT | TP-QCW25-FT |
|--------|-----------------|-----------------|
| Length | 16" | 25" |
| Outlet | 1/4" QC Coupler | 1/4" QC Coupler |
| Inlet | M22 Screw-Type | M22 Screw-Type |

EXTENSIONS MOLDED WAND MNPTxMNPT



| Part# | MG-18 | PK-85202026 | PK-13000000 |
|--------|--------------|--------------|---------------|
| Length | 18" (450 mm) | 36" (900 mm) | 47" (1200 mm) |
| Outlet | 1/4" MNPT | 1/4" MNPT | 1/4" MNPT |
| Inlet | 1/4" MNPT | 1/4" MNPT | 1/4" MNPT |

PACKAGING LEGEND

Clamshelled Bulk Packed
Barcoded or Boxed Flag Tagged



www.Valleyind.com
Toll Free 1.800.864.1649
Sales@Valleyind.com

QA & MEG

ZERO DEGREE QC NOZZLE



Thin, extremely powerful water stream cuts heavy deposits in a small concentrated area. Ideal for cleaning hard to reach areas (e.g. soffit and oil & grease spots).

| Part# | Size |
|--------------|------|
| PK-85201030 | 030 |
| 8113.1030.00 | 030 |
| PK-85201035 | 035 |
| 8113.1035.00 | 035 |
| PK-85201040 | 040 |
| 8113.1040.00 | 040 |
| PK-85201045 | 045 |
| 8113.1045.00 | 045 |
| PK-85201050 | 050 |
| 8113.1050.00 | 050 |

15 DEGREE QC NOZZLE



Narrow water stream used to penetrate heavy deposits in a small area. Ideal for cleaning Brick, Concrete Surfaces, Retaining Walls and Sidewalks.

| Part# | Size |
|--------------|------|
| PK-85216030 | 030 |
| 8113.1030.15 | 030 |
| PK-85216035 | 035 |
| 8113.1035.15 | 035 |
| PK-85216040 | 040 |
| 8113.1040.15 | 040 |
| PK-85216045 | 045 |
| 8113.1045.15 | 045 |
| PK-85216050 | 050 |
| 8113.1050.15 | 050 |

25 DEGREE QC NOZZLE



Medium water stream ideal for cleaning siding, decks, vehicles, and equipment. Ideal for cleaning Brick, Concrete Surfaces, Retaining Walls and Sidewalks.

| Part# | Size |
|--------------|------|
| PK-85226030 | 030 |
| 8113.1030.25 | 030 |
| PK-85226035 | 035 |
| 8113.1035.25 | 035 |
| PK-85226040 | 040 |
| 8113.1040.25 | 040 |
| PK-85226045 | 045 |
| 8113.1045.25 | 045 |
| PK-85226050 | 050 |
| 8113.1050.25 | 050 |

40 DEGREE QC NOZZLE



Wide water stream with a sweeping spray pattern. Ideal for cleaning outdoor furniture, windows, and painted surfaces.

| Part# | Size |
|--------------|------|
| PK-85241030 | 030 |
| 8113.1030.40 | 030 |
| PK-85241035 | 035 |
| 8113.1035.40 | 035 |
| PK-85241040 | 040 |
| 8113.1040.40 | 040 |
| PK-85241045 | 045 |
| 8113.1045.40 | 045 |
| PK-85241050 | 050 |
| 8113.1050.40 | 050 |

QUICK CONNECT SPRAY NOZZLE KIT

| Part# | PK-SZ03SNKIT | PK-SZ04SNKIT | |
|-------|--------------|--------------|-------------|
| Size | 030 | 040 | |
| Type | Gas 4-7 HP | Gas 9-15 HP | |
| Part# | PK-30NZLKIT | PK-35NZLKIT | PK-40NZLKIT |
| Size | 030 | 035 | 040 |
| Type | Pro 4-7 HP | Pro 8-13 HP | Pro 9-15 HP |

FEATURES

Quick connect nozzles kits have a 0°, 15°, 40° & Soaper Nozzle. Fits most pressure washers with a 1/4" quick connect inlet. PK-30NZLKIT & PK-40NZLKIT include nozzle clip & holder. PK-SZ03SNKIT & PK-SZ04SNKIT are clamshelled without holder.



QUICK CONNECT SOAP NOZZLE



| Part# | PK-85266400 |
|-----------------------------------|--------------------|
| Part# | 8113.3160.00 |
| Inlet | 1/4" Quick Connect |
| Material | Brass, Plastic #40 |
| Weight | 0.04 lbs |
| Used to apply soap and chemicals. | |

QUICK CONNECT SOAP NOZZLE LONG RANGE



| Part# | PK-85210009 |
|------------------------|--------------------|
| Inlet | 1/4" Quick Connect |
| SPRAY SOAP UP TO 30FT! | |

NOZZLES

| MATCH PSI TO DESIRED GPM FOR NOZZLE SIZE | | | | | |
|--|-------|-------|-------|-------|-------|
| PSI ▶ | 1,000 | 2,000 | 3,000 | 4,000 | 5,000 |
| Size | GPM ▼ | GPM ▼ | GPM ▼ | GPM ▼ | GPM ▼ |
| 030 | 1.50 | 2.12 | 2.60 | 3.00 | 3.35 |
| 035 | 1.75 | 2.47 | 3.03 | 3.50 | 3.91 |
| 040 | 2.00 | 2.83 | 3.46 | 4.00 | 4.47 |
| 045 | 2.25 | 3.18 | 3.90 | 4.50 | 5.03 |
| 050 | 2.50 | 3.54 | 4.33 | 5.00 | 5.59 |
| 060 | 3.00 | 4.24 | 5.20 | 6.00 | 6.71 |
| 070 | 3.50 | 4.95 | 6.06 | 7.00 | 7.83 |

0 DEGREE MEG NOZZLE 1/4" MNPT



| Part# | Size |
|-------------|------|
| PK-85200030 | 030 |
| PK-85200045 | 045 |

15 DEGREE MEG NOZZLE 1/4" MNPT



| Part# | Size |
|-------------|------|
| PK-85215030 | 030 |
| PK-85215040 | 040 |
| PK-85215045 | 045 |
| PK-85215050 | 050 |
| PK-85215060 | 060 |
| PK-85215070 | 070 |

25 DEGREE MEG NOZZLE 1/4" MNPT



| Part# | Size |
|-------------|------|
| PK-85225030 | 030 |
| PK-85225040 | 040 |
| PK-85225045 | 045 |
| PK-85225050 | 050 |
| PK-85225060 | 060 |
| PK-85225070 | 070 |

40 DEGREE MEG NOZZLE 1/4" MNPT



| Part# | Size |
|-------------|------|
| PK-85240030 | 030 |
| PK-85240040 | 040 |
| PK-85240045 | 045 |
| PK-85240050 | 050 |
| PK-85240060 | 060 |
| PK-85240070 | 070 |

CHEMICAL NOZZLE 1/4" MNPT



| Part# | PK-85240300 |
|-----------------------------------|--------------|
| Part# | 8102.2610.00 |
| Inlet | 1/4" MNPT |
| Material | Brass |
| Weight | 0.04 lbs |
| Used to apply soap and chemicals. | |

MULTI-FUNCTION NOZZLE QUICK CONNECT



Simply Twist to Change Between Spray Patterns!

6 Nozzles in 1

- 0°
- 15°
- 25°
- 40°
- Rinse
- Soap

| Part# | PK-85210601 |
|---|-------------|
| Inlet | 1/4" QC |
| Material | SST |
| FEATURES | |
| 4000 PSI max high pressure nozzle. | |
| Stainless steel for longer life & durability. | |
| Soap and rinse nozzle settings. | |
| 1/4" Quick connect inlet. | |

#3 VARIABLE NOZZLE



| Part# | PK-16000000 |
|--|---------------|
| Max Pressure | 3,000 PSI |
| Max Flow | 1.58-3.12 GPM |
| Size | 1.05mm #3 |
| Max Temp | 140°F |
| Inlet | 1/4" FNPT |
| Nozzle | Brass |
| Best performance with 1,000 to 3,000 PSI pressure washers. | |

VARIABLE & ROTATING NOZZLES

#4 VARIABLE NOZZLE



| | |
|--|-------------------|
| Part# | PK-1600001 |
| Max Pressure | 3,000 PSI |
| Max Flow | 2.00-3.44 GPM |
| Size | 1.20mm #4 |
| Max Temp | 140°F |
| Inlet | 1/4" FNPT |
| Nozzle | Brass |
| Best performance with 1,000 to 3,000 PSI pressure washers. | |

#4.5 VARIABLE NOZZLE



| | |
|--|-------------------|
| Part# | PK-1600002 |
| Max Pressure | 3,000 PSI |
| Max Flow | 2.32-3.96 GPM |
| Size | 1.30mm #4.5 |
| Max Temp | 140°F |
| Inlet | 1/4" FNPT |
| Nozzle | Brass |
| Best performance with 1,000 to 3,000 PSI pressure washers. | |

3000 PSI ROTARY NOZZLE 1/4" FNPT



| | |
|---|---------------------|
| Part# | PK-85210170 |
| Part# | 8111.1440.00 |
| Max Pressure | 3,000 PSI |
| Max Flow | 4.0 GPM |
| Max Temp | 130°F |
| Inlet | 1/4" FNPT |
| Nozzle | Brass |
| Best performance with 1,000 to 3,000 PSI pressure washer. | |

3000 PSI ROTARY NOZZLE 1/4" QC



| | |
|---|---------------------|
| Part# | PK-85210180 |
| Part# | 8111.1471.00 |
| Max Pressure | 3,000 PSI |
| Max Flow | 4.0 GPM |
| Max Temp | 130°F |
| Inlet | 1/4" QC |
| Nozzle | Ceramic |
| Best performance with 2,000 to 3,000 PSI pressure washer. | |
| Built-in easy to clean water filter extends nozzle life. | |

3200 PSI ROTARY NOZZLE 1/4" QC



| | |
|---|-------------------|
| Part# | RJ-3030-CS |
| Part# | RJ-3030-QC |
| Max Pressure | 3,000 PSI |
| Max Flow | 3.2 GPM |
| Max Temp | 130°F |
| Inlet | 1/4" QC |
| Nozzle | Ceramic |
| Best performance with 2,000 to 3,000 PSI pressure washer. | |

3600 PSI ROTARY NOZZLE 1/4" QC



| | |
|---|---------------------|
| Part# | PK-85210190 |
| Part# | 8111.1430.00 |
| Max Pressure | 3,600 PSI |
| Max Flow | 4.0 GPM |
| Max Temp | 130°F |
| Inlet | 1/4" QC |
| Nozzle | Ceramic |
| Best performance with 2,500 to 3,600 PSI pressure washer. | |
| Built-in easy to clean water filter extends nozzle life. | |

3700 PSI ROTARY NOZZLE 1/4" QC



| | |
|--------------|---------------------|
| Part# | PK-RJ-4030 |
| Part# | 8111.1432.00 |
| Max Pressure | 3,700 PSI |
| Max Flow | 4.0 GPM |
| Max Temp | 130°F |
| Inlet | 1/4" QC |
| Nozzle | Ceramic |

4800 PSI ROTARY NOZZLE 1/4" QC



| | |
|---|---------------------|
| Part# | PK-RJ-4048 |
| Part# | 8111.1451.00 |
| Max Pressure | 4,800 PSI |
| Max Flow | 4.0 GPM |
| Max Temp | 130°F |
| Inlet | 1/4" QC |
| Nozzle | Ceramic |
| Best performance with 3,600 to 4,800 PSI pressure washer. | |
| Built-in easy to clean water filter extends nozzle life. | |

5100 PSI ROTARY NOZZLE 1/4" QC



| | |
|--------------|---------------------|
| Part# | PK-RJ-4550 |
| Part# | 8116.1453.00 |
| Max Pressure | 5,100 PSI |
| Max Flow | 4.0 GPM |
| Max Temp | 130°F |
| Inlet | 1/4" QC |
| Nozzle | Ceramic |

PRESSURE WASHER HOSES

2600 PSI HOSE



| | |
|--------------|--------------------|
| Part# | 25TPR14-MIT |
| Max Pressure | 2,600 PSI |
| Diameter | 1/4" |
| Length | 25' |
| Max Temp | 140° F |

FEATURES

Reinforced with steel-wire and fabric.
Complete with M22 screw-type fitting ends.
Includes fittings that connect to Mi-T-M compatible accessories.
Compatible with electric and gas pressure washers.

3600 PSI HOSE



| | |
|--------------|------------------------|
| Part# | PK-85256126-MIT |
| Max Pressure | 3,600 PSI |
| Diameter | 5/16" |
| Length | 25' |
| Max Temp | 140°F |

FEATURES

Reinforced with steel-wire and fabric.
Cut and burn resistant material.
Complete with 3/8" coupler and plug fitting ends.
Includes fittings that connect to Mi-T-M compatible accessories.
Compatible with electric and gas pressure washers.

4000 PSI HOSE



| | |
|--------------|--------------------|
| Part# | PK-85238151 |
| Max Pressure | 4,000 PSI |
| Diameter | 3/8" |
| Length | 50' |
| Max Temp | 200°F |

FEATURES

Reinforced with steel-wire and fabric.
Non-marking, cut and burn resistant material.
6" hose guards with bend restrictors.
Complete with 3/8" coupler and plug fitting ends.
Compatible with gas pressure washers.

4000 PSI NON-MARKING



| | |
|--------------|---------------------|
| Part# | PK-85238155 |
| Part# | 8115.0847.10 |
| Max Pressure | 4,000 PSI |
| Diameter | 3/8" |
| Length | 50' |
| Max Temp | 250°F |

FEATURES

Reinforced with steel-wire and fabric.
Cut and burn resistant material.
6" hose guards with bend restrictors.
Complete with 3/8" coupler and plug fitting ends.
Compatible with gas pressure washers.

PRESSURE WASHER HOSES

4000 PSI HOSE



| | | |
|---|---------------|------------|
| Part# | 30W1-H-BLK | NEW |
| Part# | PK-30W1-H-BLK | |
| Max Pressure | 4,000 PSI | |
| Diameter | 3/8" | |
| Length | 30' | |
| Max Temp | 250°F | |
| FEATURES | | |
| Steel braided rubber hose. 6" hose guards with bend restrictors. Complete with 3/8" MNPT fitting ends. One end with swivel fitting. Compatible with gas pressure washers. | | |

4000 PSI HOSE



| | | |
|---|---------------|------------|
| Part# | 50W1-H-BLK | NEW |
| Part# | PK-50W1-H-BLK | |
| Max Pressure | 4,000 PSI | |
| Diameter | 3/8" | |
| Length | 50' | |
| Max Temp | 250°F | |
| FEATURES | | |
| Steel braided rubber hose. 6" hose guards with bend restrictors. Complete with 3/8" MNPT fitting ends. One end with swivel fitting. Compatible with gas pressure washers. | | |

4000 PSI HOSE



| | | |
|---|---------------|------------|
| Part# | 75W1-H-BLK | NEW |
| Part# | PK-75W1-H-BLK | |
| Max Pressure | 4,000 PSI | |
| Diameter | 3/8" | |
| Length | 75' | |
| Max Temp | 250°F | |
| FEATURES | | |
| Steel braided rubber hose. 6" hose guards with bend restrictors. Complete with 3/8" MNPT fitting ends. One end with swivel fitting. Compatible with gas pressure washers. | | |

4000 PSI HOSE



| | | |
|---|----------------|------------|
| Part# | 100W1-H-BLK | NEW |
| Part# | PK-100W1-H-BLK | |
| Max Pressure | 4,000 PSI | |
| Diameter | 3/8" | |
| Length | 100' | |
| Max Temp | 250°F | |
| FEATURES | | |
| Steel braided rubber hose. 6" hose guards with bend restrictors. Complete with 3/8" MNPT fitting ends. One end with swivel fitting. Compatible with gas pressure washers. | | |

SCREW TYPE FITTINGS

SCREW-TYPE PLUGS MNPTxM22



| | | |
|--------|--------------|--------------|
| Part# | PK-85300132 | PK-85300133 |
| Part# | 8102.6004.00 | 8102.6005.00 |
| Inlet | 1/4" MNPT | 3/8" MNPT |
| Thread | M22 x 1 1/2 | M22 x 1 1/2 |

SCREW-TYPE COUPLER MNPTxM22



| | |
|--------|---------------------------|
| Part# | PK-85300136 |
| Part# | 8102.8521.00 |
| Part# | 8102.6020.00 (1/4" Inlet) |
| Inlet | 3/8" MNPT |
| Thread | M22 x 1 1/2 |

SCREW-TYPE NIPPLE M22xM22



| | |
|-------|---------------------|
| Part# | PK-14000000 |
| Part# | 8102.6006.00 |
| Size | M22 Male x M22 Male |

SCREW-TYPE COUPLER M22xM22



| | |
|-------|----------------------------|
| Part# | PK-14000001 |
| Part# | TC-TC |
| Size | M22 Female x M22 Female |

SCREW-TYPE SOCKET FNPTxM22



| | |
|--------|---------------------------|
| Part# | PK-14000004 |
| Part# | 8102.6001.00 |
| Part# | 8102.6000.00 (1/4" Inlet) |
| Inlet | 3/8" FNPT |
| Thread | M22 x 1 1/2 |

SCREW-TYPE PLUGS FNPTxM22



| | | |
|--------|--------------|--------------|
| Part# | PK-14000009 | PK-14000005 |
| Part# | 8102.6002.00 | 8102.6003.00 |
| Inlet | 1/4" FNPT | 3/8" FNPT |
| Thread | M22 x 1 1/2 | M22 x 1 1/2 |

SCREW-TYPE SOCKET M22xQC



| | |
|-------|-------------------------------|
| Part# | 8102.8518.00 |
| Size | M22 plug x 3/8" QC coupler |

SCREW-TYPE PLUGS M22xQC



| | |
|-------|------------------------------|
| Part# | 8102.8519.00 |
| Size | M22 socket x 3/8" QC plug |

SCREW-TYPE QC SET M22xQC



| | |
|-------------|-------------------------------|
| Part# | PK-14000006 |
| Description | M22 plug x 3/8" QC coupler |

GARDEN HOSE FITTINGS

GARDEN HOSE QC SET



| | |
|--------------|---------------------|
| Part# | PK-14000003 |
| Coupler Size | 3/4" FGHT x 1/2" QC |
| Plug Size | 3/4" MGHT x 1/2" QC |

GARDEN HOSE QC SOCKET



| | |
|-------|---------------------|
| Part# | 8102.0336.00 |
| Size | 3/4" FGHT x 1/2" QC |

GARDEN HOSE QC PLUG



| | |
|-------|---------------------|
| Part# | 8102.0335.00 |
| Size | 3/4" MGHT x 1/2" QC |

GARDEN HOSE ADAPTER



| | |
|--|-----------------------|
| Part# | PK-14000010 |
| Part# | 8105.0502.00 |
| Size | 3/4" FGHT x 1/2" FNPT |
| Assembly includes garden hose adapter and stainless steel mesh filter. | |

O-RINGS & FILTER SET



| | |
|--------------|--------------------------|
| Part# | PK-14000007 |
| Kit Contents | |
| 14mm (x2) | 3/8" (x2) |
| 15mm (x2) | Garden Hose Filters (x2) |
| 1/4" (x2) | (x2) |

O-RINGS & FILTER SET



| | |
|----------------|--------------------------|
| Part# | PK-1400000M |
| Kit Contents | |
| 14mm (x2) | 1/4" (x2) |
| 15mm (x2) | 3/8" (x2) |
| 1/4" BSPP (x2) | Garden Hose Filters (x2) |

O-RING SET



| | |
|--------------|-------------|
| Part# | PK-85400200 |
| Kit Contents | |
| 1/4" (x4) | 3/8" (x2) |

BRASS LIVE SWIVEL



| | |
|-------|-----------------------|
| Part# | PK-14000008 |
| Part# | 8402.3501.00 |
| Size | 3/8" FNPT x 3/8" MNPT |

BRASS REDUCER BUSHING



| | |
|-------|-----------------------|
| Part# | PK-14000002 |
| Part# | 8102.0520.00 |
| Size | 3/8" MNPT x 1/4" FNPT |

SCREW-TYPE ADAPTER



| | |
|-------|------------------------|
| Part# | 8102.0533.00 |
| Size | 1/4" MBSPP x 3/8" FNPT |

SCREW-TYPE PLUG



| | |
|-------|------------------------|
| Part# | PK-81020532 |
| Part# | 8102.0532.00 |
| Size | 1/4" FBSPP x 3/8" MNPT |

QUICK CONNECT FITTINGS

QUICK CONNECT PLUGS FNPTxQC



| Part# | PK-85300101 | PK-85300104 |
|----------|--------------------------|--------------------------|
| Part# | 8102.0320.00 | 8102.0322.00 |
| | 8102.0328.00 (Stainless) | 8102.0330.00 (Stainless) |
| Thread | 1/4" QC x FNPT | 3/8" QC x FNPT |
| Material | Plated Steel | Plated Steel |

QUICK CONNECT PLUGS MNPTxQC



| Part# | PK-85300109 | PK-85300105 |
|----------|--------------------------|--------------------------|
| Part# | 8102.0321.00 | 8102.0323.00 |
| | 8102.0329.00 (Stainless) | 8102.0331.00 (Stainless) |
| Thread | 1/4" QC x MNPT | 3/8" QC x MNPT |
| Material | Plated Steel | Plated Steel |

QUICK CONNECT COUPLERS FNPTxQC



| Part# | PK-85300102 | PK-85300103 |
|----------|--------------------------|--------------------------|
| Part# | 8102.0301.00 | 8102.0302.00 |
| | 8102.0309.00 (Stainless) | 8102.0310.00 (Stainless) |
| Thread | 1/4" QC x FNPT | 3/8" QC x FNPT |
| Material | Brass | Brass |

QUICK CONNECT COUPLERS MNPTxQC



| Part# | PK-85300107 | PK-85300108 |
|----------|--------------------------|--------------------------|
| Part# | 8102.0303.00 | 8102.0304.00 |
| | 8102.0311.00 (Stainless) | 8102.0312.00 (Stainless) |
| Thread | 1/4" QC x MNPT | 3/8" QC x MNPT |
| Material | Brass | Brass |

3/8" QUICK CONNECT COUPLER KIT



| Part# | PK-85400201 |
|--------------|--|
| Kit Contents | 3/8" QC x FNPT plated steel plug 3/8" QC x FNPT brass coupler |

1/4" & 3/8" QUICK CONNECT COUPLER KIT



1/4" QUICK CONNECT COUPLER KIT



| Part# | PK-14000202 |
|--------------|--|
| Kit Contents | 1/4" QC x MNPT plated steel plug 1/4" QC x FNPT brass coupler |

| Part# | PK-85400202 |
|--------------|--|
| Kit Contents | 1/4" QC x FNPT plated steel plug 1/4" QC x FNPT brass coupler 3/8" QC x FNPT plated steel plug 3/8" QC x FNPT brass coupler |

QUICK CONNECT FITTINGS

1/2" QUICK CONNECT COUPLERS



| | | |
|--------|------------------------|------------------------|
| Part# | 8102.0357.00 (Brass) | 8102.0356.00 (Brass) |
| | QC-308SS (Stainless) | QC-308MSS (Stainless) |
| Thread | 1/2" QC Coupler x FNPT | 1/2" QC Coupler x MNPT |

1/2" QUICK CONNECT PLUGS



| | | |
|--------|-----------------------------|-----------------------------|
| Part# | 8102.0355.00 (Plated Steel) | 8102.0354.00 (Plated Steel) |
| | QC-318SS (Stainless) | QC-318MSS (Stainless) |
| Thread | 1/2" QC Plug x FNPT | 1/2" QC Plug x MNPT |

90° PIVOT COUPLER QUICK CONNECT



| | |
|-------------|---|
| Part# | PK-85300172 |
| Part# | QC-304P |
| Description | Brass Male QC Plug and Coupler with 90 Degree Pivot |

CHEMICAL HOSE ASSEMBLY



| | |
|---|--------------|
| Part# | PK-15000000 |
| Part# | 8102.3000.00 |
| Length | 3' |
| Comes with 3 ft hose & chemical suction filter. | |

INLET FILTER CLEAR BOWL



| | |
|---|---------------------------|
| Part# | PK-85300055 |
| Part# | 8102.0461.00 |
| Max Flow | 8 GPM |
| Max Temperature | 175°F |
| Inlet | 3/4" FGHT |
| Outlet | 1/2" MNPT |
| Port | Dual 1/4" FNPT with plugs |
| Protects the pump for contaminants in the water. Clear bowl to easily view filter. | |

CHEMICAL INJECTOR KITS



| | | |
|--|----------------------------------|-----------------------------------|
| Part# | PK-85400003 | PK-85400001 |
| Part# | 85400003 | CHEMK-DN |
| Description | High Pressure Up Stream Injector | Low Pressure Down Stream Injector |
| Max Pressure | 3,500 PSI | 3,500 PSI |
| Max Temperature | 180°F | 180°F |
| Max Flow | 8 GPM | 3.5 GPM |
| Used to provide chemical discharge at pressure washers maximum pressure. | | |

PRESSURE WASHER ACCESSORIES



← PRESSURE GAUGE 2.5" KIT

| | |
|---------------------|--------------------|
| Part# | PK-QCG-5000 |
| Max Pressure | 5,000 PSI |
| Size | 2.5" |
| Inlet | 3/8" QC plug |
| Outlet | 3/8" QC coupler |

Accurately view pressure for all units up to 5,000 PSI.

← SUCTION FILTERS 1/4" HOSE BARB



Low pressure soap suction filters keep contaminants from entering your pump.

| | | |
|--------------------|----------------|-----------------|
| Part# | CF-GREY | CF-BLKSS |
| Hose Barb | 1/4" | 1/4" |
| Check Valve | Yes | No |
| Finish | Plastic | Plastic |



← PREMIUM PUMP OIL 32 OZ

| | |
|-----------------|---|
| Part# | PK-85490000 |
| FEATURES | <ul style="list-style-type: none"> Heavy-duty oil to keep pump running smooth. Non-detergent & non-foaming for superior oxidation protection. Simplified pouring with easy fill neck. Compatible with Comet and other industrial pumps. |



← PUMP SAVER ANTIFREEZE 16 OZ

| | |
|-----------------|--|
| Part# | PK-85490046 |
| FEATURES | <ul style="list-style-type: none"> Lubricates and conditions pump, seals, and extends pump life. Protects your pump from freezing over the winter. |



← SAE 10W-30 MOTOR OIL 32 OZ

| | |
|-----------------|--|
| Part# | PK-85490002 |
| FEATURES | <ul style="list-style-type: none"> Heavy-duty synthetic oil formula for better wear control. Advanced additives for broad temperature ranges. Simplified pouring with easy fill neck. Compatible with wide range of 4-cycle gas engines. |

← PRESSURE WASHER STARTER KIT



| | |
|---------------------|---|
| Part# | PK-PWKIT |
| Kit Contents | <ul style="list-style-type: none"> 32oz. Pump Oil 32oz. Motor Oil 16oz. Pump Saver Nozzle Holder Garden Hose Adapter |

PRESSURE WASHER

ACCESSORIES

INLET FILTER WATER



| | |
|--|---------------------------|
| Part# | PK-85300058 |
| Part# | 8102.0401.00 |
| Max Flow | 10 GPM |
| Max Temperature | 180°F |
| Inlet | 3/4" FGHT |
| Outlet | 1/2" MNPT |
| Ports | Dual 1/4" FNPT with plugs |
| Protects the pump for contaminants in the water. Cap easily unscrews with an allen key to clean out screen. | |

GARDEN HOSE ADAPTER QUICK CONNECT



| | |
|--|--------------------|
| Part# | PK-14000014 |
| Part# | GHF-QC-BLU |
| FEATURES | |
| Connects garden hose to inlet of pressure washer. Built-in filter protects from unwanted debris. Quick attach setup for hassle free attachment. Compatible with most electric pressure washers. | |

24 VOLT WIRE HARNESS EYELET CONNECTORS



| | |
|--------------------|-----------------------------|
| Part# | 33-103947-BOX |
| Length | 6 Feet |
| Gauge | 12 |
| Volts | 24 |
| Fuse | 30 Amp |
| Connections | SAE, 2-Pin & Battery Eyelet |

FOAM CANNON QUICK CONNECT



| | |
|---|-----------------|
| Part# | FMR-5000 |
| Max Pressure | 5000 PSI |
| FEATURES | |
| Adjustable nozzle goes from steady stream to wide-angle pattern. Water regulator knob that controls thickness of foam. Translucent liter bottle with raised volume markings. Wide mouth opening for easy filling. Includes connection fittings to connect with spray guns and lances. | |

SOFT WASH

Visit www.everflo.com for more info.

MOTOR SHIELD PROTECTION

Exclusive patent-pending Motor Shield technology automatically shuts the pump off if a leak is detected. This protects the motor from damage and allows for an easy and low-cost pump head replacement.

SOFT WASH PUMP
2.2 GPM



SOFT WASH PUMP
4.0 GPM



| Part# | Port Type | Packaging |
|--------------|---------------------------------------|-----------|
| EFSW2200-BOX | Quick Attach | Boxed |
| EFSW2200CT | Replacement Head Kit for EFSW2200-BOX | |

FEATURES

| | |
|--------------------|--|
| 70 PSI | Polypropylene Housing & Valve Plate |
| 8.0 Max Amps | Zinc Plated Steel Fasteners |
| Self Priming to 8' | Painted Steel 5" Motor Shell |
| CE Approved | QA x 3/8" HB & QA x 1/2" MNPT Fittings |
| Auto Shut-Off | Motor Shield Protection |

| Part# | Port Type | Packaging |
|--------------|---------------------------------------|-----------|
| EFSW4000-BOX | Quick Attach | Boxed |
| EFSW4000CT | Replacement Head Kit for EFSW4000-BOX | |

FEATURES

| | |
|---------------------|--|
| 60 PSI | Polypropylene Housing & Valve Plate |
| 13.0 Max Amps | Zinc Plated Steel Fasteners |
| Self Priming to 12' | Painted Steel 5" Motor Shell |
| CE Approved | QA x 1/2" HB & QA x 1/2" MNPT Fittings |
| Auto Shut-Off | Motor Shield Protection |

SOFT WASH PUMP
5.5 GPM



SOFT WASH PUMP
10.0 GPM



| Part# | Port Type | Packaging |
|--------------|---------------------------------------|-----------|
| EFSW5500-BOX | Quick Attach | Boxed |
| EFSW5500CT | Replacement Head Kit for EFSW5500-BOX | |

FEATURES

| | |
|---------------------|--|
| 60 PSI | Polypropylene Housing & Valve Plate |
| 17.0 Max Amps | Zinc Plated Steel Fasteners |
| Self Priming to 12' | Painted Steel 5" Motor Shell |
| CE Approved | QA x 3/4" HB & QA x 1/2" MNPT Fittings |
| Auto Shut-Off | Motor Shield Protection |

| Part# | Port Type | Packaging |
|---------------|--|-----------|
| EFSW10000-BOX | Quick Attach | Boxed |
| EFSW10000CT | Replacement Head Kit for EFSW10000-BOX | |

FEATURES

| | |
|---------------------|-------------------------------------|
| 100 PSI | Polypropylene Housing & Valve Plate |
| 25.0 Max Amps | Zinc Plated Steel Fasteners |
| Self Priming to 10' | Painted Steel 5" Motor Shell |
| CE Approved | Fittings & Plumbing Included |
| Auto Shut-Off | Motor Shield Protection |

PACKAGING LEGEND

| | |
|-------------------|-------------|
| Clamshelled | Bulk Packed |
| Barcoded or Boxed | Flag Tagged |

www.Valleyind.com
Toll Free 1.800.864.1649
Sales@Valleyind.com

SOFT WASH



SOFT WASH
SPRAY GUN
 (SOLD SEPARATELY)



| Part# | Description |
|-----------------|--------------------------------------|
| 8108.7212.00 | Soft Wash Spray Gun w/QA Outlet |
| FEATURES | |
| 217 PSI Max | 31.2 GPM Max 24" Barrel Length |
| 125° F Max | 1/2" FPT Inlet 1/4" Female QC Outlet |
| Part# | Description |
| 8108.7212.01 | Rebuild Kit for 8108.7212.00 |

SYSTEM



12 GALLON SOFT WASH **SPRAYER** RECHARGEABLE

FEATURES SWI-09-012S-VI

- Lead-acid rechargeable battery.
- 12 gallon chemical resistant tank.
- 2.2 GPM Everflo pump offers 70 PSI
- Powder coated, all-steel frame.
- All-steel hose organizing rack.
- Rugged, never-flat wheels.
- Deluxe, quick-connect spray gun.
- 30' of chemical resistant braided nylon hose.
- Raised volume indicators for easy filling and fluid monitoring.
- Motor Shield Protection shuts pump off if a leak is detected.
- 5" recessed screw-on fill lid with tether for less spillage.
- Battery charger included.
- Mold-in drain with tethered cap.



PACKAGING LEGEND

| | |
|-------------------|-------------|
| Clamshelled | Bulk Packed |
| Barcoded or Boxed | Flag Tagged |



www.Valleyind.com
Toll Free 1.800.864.1649
Sales@Valleyind.com

RECHARGEABLE DISINFECTANT

SPRAYER



FEATURES SW6-09-012N-VI

- 12 gallon chemical resistant tank.
- 1.1 gpm Everflo pump offers 40PSI.
- Rechargeable 14.4 volt lithium-ion battery.
- Powder coated, all-steel frame.
- All-steel hose organizing rack.
- Rugged, never-flat wheels.
- Quick-grip misting spray gun.
- 30' of chemical resistant braided nylon hose.
- Raised volume indicators for easy filling and fluid monitoring.
- Up to 30 gallons on a single charge.
- 5" recessed screw-on fill lid with tether for less spillage.
- Battery charger included.
- Mold-in drain with tethered cap.

PRESSURE WASHERS



ELECTRIC RESIDENTIAL PRESSURE WASHER 1.5 HP & 1500 PSI

| | |
|-----------------|--|
| Engine | Powerase Electric |
| HP | 1.5 HP |
| PSI | 1500 |
| Max Flow | 1.6 GPM |
| Mount | Wall Mount |
| Other Features: | Commercial Grade Steel Frame Triplex Brass Head Pump Auto On/Off w/Trigger Activation 50' Steel Braided Rubber Hose 36" Insulated Lance 4 QC Spray Tips |

Powerase
engines



GASOLINE FARM & RANCH PRESSURE WASHER 223CC & 3400 PSI

| | |
|-----------------|--|
| Engine | Powerase |
| HP | 7.0 HP |
| PSI | 3400 |
| Max Flow | 2.4 GPM |
| Drive | Horizontal |
| Other Features: | 10" Tires Chemical Injector 25' Rubber Hose 36" Insulated Lance 4 QC Spray Tips Steel Powder Coated Frame |

Powerase
engines



PRESSURE **WASHERS**



INDUSTRIAL GASOLINE **PRESSURE WASHER** 270CC & 3800 PSI

| | |
|------------------------|--|
| Engine | Honda GX270 Series |
| CC | 270 |
| PSI | 3800 |
| Max Flow | 3.5 GPM |
| Drive | Horizontal |
| Other Features: | Threaded Axle 12" Pneumatic Tires 50' Steel Braided Rubber Hose 36" Insulated Lance 4 QC Spray Tips Commercial Grade Steel Powder Coated Frame |

POWERED by **HONDA**



INDUSTRIAL GASOLINE **PRESSURE WASHER** 420CC & 4000 PSI

| | |
|------------------------|---|
| Engine | Powercase w/Oil Alert |
| CC | 420 |
| PSI | 4000 |
| Max Flow | 4.0 GPM |
| Drive | Horizontal |
| Other Features: | Threaded Axle 12" Pneumatic Tires Chemical Injector 50' Steel Braided Rubber Hose 36" Insulated Lance 4 QC Spray Tips Commercial Grade Steel Powder Coated Frame |

Powercase
engines



WATER PUMPS

5.0 HP & 158 GPM WATER PUMP



FEATURES

| | |
|-----------------|-----------------|
| Output Diameter | 2 Inch |
| Engine | 5.0 HP Honda GX |
| Max Flow | 158 GPM |
| Start Type | Pull Start |

6.5 HP & 126 GPM WATER PUMP



FEATURES

| | |
|-----------------|-----------------|
| Output Diameter | 2 Inch |
| Engine | 6.5 HP Honda GX |
| Max Flow | 126 GPM |
| Start Type | Pull Start |

7.0 HP & 158 GPM WATER PUMP



FEATURES

| | |
|--|------------------|
| Output Diameter | 2 Inch |
| Engine | 7.0 HP Powerease |
| Max Flow | 158 GPM |
| Start Type | Pull Start |
| C.A.R.B. Approved Engine Also Available. | |

WATER & TRASH PUMPS

WATER PUMP

6.5 HP & 264 GPM



FEATURES

| | |
|-----------------|--------------|
| Output Diameter | 3 Inch |
| Engine | 6.5 HP Honda |
| Max Flow | 264 GPM |
| Start Type | Pull Start |

WATER PUMP

7.0 HP & 264 GPM



FEATURES

| | |
|--|------------------|
| Output Diameter | 3 Inch |
| Engine | 7.0 HP Powerease |
| Max Flow | 264 GPM |
| Start Type | Pull Start |
| C.A.R.B. Approved Engine Also Available. | |

WATER PUMP

8.0 HP & 286 GPM



FEATURES

| | |
|-----------------|--------------|
| Output Diameter | 3 Inch |
| Engine | 8.0 HP Honda |
| Max Flow | 286 GPM |
| Start Type | Pull Start |

WATER PUMP

13.0 HP & 506 GPM



FEATURES

| | |
|-----------------|---------------|
| Output Diameter | 4 Inch |
| Engine | 13.0 HP Honda |
| Max Flow | 506 GPM |
| Start Type | Pull Start |

GASOLINE GENERATORS

GENERATOR FEATURES

- Powder coated steel roll cage
- Automatic low oil-shutdown that safeguards engine
- Accessible outlets protected by circuit breakers for safety
- LED floodlight for reliable illumination
- Sub-zero technology to start in cold conditions
- Automatic CO detector shuts-down generator before harmful levels of carbon monoxide
- Comes with folded handles and wheels
- 2-year warranty on engine
- 1-year warranty on electric

4800 WATT GENERATOR 223CC



SPECIFICATIONS

| | |
|-------------------------------------|-----------------|
| Engine | Powerease |
| Displacement | 223cc |
| AC Max Output | 4800 |
| AC Continuous Output | 3600 |
| Receptacles: | |
| 2 x Duplex 20 A 120 V (L5-20R) GFCI | |
| 1 x 120 V / 240V Twist (L14-30R) | |
| Starting System | Recoil |
| Fuel Capacity | 3.9 Gallons |
| Run Time | 11HR @ 1/2 Load |
| Weight | 103lbs |

7000 WATT GENERATOR 312CC



SPECIFICATIONS

| | |
|------------------------------------|-------------------|
| Engine | Powerease |
| Displacement | 312cc |
| AC Max Output | 7000 |
| AC Continuous Output | 5500 |
| Receptacles: | |
| 3 x Duplex 20 A 120V (L5-20R) GFCI | |
| 1 x 120 V / 240V Twist (L14-30R) | |
| 1 x 12V Auxilliary | |
| Starting System | Recoil |
| Fuel Capacity | 5.3 Gallons |
| Run Time | 13.3HR @ 1/2 Load |
| Noise Level | 69dB |
| Weight | 150lbs |

9000 WATT GENERATOR 389CC



SPECIFICATIONS

| | |
|-----------------------------------|----------------|
| Engine | Powerease |
| Displacement | 389cc |
| AC Max Output | 9000 |
| AC Continuous Output | 6300 |
| Receptacles: | |
| 3 x Duplex 20A 120V (L5-20R) GFCI | |
| 1 x 120 V / 240V Twist (L14-30R) | |
| 1 x 12V Auxilliary | |
| Starting System | Recoil |
| Fuel Capacity | 6.6 Gallons |
| Run Time | 8HR @ 1/2 Load |
| Noise Level | 67dB |
| Weight | 193lbs |

WARRANTY

& RETURN INFORMATION

WARRANTY

This warranty is in lieu of all other warranties, expressed or implied. Valley Industries warrants that all products sold shall be free from defects in workmanship and material when used within the service and scope for which they were designed.

Such warranty shall apply for a period of one year after the shipment of the product unless otherwise noted. If at any time within this period, it is established to the satisfaction of Valley Industries that the product was defective at time of shipment, Valley Industries, at its option, shall furnish replacements of, or repair the product(s).

It is understood that the liability of Valley Industries shall be limited to such repair or replacement and that Valley Industries shall not be liable for any direct or consequential damages arising out of any defects or from any cause whatsoever. This warranty does not cover deterioration by normal wear and tear or any other cause of failure other than defects in workmanship and material as previously outlined.

Unless repairs to, alterations of, or work done on the product by the purchaser is specifically authorized in writing by Valley Industries, any warranty applicable to the product shall become null and void.

RETURNED GOODS

Valley Industries will make every effort possible to rectify errors which result in items being returned for credit. Valley Industries requires a return authorization number and a copy of the packing list with all returned goods.

A restocking charge may apply.

Our goal is to provide you with prompt and correct credit or replacement. Special Order Products may not be returned.

SPECIFICATIONS

The design specifications found within this catalog are subject to change without notice.



2025 PRODUCT CATALOG



Agricultural Sprayers, Accessories & Components.

www.master-mfg.com



Diaphragm and High Pressure Plunger Pumps & Accessories.

www.cometpump.com



12 Volt DC Diaphragm Pumps & Accessories.

www.everflo pump.com



Agricultural Mist Sprayers & Accessories.

www.mistsprayers.com



Professional Ag Sprayers, Attachments, & Accessories.

www.bestwayag.com



*PRODUCT FEATURES
AND AVAILABILITY
SUBJECT TO CHANGE
WITHOUT NOTICE*

www.Valleyind.com
Toll Free 1.800.864.1649
Sales@Valleyind.com

VI-CATALOG-2025

Valley Industries
180 Lake Ave N
Paynesville, MN 56303